

MARIUSZ MISZTAŁ

TESTS IN ENGLISH

THEMATIC VOCABULARY



CONTENTS

ACKNOWLEDGEMENTS	5
INTRODUCTION	5
TO THE TEACHER	7
TO THE STUDENT	8
HOW TO WORK WITH THIS BOOK	9

TESTS

I. AIR TRAVEL	11
II. ANIMALS	16
III. ARMY	29
IV. CLOTHING	36
V. CRIME AND PUNISHMENT	58
VI. EDUCATION	70
VII. FOOD, COOKING AND RESTAURANTS	97
VIII. GARDENING	118
IX. HEALTH AND MEDICINE	124
X. HISTORY	162
XI. HOUSE AND HOME	171
XII. MONEY AND BANKING	203
XIII. PLANTS	211
XIV. POST OFFICE AND TELEPHONES	218
XV. RELIGION	223
XVI. SEA TRAVEL	229
XVII. SHOPPING	236
XVIII. SOCIALIZING AND PASTIMES	254
XIX. SPORTS	281
KEY	289
INDEX	344

Tests

I. Air Travel



Johnny was making his first plane flight. The plane was up about 5,000 metres when the pilot sent it into a nose dive; it was headed straight for the city below. Pulling out of the dive, the pilot turned to Johnny and laughed:

"I bet fifty per cent of those people down there thought we were going to crash."

"Yes," said Johnny, "and I'll bet fifty per cent of the people up here thought so, too."

*

Air Hostess: "You'll have to change twice, in Frankfurt and in New York, before you get to Los Angeles."

Hick From The Country: "Goodness me! And I've only brought the clothes I'm standing up in!"

1. AIR TRAVEL. Match the names with the pictures.

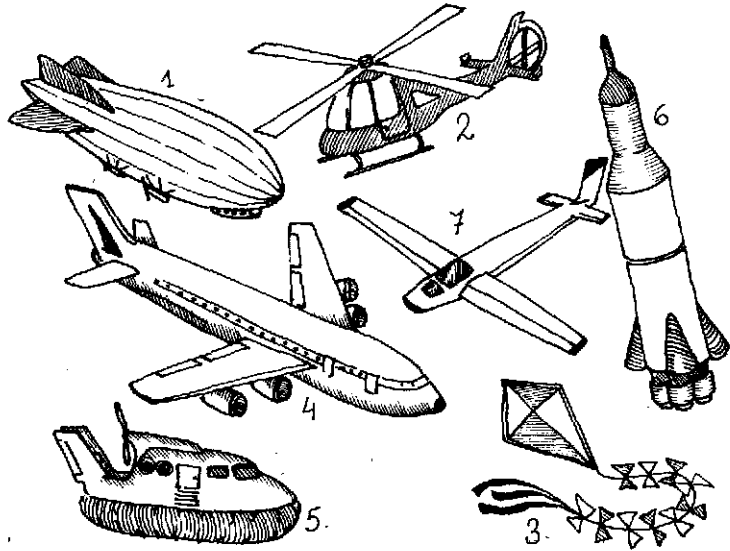

- | | | | |
|----------------|-------------|---------------|----------------|
| ... airliner | ... airship | ... glider | ... helicopter |
| ... hovercraft | ... kite | ... spaceship | |

2. AIR TRAVEL. Choose the correct answer.

- The plane circled over the airport until the was clear.
a) highway b) landing c) runway d) terminal
- All flights in and out of the airport came to a because of the strike.
a) closure b) conclusion c) standstill d) stoppage
- If you carry too much luggage, the airline will charge an baggage fee.
a) additional b) excess c) extra d) over
- British Airways the departure of Flight 222 to Warsaw.
a) advertise b) advise c) announce d) notice
- When you get to the airport, your luggage will have to be
a) balanced b) estimated c) sealed d) weighed
- Because of the fog, our flight was from Heathrow to York Airport.
a) deflected b) diverted c) replaced d) reverted
- The check time at the airport was eight o'clock.
a) by b) in c) out d) up
- The from the airport was very tiring as we had to drive through the fog.
a) crossing b) flight c) ride d) voyage
- It's very strange but I had a(n) that the plane would crash.
a) intuition b) omen c) prediction d) premonition

10. It takes a while to to your surroundings after a long flight.
a) adjust b) balance c) fit d) settle
11. Much stricter must now be taken at all airports against hijacking.
a) alarms b) precautions c) protections d) warnings
12. The air hostess told the passengers to their seat belts.
a) attach b) fasten c) fix d) tie
13. To fly big passenger airliners long training and experience.
a) calls for b) orders c) picks up d) requisitions
14. The plane was towards the runway when the fire started.
a) heading b) landing c) sailing d) soaring
15. The from Warsaw to New York takes nine hours.
a) flying b) journey c) passage d) voyage
16. I'm afraid your luggage is ten kilos ; you will have to pay extra.
a) above b) excess c) heavy d) overweight
17. A passenger is not allowed to a lethal weapon when flying by a civilian airliner.
a) be having b) be owning c) carry d) control
18. Nobody that aeroplane crash.
a) died b) lived c) recovered d) survived
19. Our was delayed owing to bad weather conditions.
a) airline b) airway c) flight d) runway
20. When our flight was delayed, we all had a meal at the airline's
a) account b) cost c) expense d) finance
21. Please, from smoking until the plane is airborne.
a) exclude b) refrain c) restrain d) resist
22. We to announce a further delay in the departure of flight BE-555.
a) apologise b) mourn c) regret d) repent
23. Tickets booked on this flight are not
a) assignable b) moveable c) passable d) transferrable
24. If you want a cheap air ticket you must well in advance.
a) book b) buy c) engage d) reserve
25. He couldn't his fear of flying.
a) overcome b) succeed c) triumph d) win
26. The stewardess the screaming child.
a) corrected b) cured c) recovered d) soothed
27. It was a great to go up in a helicopter for the first time.
a) incident b) rise c) suspense d) thrill
28. Nothing could me to fly except in a case of extreme emergency.
a) encourage b) induce c) influence d) recommend

3. AIR TRAVEL. Answer the clues. The number of letters is given.

- | | | | |
|---|-------|-------|---------|
| | 1 | A | _____ |
| | 2 | _____ | l _____ |
| 3 | _____ | R | _____ |
| | 4 | _____ | - _____ |
| | 5 | _____ | T _____ |
| 6 | _____ | R | _____ |
| | 7 | A | _____ |
| | 8 | V | _____ |
| | 9 | E | _____ |
| | 10 | L | _____ |

1. an area of land where aircraft can land and take off, be kept, repaired, etc. (7)
2. a trip by aeroplane, especially carrying passengers on a regular service (6)
3. a member of the cabin staff who looks after the passengers' needs (7)
4. the act of leaving the ground by an aeroplane (7)
5. a person who flies an aeroplane; captain (5)
6. a big building where planes are kept (6)
7. the act of coming down onto the ground again from the air (7)
8. the science or practice of flying (8)
9. all the people working on an aeroplane (4)
10. a plane without an engine (6)

** 4. PARTS OF THE AIRCRAFT. Match the indicated parts of the aircraft with their names.

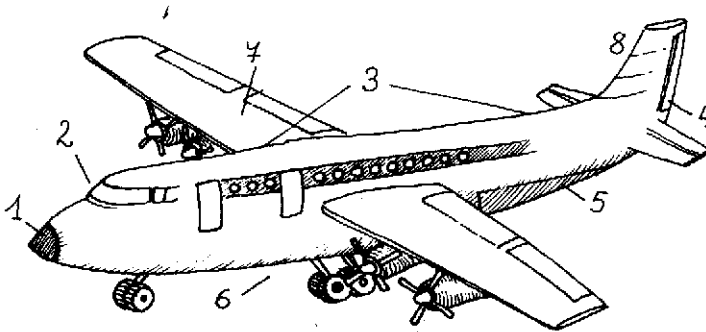

- | | | | |
|-------------|------------|-------------------|-----------|
| ... cockpit | ... fin | ... fuselage | ... hatch |
| ... nose | ... rudder | ... undercarriage | ... wing |

5. AIR TRAVEL. Put each of the following words or phrases into its correct place in the passage below.

air vents	cabin	captain	carry
co-pilot	crew	cruising speed	distances
flight	flight engineer	galley	jet-propelled
passenger	passenger list	safety belts	seats
size	tourist	stewardesses	take-off
trip			

Airliner

Airliners, or planes, differ from light planes not only in but also in speed and equipment. They are designed to a greater number of people over longer without stopping to refuel.

A passenger airliner has a comfortable with soft carpets, adjustable upholstered, washrooms, and individual and reading lights. It has a for preparing food. Many airlines offer, or economy class service, which costs less than first-class travel.

The of four-engine airliners range from about 350 mph for propeller-driven planes to more than 500 mph for planes.

The of an airliner works as a team to make the trip smooth and pleasant. While the passengers take their seats, the pilot or, co-pilot, flight engineer, and stewardesses prepare the plane for The pilot, assisted by the, checks the instruments and tests the controls. The checks the other mechanical equipment. The stewardesses check the, make sure that the passengers fasten their for Later, the distribute magazines, serve meals, and do other things to make the enjoyable.

II. Animals



“Mother”, asked Kate, “is it correct to say ‘water a horse’ when he is thirsty?”

“Yes, dear, quite correct.”

“Then, I am going to milk the cat.”

*

“Talking of ants”, said the American storyteller, “we’ve got them as big as crabs out West.”

“They don’t compare with the ants I saw in the Far East,” said another traveller. “The natives have trained them as beasts of burden. One of them could carry a ton for miles with ease. They worked willingly, but occasionally they turned on their attendants and killed them.”

But this was stretching credulity a bit too far.

“I say,” said one of the listeners, unbelieving, “what sort of ants are they?”

“Eleph-ants,” replied the traveller.

**** 6. ANIMALS. Which is the odd man out?**

1. Which of these is not a mammal?
a) bat b) snail c) whale d) wild pig
2. Which of these is not a rodent?
a) hedgehog b) mouse c) rat d) squirrel
3. Which of these is not an insect?
a) cockroach b) flea c) moth d) shrimp
4. Which of these is not a reptile?
a) alligator b) frog c) lizard d) turtle
5. Which of these is not a bird?
a) sparrow b) spider c) stork d) swan
6. Which of these has spots rather than stripes?
a) leopard b) skunk c) tiger d) zebra
7. Which of these hasn't got horns?
a) bull b) camel c) deer d) elk
8. Which of these doesn't sting?
a) ant b) bee c) butterfly d) scorpion
9. Which of these cannot fly?
a) hawk b) ostrich c) pigeon d) swallow
10. Which of these is not a cat?
a) jaguar b) leopard c) puma d) squirrel
11. Which of these is not a shellfish?
a) lobster b) plaice c) prawn d) shrimp
12. Which of these is not a pedigree domestic dog?
a) collie b) greyhound c) mongrel d) poodle
13. Which of these has most legs?
a) beetle b) centipede c) snake d) spider
14. Which of these is not a fresh-water fish?
a) carp b) herring c) salmon d) trout
15. Which of these is not a mythical creature?
a) dragon b) mermaid c) octopus d) unicorn

**** 7. GENDER OF ANIMALS. Give the feminine or masculine, as required, of the following animals.**

- | | | | |
|----------|---------------|--------------|-----------------------------|
| 1. bull | _____ | 6. hen | _____ c ____; _____ o _____ |
| 2. dog | _____ c ____ | 7. lion | _____ s |
| 3. duck | _____ e | 8. ram | _____ e |
| 4. fox | _____ n | 9. stag | _____ d |
| 5. goose | _____ d _____ | 10. stallion | _____ e |

**** 8. BIRDS.** Match the bird with its description.

- | | |
|----------------|--|
| 1. canary | a. is yellow and sings in a cage |
| 2. cuckoo | b. the most celebrated song bird |
| 3. eagle | c. has a magnificent tail |
| 4. gull | d. a wise bird with big eyes |
| 5. lark | e. sings high in the sky |
| 6. magpie | f. haunts seas and big rivers |
| 7. nightingale | g. can carry messages |
| 8. ostrich | h. lays eggs in other birds' nests |
| 9. owl | i. white with red beak and legs, delivers babies |
| 10. peacock | j. cannot fly |
| 11. pigeon | k. a black and white thief |
| 12. stork | l. a white one is the symbol of Poland |

**** 9. ANIMALS.** Choose the correct answer.

- of cattle graze fertile plains.
a) flocks b) herds c) packs d) swarms
- Cattle and chicken are animals.
a) domesticated b) farm c) tame d) wild
- The tiger had very sharp
a) claws b) fangs c) hooves d) paws
- The lioness lay in wait for her
a) game b) prey c) target d) victim
- When he was exploring the forest, he was bitten by a
a) frog b) rabbit c) snake d) worm
- High in the sky a of birds was flying southward.
a) collection b) company c) flock d) swarm
- The horses have returned to their after the morning exercise.
a) barns b) kennels c) sheds d) stables
- The magpie pecked hard at the ground with its to get at the worms.
a) beak b) fangs c) lips d) mouth
- A great of bees settled on our apple tree during a storm.
a) buzz b) crowd c) flock d) swarm
- The blue, yellow and green of the bird's splendid winter stood out against the background of snow.
a) coat b) dress c) feather d) plumage
- Most animals in captivity have to be fed and at least twice a day.
a) drowned b) drunk c) liquidated d) watered
- Be careful! There's a wasps' nest. Don't it.
a) blast b) disturb c) interfere d) thrill

13. The zoo attendant opened the cage and tried to the animal back in.
a) coax b) convince c) induce d) seduce
14. The deer in the National Park are so accustomed to being fed by visitors that they are quite
a) domestic b) passive c) tame d) trained
15. Most birds are more brilliantly coloured than their wives.
a) husband b) male c) masculine d) master
16. Many people think it is wrong to put animals behind
a) bars b) poles c) rails d) wires
17. The noise of my footsteps the deer and it ran away.
a) amazed b) paralyzed c) shocked d) startled
18. Wild ducks always fly in a "V"
a) figure b) formation c) formula d) shape
19. You will not find kangaroos anywhere else on but in Australia.
a) earth b) ground c) soil d) world
20. Children easily learn to distinguish elephants from other animals because of their long
a) beaks b) nozzles c) snouts d) trunks
21. The ant is a very industrious
a) animal b) beast c) creation d) insect
22. A horse gets rid of by flicking its tail.
a) ants b) butterflies c) flies d) spiders
23. Visitors to the zoo are asked not to the lions.
a) bite b) fret c) nag d) tease

**** 10. YOUNG ANIMALS.** For each animal below give the name of its young from the following list. Some names can be used more than once and in some cases there is more than one answer.

calf	chick	chicken	colt	cub	
duckling	fawn	filly	foal	gosling	
kid	kitten	lamb	nestling	piglet	puppy

- | | |
|---------------------|-----------|
| 1. bird | 2. cat |
| 3. cow | 4. deer |
| 5. dog | 6. duck |
| 7. elephant | 8. fox |
| 9. goat | 10. hen |
| 11. horse | 12. lion |
| a. (newborn) | |
| b. (young stallion) | |
| c. (young mare) | |
| 13. pig | 14. sheep |
| 15. wolf | |

11. ANIMALS. *Choose the best answer.*

1. The horse hurt one of its in the race.
a) claws b) heels c) hooves d) paws
2. A of sheep crossed in front of our car and blocked the road.
a) bunch b) crowd c) flock d) pack
3. The wild animal savagely at the piece of meat.
a) eat b) severed c) split d) tore
4. Modern farm animals are the result of centuries of selective
a) breeding b) cultivation c) mating d) reproduction
5. The koala bear's consists almost entirely of eucalyptus leaves and shoots.
a) diet b) digestion c) nourishment d) nutrition
6. He was by a bee when he went too close to the hive.
a) bitten b) pricked c) stung d) torn
7. A leopard has spots and a tiger has
a) bands b) streaks c) stripes d) strips
8. A good hen six or seven eggs a week.
a) lays b) lies c) places d) reproduces
9. The children went to the zoo and saw the monkeys in their
a) boxes b) cages c) dens d) pits
10. One of the tigers has got Warn everyone of the danger!
a) escaped b) loose c) loosened d) lost
11. The elephant fell into the the hunters had set for it.
a) trail b) trap c) trick d) trip

**** 12. ANIMAL HABITAT.** *Choose the correct names of the places where the following animals live or are kept. In some cases there is more than one answer.*

- | | | | |
|--------------------|-------------|--------------|-----------|
| 1. ants | a) ant-hill | b) ant-heap | c) coop |
| 2. beavers | a) dam | b) lair | c) lodge |
| 3. bees | a) coop | b) hive | c) hutch |
| 4. birds | a) aviary | b) kennel | c) nest |
| 5. captive animals | a) cage | b) menagerie | c) zoo |
| 6. pet fish | a) aquarium | b) coop | c) warren |
| 7. cows | a) barn | b) kennel | c) shed |
| 8. dogs | a) hive | b) coop | c) kennel |
| 9. foxes | a) earth | b) kennel | c) lair |
| 10. hens | a) coop | b) run | c) shed |
| 11. horses | a) den | b) paddock | c) stable |
| 12. lions | a) den | b) lair | c) warren |
| 13. pigs | a) aviary | b) kennel | c) sty |
| 14. rabbits | a) den | b) hutch | c) warren |
| 15. wasps | a) hive | b) hutch | c) nest |

* 13. ANIMALS. Choose the correct answer.

1. A number of gulls were effortlessly high above the cliffs.
a) coasting b) floating c) gliding d) soaring
2. Crocodiles and alligators are
a) crustaceans b) herbivores c) mammals d) reptiles
3. Only after buying the cottage did we discover that it was with mice.
a) infected b) infested c) inflicted d) invaded
4. The sheep were herded into a to protect them from stray dogs.
a) cage b) hutch c) kennel d) fold
5. I'm sure there are spiders in your room; look at those in the corner.
a) cobwebs b) nets c) meshes d) networks
6. The animals taken to the slaughterhouse must be killed by methods.
a) human b) humane c) humanistic d) humble
7. On the beach the crabs from rock pool to rock pool.
a) scuttled b) shuffled c) stole d) strutted
8. A hatches from an egg laid by a butterfly or moth.
a) caterpillar b) maggot c) toad d) worm
9. I'll that mosquito if it settles on my arm.
a) slap b) smack c) stab d) swat
10. There is an old horse over there, where animals could drink on the way to market.
a) gutter b) moat c) trench d) trough
11. Crows and vultures are living on carrion.
a) amphibians b) predators c) parasites d) scavengers
12. The frightened horse began to away from the snake.
a) fear b) shy c) throw d) tip
13. Wolves were mournfully in the nearby forest.
a) barking b) growling c) howling d) roaring
14. Rabbits and mice are
a) amphibians b) carnivores c) reptiles d) rodents
15. We could hear the hens in the farmyard.
a) chattering b) chirping c) clacking d) clucking
16. When it saw the dog by the water, the heron its wings and rose into the air.
a) flapped b) flipped c) folded d) wagged
17. Look at the marks on the cherries where the birds have them!
a) bitten b) gnawed c) nibbled d) pecked
18. As he walked through the fields, he heard sheep
a) bleating b) braying c) roaring d) shrieking
19. The snake smoothly through the long grass.
a) crept b) glided c) skidded d) strolled
20. The bird had its nest on a halfway down the cliff.
a) bump b) ledge c) shelf d) sill

21. Many insects, such as wasps and ants, use their to touch objects.
a) aerials b) antennae c) ears d) horns
22. A donkey loudly all through the night.
a) brayed b) cackled c) neighed d) roared
23. Look at the seagulls up and down on the waves near the fishing boats.
a) bobbing b) bouncing c) hopping d) jerking
24. Swallows cannot take off from the ground like most birds. They use wind currents to through the air.
a) beat b) flap c) glide d) skid
25. The terrified hunter, in the arms of a huge bear, fought desperately to loosen its grip.
a) clasped b) grasped c) locked d) nestled

*** 14. ANIMAL SOUNDS.** *Match each animal with the sound, or sounds, it makes.*

- | | |
|-------------|----------------------------------|
| 1. bee | a) barks; growls; snarls; whines |
| 2. cat | b) bleats; baas |
| 3. cock | c) brays; hee-haws |
| 4. cow | d) buzzes |
| 5. cricket | e) chirps |
| 6. dog | f) clucks |
| 7. donkey | g) croaks |
| 8. duck | h) crows |
| 9. elephant | i) hisses |
| 10. frog | j) hoots |
| 11. hen | k) howls |
| 12. horse | l) grunts; squeals |
| 13. lion | m) miaows; purrs |
| 14. mouse | n) moos |
| 15. owl | o) neighs; whinnies |
| 16. pig | p) quacks |
| 17. sheep | r) roars |
| 18. snake | s) squeaks |
| 19. wolf | t) trumpets |
| 20. bird | u) twitters; chirps; sings |

15. ANIMAL COATS. *What are the following animals covered with? Fill in the grid.*

	FEATHERS	FUR	HIDE	SCALES	SHELL	SKIN	WOOL
beaver							
crocodile							
eagle							
cat							
cow							
elephant							
frog							
llama							
lobster							
monkey							
oyster							
parrot							
pig							
pike							
stork							
tiger							
turtle							

**** 16. COLLECTIVE NOUNS.** *Match the names for the groups of animals with the animals on the right. In some cases there is more than one possible match.*

- | | | |
|------------|----|--------------------|
| | | ants |
| | | bees |
| 1. brood | | birds |
| 2. colony | | cattle |
| 3. flight | | deer |
| 4. flock | | dogs |
| 5. gaggle | | fish |
| 6. herd | | geese |
| 7. litter | | hounds for hunting |
| 8. pack | of | lions |
| 9. pride | | monkeys |
| 10. shoal | | oxen for ploughing |
| 11. school | | puppies; pups |
| 12. swarm | | sheep |
| 13. team | | whales |
| 14. troop | | wolves |
| | | young chickens |

17. PETS. *Choose the right answer.*

1. He stroked his cat's silky fur and the cat contentedly.
a) growled b) hummed c) purred d) roared
2. This of dog is very useful for hunting.
a) breed b) clan c) stock d) tribe
3. A cat its paw before it washes its face.
a) bites b) chews c) laps d) licks
4. It's dangerous to go near that building site as it is by a fierce dog.
a) defended b) guarded c) resisted d) restricted
5. Don't take any of that dog. It is only playing.
a) care b) game c) notice d) part
6. My dog always when it sees the postman.
a) barks b) cries c) purrs d) spits
7. The noise was caused by a dog a cat through the garden.
a) catching b) chasing c) fighting d) running
8. If your cat often has to stay indoors, then a tray must be provided.
a) garbage b) litter c) rubbish d) waste
9. You should take notice of warnings which state that guard dogs are on
10. The dog felt very when his owners left the house, dressed for a walk.
a) alert b) defence c) patrol d) watch
11. The dog felt very when his owners left the house, dressed for a walk.
a) cheated b) deceived c) deceptive d) disappointed
12. In big cities animals should be kept under
13. The poor cat was at the top of the tree.
a) authority b) check c) control d) discipline
14. The poor cat was at the top of the tree.
a) bent b) climbed c) fixed d) stuck
15. Don't touch the cat, he may you.
a) kick b) scratch c) scream d) tear
16. Dogs have a habit of bones in the garden.
a) burying b) covering c) digging d) planting
17. Both kindness and firmness are needed to domestic animals successfully.
a) educate b) practice c) train d) tutor
18. It is difficult to a dog, if you live in a flat.
a) have b) hold c) keep d) take
19. A dog can be a very pleasant on long country walks.
a) companion b) company c) fellow d) friend
20. They put the bird in a cage to it flying away.
a) avoid b) hinder c) let d) stop
21. A cat purrs when it is pleased, but a dog its tail.
a) bends b) moves c) wags d) waves
22. I was badly scratched by my cat's
23. I was badly scratched by my cat's
a) claws b) hooves c) nails d) paws
24. When my wife comes home, our dog always jumps up and her face.
a) kisses b) licks c) moistens d) sucks

22. When the cat is angry, its stands up on end.
 a) feather b) fur c) hide d) skin
23. His dog has done everything he told it to do; it is a most animal.
 a) acceptable b) commanding c) obedient d) orderly
24. Dogs in city streets should be kept on a
 a) cord b) lead c) rope d) string

*** 18. PETS.** *Choose the best answer.*

1. The dogs in the circus were trained to walk on their legs.
 a) base b) hind c) rear d) tail
2. The trouble with cats and dogs is that their hair comes out in the spring when they
 a) cast b) moult c) peel d) shed
3. As the cat lay asleep, dreaming, his whiskers
 a) jerked b) jogged c) tweaked d) twitched
4. He had taught his dog to the rabbits he shot.
 a) recover b) regain c) restore d) retrieve
5. Even a small dog in a house can a thief.
 a) arrest b) counter c) deter d) forestall
6. Much is done in our city to the suffering of unwanted domestic pets.
 a) alleviate b) help c) improve d) remedy
7. The dog let out a of pain when his tail was trodden on.
 a) bark b) croak c) squawk d) yelp
8. The dog up his ears when he heard his master's voice.
 a) lifted b) pointed c) pricked d) raised
9. To keep a dog's in good condition, it should be brushed daily.
 a) coat b) fleece c) fur d) hide
10. The dog's ears as he heard footsteps outside the house.
 a) trembled b) twitched c) wagged d) wriggled

19. ANIMALS. *Choose the word that best keeps the meaning of the original sentence if it is substituted for the capitalized word or phrase.*

1. The dog **GNAWED** the bone before he buried it.
 a) chewed
 b) kicked
 c) licked
 d) trampled

2. Male lions remain ALOOF FROM the day-to-day activities of their families.
 - a) bored with
 - b) exhausted from
 - c) separate from
 - d) upwind of
3. The grasshopper is an insect that can LEAP about twenty times the length of its own body.
 - a) call
 - b) hear
 - c) jump
 - d) see
4. Chalk deposits are formed chiefly from the shells of MINUTE sea animals called foraminifera.
 - a) dried-up
 - b) minor
 - c) minuscule
 - d) short-lived
5. The habitat of an animal should be large enough to yield a COPIOUS supply of food.
 - a) an elaborate
 - b) an indefinite
 - c) a plentiful
 - d) a solid
6. Although they usually prey on small mammals and birds, eagles have also been known to BAND TOGETHER and attack large animals.
 - a) devise nests
 - b) form groups
 - c) sing harmoniously
 - d) swoop down
7. When the hedgehog feels threatened, it tucks its head into its chest and rolls itself into a SPINY, ball-shaped mass.
 - a) bushy
 - b) motionless
 - c) prickly
 - d) spherical
8. Monkeys are sometimes described as CURIOUS animals.
 - a) careful
 - b) clever
 - c) inquisitive
 - d) resourceful
9. The most important environmental influence on fish is water temperature, for fish tend to TAKE ON the temperature of their surroundings.
 - a) assume
 - b) avoid
 - c) exceed
 - d) regulate

10. The nests of most finches are constructed **SLOPPILY**.
- annually
 - characteristically*
 - elaborately
 - messily
11. When a flounder first **HATCHES**, it looks like a typical fish.
- emerges from the egg*
 - matures
 - rises from the bottom
 - swims about
12. **Hibernation** is a state of inactivity in which some animals **PASS** the winter.
- miss
 - prepare for
 - spend
 - wait for

**** 20. INSECTS.** Put each of the following words and phrases into its correct place in the passage below.

bee	beetles	butterflies	caterpillars	cobwebs
crickets	fleas	gnat	grasshoppers	maggots
mosquito	moths	pupae	spiders	wasp

Some Insects

A makes honey, but a also black and yellow, does not.
 are more often seen by day and by night — both may develop from and later Clothes moths lay eggs in clothes.
 A bites or stings and can spread malaria; the , very common in Poland, is less dangerous.
 are usually black, with hard wing covers; may have an almost continuous high chirp, heard at night; jump through the grass; jump and bite animals and people; are found in fruit and peas; spin webs, which when dirty are called

21. ANIMAL PROTECTION. Choose the best answer.

- I didn't know that species of fish was still
 a) extant b) extent c) extinct d) extinguished
- Most African countries have now the killing of elephants.
 a) banned b) dismissed c) prevented d) refused
- Animals should not be locked in cages; they should be in their normal
 a) environment b) home c) position d) residence

4. There is a large for rare tropical birds in the National Park.
a) aviary b) cage c) reserve d) zoo
5. Many species of animals today are
a) endangered b) in risk c) risky d) under danger
6. A bird has been established on this island.
a) asylum b) haven c) refuge d) sanctuary
7. Much of our knowledge about prehistoric animals comes from the study of
a) artefacts b) fossils c) relics d) ruins
8. Unless we can prevent people from hunting snow leopards, the species will
a) die out b) drop out c) extinguish d) fall out
9. Unless stricter hunting laws are introduced, seals will soon be
a) archaic b) defunct c) extinct d) obsolete
10. My friend is a keen amateur
a) natural historian b) naturalist c) naturist d) nature-lover

22. ANIMALS. Crossword.

ACROSS:

2. long-winged sea bird
4. an Australian animal that jumps
6. stag or hind
8. the most common insect
9. snake-like fish
11. part of a cat with whiskers or of a bull with horns
12. contains the embryo of birds, reptiles or insects
13. relative of tortoise

DOWN:

1. wife of a cock/rooster
2. animal with dark spots and a very long neck
3. king of the animals
4. young goat
5. large ape closely related to man
7. animal with a trunk
10. king of the birds

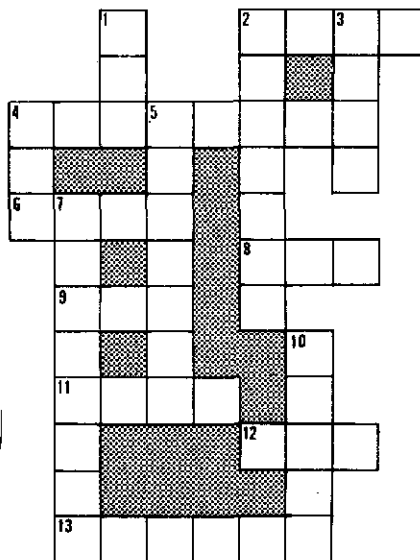

III. The Army

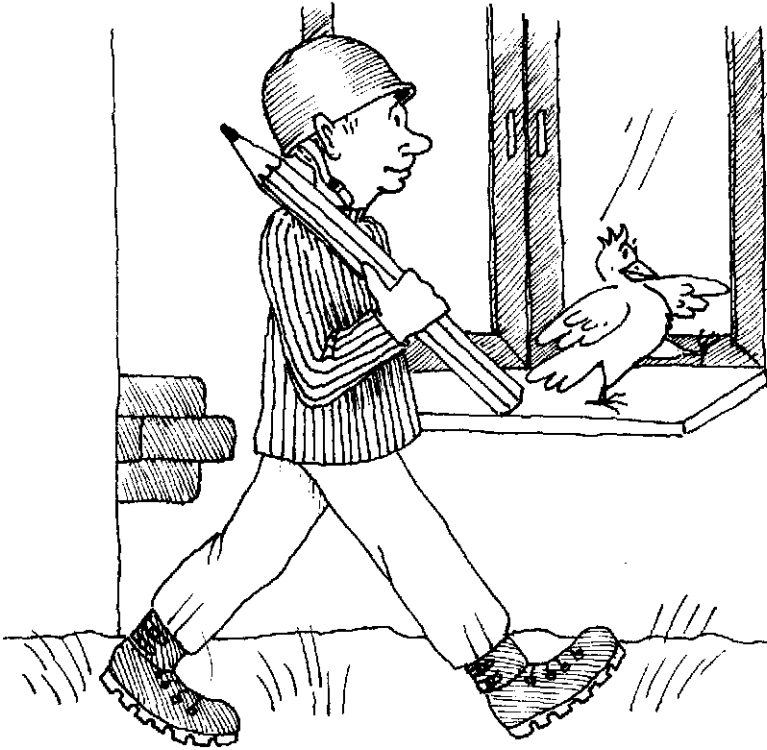

Artillery Commander: "Fire at will!"

Recruit: "Where's Will?"

*

The division commander received a report by radio from one of his unit commanders.

"Sir, we are trapped — surrounded by enemy tanks."

"That's not correct," said the general. "Your force is not surrounded. You are just fighting in four different directions."

23. THE ARMY. *Choose the correct answer.*

1. The army defeat at the hands of its enemy.
a) bore b) suffered c) supported d) tolerated
2. The defeated army was obliged to to its second line of defence.
a) back away b) draw away c) retire d) retreat
3. There was a sudden of anger in the General's eyes as he listened to the soldier's report.
a) fire b) flame c) flash d) shade
4. The encouraging news enabled the troops to go on with hope.
a) novel b) recurrent c) renewed d) renovated
5. All the information relating to the enemy officers was alphabetically in large cabinets.
a) composed b) crammed c) filed d) gathered
6. General Brave was placed command of the Western Army.
a) at b) in c) to d) with
7. The soldier his gun at the enemy.
a) banged b) exploded c) fired d) shot
8. Private Daring felt proud when the general said "You a medal!"
a) deserve b) earn c) expect d) reserve
9. The sound of our voices was completely by the roar of the artillery.
a) decreased b) drowned c) reduced d) scattered
10. Schik claimed from military service as he was a foreign national.
a) demobilisation b) exception c) exemption d) liability
11. After two hours of hard fighting, the Northern Army won the
a) attack b) battle c) force d) war
12. The depleted column was barely able to the enemy attack.
a) expel b) smash c) withhold d) withstand
13. The army claimed that during the invasion there was no of life.
a) death b) killing c) loss d) murder
14. The memorial in the main square the soldiers who lost their lives in the war.
a) celebrates b) commemorates c) recalls d) remembers
15. A feeling of tiredness almost the soldier on duty and he had to struggle hard to keep awake.
a) conquered b) defeated c) overcame d) put out

24. THE ARMY. *Choose the correct answer.*

1. Private Courageous a dangerous mission, although he knew he might be killed.
a) agreed b) entered c) promised d) took on
2. There is a bomb in the garden, it could at any moment.
a) bang b) crack c) crash d) explode

3. A sergeant in the army wears three on his arm.
a) scratches b) captions c) medals d) stripes
4. The soldiers had for fifteen hours without stopping and they were exhausted.
a) hiked b) marched c) run d) wandered
5. Betty's fiance, who is a soldier, was delighted when he was only a few miles from her home.
a) camped b) directed c) placed d) stationed
6. After the campaign a special medal was to all combatants.
a) awarded b) deserved c) earned d) gained
7. Corporal Lucky was hit by a bullet but he was only wounded.
a) barely b) little c) merely d) slightly
8. This general always his own troops into battle.
a) commanded b) fought c) led d) pulled
9. The troops were lined up on the parade ground awaiting the general's
a) checking b) inspection c) investigation d) review
10. Sergeant Proud can hardly having to accept orders from the colonel who is much younger than himself.
a) bear b) mind c) resist d) suffer
11. A force of desperate men burst out of the besieged city and the army that had surrounded them.
a) broke down b) defeated c) gained d) won
12. The defending armies achieved a great over the aggressors.
a) conquest b) defeat c) loss d) victory

*** 25. THE ARMY.** Match the definitions with the defined word.

I. MILITARY ACTIVITIES.

- | | |
|---------------|--|
| 1. to inspect | a) to inspect very formally and ceremonially, esp. by an officer of high rank, or a king |
| 2. to muster | |
| 3. to parade | b) to show respect by raising an arm or firing a gun |
| 4. to salute | c) to look at soldiers in order to examine the state of their uniforms, etc. |
| 5. to review | d) to bring soldiers together for a review or parade |
| | e) to march in ceremonial order |

II. ATTACKING

- | | |
|--------------|--|
| 6. ambush | f) taking control of another country |
| 7. assault | g) a brief unimportant fight |
| 8. invasion | h) an attack on a place by keeping an army round it and stopping anyone from getting in or out |
| 9. raid | |
| 10. siege | i) a surprise attack |
| 11. skirmish | j) a sudden secret attack by a small group |
| | k) a strong attack |

III. TAKING AND LOSING

- 12. to annex l) to capture quickly or very forcefully
- 13. to surrender m) to take control over land
- 14. to capture n) to get by fighting
- 15. to liberate o) to stop the siege
- 16. to relieve p) to set free from a tyrant or conqueror
- 17. to seize r) to give oneself up to the enemy

26. THE ARMY. *Put the following words in their correct places in the sentences below. Some words may be used more than once and there may be more than one answer in some sentences.*

campaign casualty ceasefire defeat
losses surrender triumph truce
victory

- 1. They suffered heavy in the last battle.
- 2. If Napoleon's at Austerlitz was the high-point of his military career, his to take Moscow was a failure leading to the at Waterloo which was his end.
- 3. Her son is a of the Vietnam war: he lost both his legs.
- 4. The German unconditional was accepted by the Allied Powers.
- 5. The Norman of Britain began in 1066.
- 6. The commanders agreed on a(n) for a period of five hours to allow the removal of the wounded.

*** 27. THE ARMY.** *Choose the correct answer.*

- 1. I wouldn't advise you to join the army, Sam. I don't think you are to be a soldier.
a) cut out b) made up c) put down d) set down
- 2. The doctor the dying soldier long enough to learn where the enemy was hiding out.
a) alive b) came round c) resuscitated d) reviled
- 3. Since WW II the rivalry in military strength between the great powers has produced a balance of power.
a) devious b) precarious c) present d) previous
- 4. The soldier had to for disobeying orders.
a) hear sentence b) prove innocent c) serve notice d) stand trial
- 5. At the beginning of the war every man under forty was to serve in the armed forces.
a) called for b) called in c) called out d) called up
- 6. The army major was found guilty of serious misconduct and was accordingly to the ranks.
a) demoted b) elevated c) promoted d) reduced
- 7. The leaders, sensing that war was, prepared their defences.
a) immediate b) immense c) imminent d) immune

8. Unsuitable recruits should be before they start training.
a) laid aside b) narrowed down c) passed over d) weeded out
9. When you fire, keep calm and just squeeze the gently.
a) barrel b) rifle c) sight d) trigger
10. All members of the armed forces are required to allegiance to the president.
a) announce b) certify c) confess d) swear
11. The tank of petrol was by a carelessly discarded cigarette end.
a) exploded b) ignited c) inflamed d) lit up
12. Oswald was for military service because he had flat feet.
a) discarded b) discharged c) dispensed d) rejected
13. The of the soldiers was high before the battle, because they were confident of victory.
a) mood b) moral c) morale d) temper
14. Our plan is completely Nothing can possibly go wrong.
a) airtight b) foolhardy c) foolproof d) waterproof
15. The officer sent a man ahead to the land, suspecting that the enemy were near.
a) enquire b) investigate c) reconnoitre d) spy

**** 28. THE ARMY.** Put each of the following words or phrases into its correct place in the passage below.

administrative duties	army post	assignment	barracks
company-sized unit	cooks	dayroom	drill
guard duty	marching	mess hall	perimeter
recreation	reveille	reviews	
roll call	soldier	soldiers	
supervises	supply sergeant	training	
troops	unit commander	weapons	

A Typical Day in the Army

A typical day for a depends on his During peacetime at a permanent , the bugler sounds at 5:30 or 6 a.m. to waken the After , the men wash and shave, go to the for breakfast.

Next they form ranks for They practice various routines and the use and care of Other men take care of housekeeping details. The begin their work long before reveille. The first sergeant and company clerk handle the and "paperwork" of the unit. The mess sergeant the cooks. The cares for and issues clothing and equipment. Each Saturday, the inspects the entire company.

Drill is usually completed by 11 a.m. After dinner at noon, the men return to their jobs or All day and night some officers and men are on They are posted at warehouses, motor pools, storage depots and around the

Parades and sometimes take place in the afternoon until about 5 p.m. After

supper, not assigned special duties may do as they please. Most army posts have buildings called service clubs. Each has a clubroom called a Men who do not have permission to stay out must be in their by 11 p.m. and lights must be turned off.

**** 29. WEAPONS AND EQUIPMENT.** *Divide the following into three groups: weapons, ships, aircraft.*

aircraft carriers	bazookas	bombers	
destroyers	fighters	guided missiles	cruisers
howitzers	machine guns	minesweepers	helicopters
rifles	submarines	tugs	mortars

*** 30. THE ARMY.** *Put each of the following words or phrases in their correct place in the passage below.*

artillery	bazookas	close combat	combat arms
defend	direct fighting	enemy forces	foot
grenades	guns	infantry	infantrymen
parachute	personnel carriers	seize	soldiers
units			

The Infantry

Combat units of the army consist of trained and equipped to fight Infantry, , and armoured units are called the combat arms, because they do the Other of the army, called the services, support and serve the

The is the army's largest arm. Infantrymen must , occupy and land areas. (They bear the heaviest share of

. . . . throw and fire rifles, machine , mortars, and pistols.

They enter battle on , by helicopter, , or in armoured

**** 31. MILITARY COMMANDS.** *Match the Polish counterparts of the following English military commands.*

- | | |
|-------------------|-----------------------|
| 1. About turn! | a) Baczość! |
| 2. At ease! | b) Na prawo patrz! |
| 3. Attention! | c) Naprzód marsz! |
| 4. Eyes right! | d) Rozkaz! |
| 5. Fall in! | e) Rozejść się! |
| 6. Fall out! | f) Spocznij! |
| 7. Forward march! | g) Stój! |
| 8. Halt! | h) W prawo zwrot! |
| 9. Line up! | i) Wystąp! |
| 10. Right turn! | j) W tył zwrot! |
| 11. Step out! | k) W szeregu zbiórka! |
| 12. Yes, sir! | l) Zbiórka! |

32. THE ARMY. *Complete.*

1. Our patrol met a group of (żołnierze wroga) Two of them were (zraniony) and were taken (jeniec)
2. Last night ten enemy (bombowce) raided our (granica) areas and bombed a power plant.
3. All the men in Jerry's family are in the army; his father is a (pułkownik) , his brother is a (sierżant) , but he himself is only a (szeregowy)
4. Although his father wants him to go into the (wojska lądowe) Andy would rather enlist in the (lotnictwo) or in the (marynarka)
5. "The proud, the few, the (żołnierze piechoty morskiej)"

IV. Clothing

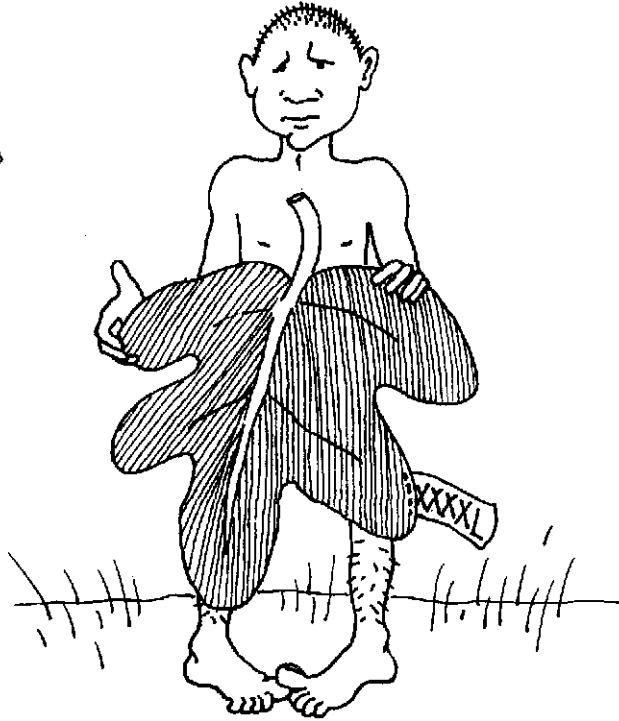

Tom: "What would you do if you were in my shoes?"

Tim: "I would polish them."

*

She ranted and raved. She complained and pleaded. She cried and threatened.

"You'd think I treated you like a dog," her husband retorted.

"No!" she screamed. "A dog has a fur coat!"

33. ITEMS OF CLOTHING. Give the name of each of the indicated items of clothing.

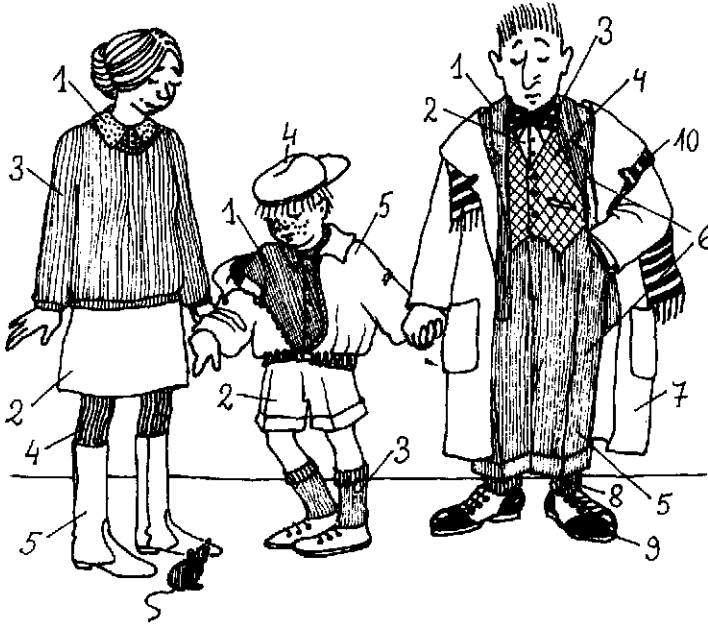

34. PARTS OF CLOTHING. Match each of the following parts of clothing with the correct number in the pictures below.

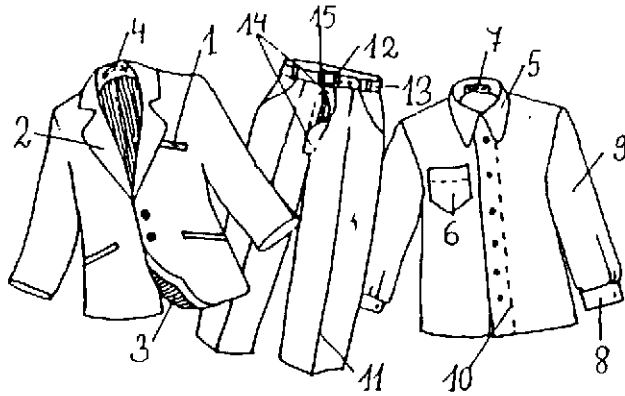

- | | | |
|-----------------|-------------------|------------|
| ... belt | ... breast pocket | ... buckle |
| ... button-hole | ... collar | ... crease |
| ... cuff | ... fly | ... label |
| ... lapel | ... lining | ... loop |
| ... seam | ... sleeve | ... zip |

35. CLOTHING. Choose the correct answer.

1. The boxer in the dark is sure to win. He's much better than the other one.
a) costume b) pants c) trousers d) trunks
2. Why don't you wear a(n) when you do the washing-up?
a) apron b) cloth c) duster d) towel
3. Mary was wearing a very skirt which swirled round her as she danced.
a) big b) full c) loose d) tight
4. My brother is always wearing the same shirt.
a) lined b) spotted c) striped d) tie
5. The tailor made Joe a new
a) clothes b) dress c) suit d) wear
6. Ann looked very severe in a black dress with white collar and
a) bottoms b) cuffs c) ends d) hands
7. The most expensive coats are made of mink.
a) feather b) fur c) hair d) skin
8. Mr Smith arrived wearing a suit, but he put on his before going into the workshop.
a) overalls b) overcoat c) overwork d) underclothes
9. He turned up his to protect his neck from the cold wind.
a) cap b) collar c) scarf d) sleeve
10. After joining the tennis club, Pete started wearing a smart with a badge on the pocket.
a) blazer b) cardigan c) tunic d) waistcoat

11. It's a smart restaurant and men have to wear a
a) blouse b) coat c) dress d) jacket
12. She bought a new for the birthday party.
a) cloth b) dress c) vest d) wear
13. My father always wears a blue silk handkerchief in his pocket.
a) breast b) chest c) shoulder d) heart
14. Hearing a knock at the front door, the woman threw a(n) over her pyjamas and went downstairs to open the door.
a) bra b) dressing-gown c) evening dress d) nightdress
15. He was wearing a dark green tie over his cream
a) blouse b) jacket c) scarf d) shirt

36. CLOTHING. *Choose the right answer.*

1. Lisa was wearing a pure white dress, with a gold belt round her
a) bust b) hips c) knees d) waist
2. Look at those holes in my fur! I am afraid the have been at it.
a) butterflies b) insects c) moths d) worms
3. That dress isn't really tight. It'll when you wear it.
a) bend b) expand c) squeeze d) stretch
4. The suit was badly made and didn't him properly.
a) fit b) frame c) meet d) round
5. To say that all Polish Americans wear brightly coloured clothes is a generalisation.
a) brushing b) complete c) sweeping d) thorough
6. Excuse me, but I think you've got your pullover on
a) doubled up b) in reverse c) inside out d) upside down
7. The room was in a terrible mess with a of clothes all over the floor.
a) jumble b) huddle c) litter d) mixture
8. That's a nice dress. It you perfectly.
a) costumes b) goes c) matches d) suits
9. Everyone else was so smartly dressed that I felt in my shabby clothes.
a) ashamed b) disgraced c) embarrassed d) happy
10. The girl's dress was the first thing that him to her.
a) attracted b) fetched c) lured d) tempted

37. CLOTHING. *Crossword.*

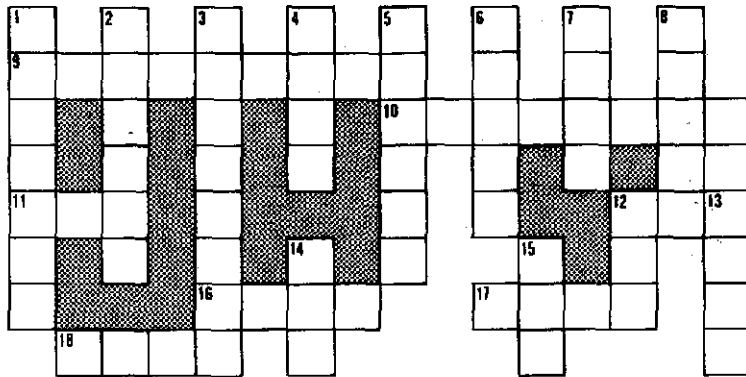

ACROSS:

- 9. sleeveless garment worn under a jacket, also called VEST (U.S.) (9)
- 10. light coat of waterproof material (8)
- 11. band of material worn round the neck and knotted in front (3)
- 12. part of trousers or briefs (3)
- 16. protected by a collar or scarf (4)
- 17. use as clothing (4)
- 18. wedding or diamond (4)

DOWN:

- 1. woolly garment worn for warmth (7)
- 2. precious metal (6)
- 3. tight-fitting covering of e.g. nylon or silk for the foot and leg (8)
- 4. part of a shoe (4)
- 5. part of a pattern (3)
- 6. not a blouse (5)
- 7. short stocking (4)
- 8. piece of material worn about the shoulders or head (5)
- 12. expensive coat (3)
- 13. slightly less than a metre (4)
- 14. very cold (3)
- 15. protected by tights (3)

38. ELEGANCE. *Choose the correct answer.*

- 1. That's a very suit you are wearing. Is it a new one?
a) proper b) smart c) tasty d) well-dressed
- 2. I'm the only one at this party in a long dress — I feel quite out of
a) order b) place c) practice d) turn
- 3. Long dresses are in again.
a) craze b) form c) mode d) fashion

4. He couldn't find two that matched, so he was forced to wear socks.
a) mixed b) odd c) uneven d) unlike
5. It is a good idea to be dressed when you go for an interview.
a) boldly b) clearly c) finely d) smartly
6. It was not a grand occasion, so we were asked to wear clothes.
a) cheap b) informal c) simple d) unofficial
7. My wife has excellent in clothes.
a) choice b) flavour c) gusto d) taste
8. I'm afraid those clothes are not at all for the occasion.
a) fitted b) matching c) suitable d) suiting
9. I must get a new suit, because this one is completely
a) finished b) run out c) used up d) worn out
10. Those new dresses may be striking but that sort of does not suit everyone.
a) fashion b) form c) model d) mood
11. Wearing odd socks would be classed as behaviour.
a) eccentric b) ecstatic c) erotic d) exotic
12. She studies many magazines and books about fashion, entertaining and social behaviour as she wants to appear
a) elegant b) fashionable c) polished d) sophisticated
13. My friend came to the party wearing a shabby old suit, worn-out shoes and no socks. He looked just like a
a) criminal b) merchant c) prisoner d) tramp
14. When I was invited to a-dress party last week, I went as an angel and I wore a beautiful two-winged costume.
a) fancy b) funny c) historical d) masquerade

39. CLOTHING. *Decide whether the following clothes are usually worn above the waist, below it, or both, and whether they are worn usually by women or men, or both.*

	above	below	both	women	men	both
blazer						
nightdress						
skullcap						
slip						
suit						
tights						
top hat						
turtleneck						
underwear						

40. CLOTH OR MATERIAL? Complete each of the following sentences with one of the words below.

cloth clothe clothes clothing cloths
 dress dresses dressing dressings material

1. He never changes his — his shirt and trousers are filthy.
2. A shirt or a sock are articles of
3. The two Mary bought yesterday are very beautiful.
 And they both match her new hat, too.
4. As he had seven sons he had to work hard to his big family.
5. Where have you put the two dish-..... I left in the sink?
6. I'm afraid you have bought too much for just one overcoat.
7. We had to tear a new bed sheet to make a for the wound.
8. In the mountain region you still often see people wearing their national
9. In the past, people used to wear just a piece of wrapped round the body.
10. My favourite salad are French and Italian.

41. KINDS OF MATERIAL. Name the pattern on the following materials.



1. _ _ _ r _ _ _ _ _
2. _ _ _ _ _ t _ _ _
3. _ _ _ _ _ c _ _ _ _ _
4. _ _ _ _ _ i _ _ _

42. KINDS OF MATERIAL. Material can be striped in various ways: vertically, horizontally, diagonally. Match.

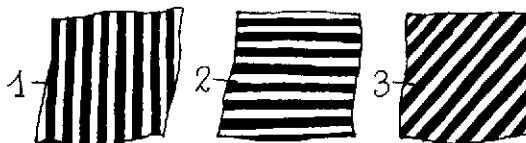

1.
2.
3.

43. KINDS OF MATERIAL. Match the following names of materials with their definitions on the right.

- | | |
|-------------|--|
| 1. corduroy | a. cloth made of flax, used especially |
| 2. cotton | for making shirts, bed-sheets, tablecloths |
| 3. denim | b. cloth made from soft hair of sheep, |
| 4. flannel | used for making sweaters |
| 5. lace | c. thread spun from a soft white fibrous |
| 6. leather | substance found round the seeds of a plant: |
| 7. linen | used for making shirts, underwear, etc. |
| 8. nylon | d. material made from the soft thread from |
| 9. silk | the cocoons of certain insects, used for |
| 10. suede | making scarfs, etc. |
| 11. velvet | e. material made from animal skins, used for |
| 12. wool | making shoes, gloves, bags, etc. |
| | f. kind of soft leather made from the |
| | skin of goats, with the flesh surface |
| | rubbed into a soft nap, used for making |
| | gloves, shoes, etc. |
| | g. synthetic fibre used for making |
| | stockings and blouses |
| | h. cloth with a thick soft nap on one |
| | side, used for making dresses, etc. |
| | i. thick strong cotton material with |
| | raised lines on it; used for making |
| | trousers or suits |
| | j. a delicate fabric of interlacing |
| | threads; used for making wedding dresses, |
| | nightgowns, etc. |
| | k. a soft, nappy, woollen cloth of loose |
| | texture; used for making shirts or trousers |
| | l. a coarse cotton cloth used for jeans |

44. CLOTHING. Choose the correct answer.

- I've bought some very nice and I'm going to make a dress out of it.
a) clothing b) costume c) material d) pattern
- She the material with her fingers, enjoying the smooth silky feeling of its surface.
a) glided b) slid c) slipped d) stroked
- We chose the for a suit and had it made up by our tailor.
a) cloth b) clothes c) clothing d) textile
- Come here! You've got a of cotton on your coat. I'll take it off.
a) cord b) fibre c) string d) thread

5. There was wool everywhere. Her little niece had completely the pullover she had almost finished knitting.
 - a) disentangled
 - b) unfastened
 - c) unravelled
 - d) untied
6. It was a very beautiful cloth of silk.
 - a) composed
 - b) made
 - c) threaded
 - d) worn
7. Pure silk has a all of its own.
 - a) gloss
 - b) light
 - c) polish
 - d) sheen
8. My grandma insists on the woollen socks I wear to play football.
 - a) composing
 - b) dressing
 - c) knitting
 - d) threading
9. The tweed for this suit was in Scotland.
 - a) knitted
 - b) laced
 - c) threaded
 - d) woven

45. **FABRIC CARE.** What do the following symbols mean? Match the symbols with the correct instructions.

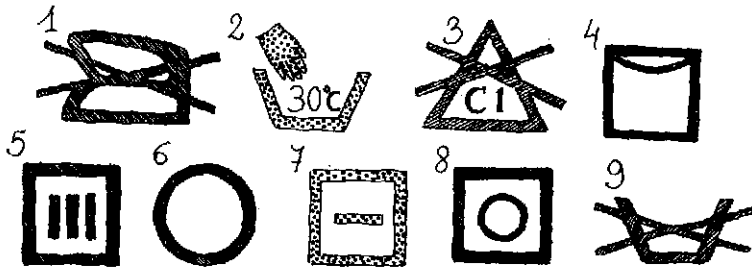

- | | |
|---------------------------------|--------------------|
| ... do not wash | ... hang to dry |
| ... hand-wash in lukewarm water | ... drip-dry |
| ... do not use chlorine bleach | ... do not iron |
| ... dry flat | ... dry-clean only |
| ... tumble dry | |

46. **FABRIC CARE — WASHING.** Choose the correct answer.

1. If you don't know how to wash that sweater, look at the inside the collar.
 - a) badge
 - b) label
 - c) notice
 - d) sign
2. Using that washing powder, clothes seem to quicker.
 - a) deaden
 - b) decline
 - c) wear out
 - d) worsen
3. These jeans when washed in hot water.
 - a) decrease
 - b) lessen
 - c) reduce
 - d) shrink
4. Leave the shirt to in cold water overnight and the stains will soon come out.
 - a) drench
 - b) drip
 - c) float
 - d) soak

5. Making colours vanish is one of my machine's features.
a) certain b) only c) solitary d) unique
6. Even after I'd washed the dress, it still had some marks on it.
a) faint b) thin c) uncertain d) weak
7. I'm afraid this stain on your jacket just won't
a) come out b) die out c) go away d) make off
8. The blue curtains began to after they had been hanging in the sun for a year.
a) die b) dissolve c) fade d) melt
9. My woollen sweater used to be bigger than this: it in the wash!
a) lessened b) reduced c) shortened d) shrank
10. The car raced through a puddle and mud all over my new fur coat.
a) scattered b) splashed c) sprayed d) sprinkled
11. My wife boiled my nylon shirts and they are quite
a) broken b) damaged c) destroyed d) ruined
12. The washing is not quite dry, it needs
a) airing b) heating c) rinsing d) warming

47. FABRIC CARE — IRONING. *Choose the correct answer.*

1. Could I borrow an iron to my dress?
a) flatten b) press c) smooth d) straighten
2. Walkers need clothes made of a material which doesn't mind being
a) bent b) creased c) folded d) wrinkled
3. Unless you pack your trousers more carefully, they will get
a) creased b) folded c) spoilt d) wrinkled
4. Her skirt had been so in packing that she had to iron it before going out.
a) crumpled b) dirty c) faded d) torn
5. You should iron out the in that dress.
a) creases b) crumples c) folds d) wrinkles

48. FABRIC CARE. *Put each of the following words in its correct place in the passage below.*

calfskin	corduroy	creased	directions
drip	fabrics	garments	hung
leather	lukewarm	polished	shoes
squeezed	suede	supple	tags
washing	wearing	woollen	wringing

Cleaning

It is as well to read all those little that dangle from The tags give for cleaning or, and pressing.

Most sweaters can be hand-washed in or cold water. They should be gently, not wrung out.

Some, such as should be left to dry without squeezing or

Some garments that are after a wearing may lose these creases if they are carefully up overnight.

..... pocketbooks and should be brushed before and after each

Kid and shoes should be to keep the soft and

49. FASTENERS. Match each of the following fasteners with the correct picture below.

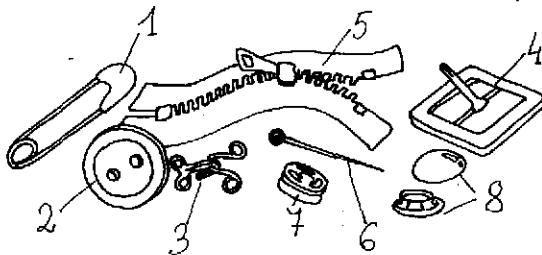

... buckle

... button

... hook and eye

... pin

... press stud

... safety-pin

... snap/popper

... zipper/zip

50. FASTENERS. Choose the right answer.

1. She her overcoat, took it off and laid it over a chair.

- a) unbuttoned b) uncovered c) untied d) unwrapped

2. He was so wet after the storm that he went upstairs to his clothes.

- a) alter b) change c) put on d) wear

3. When it is very hot, you may the top button of your shirt.

- a) undo b) undress c) untie d) unwrap

4. She was well up in a thick fur coat.

- a) folded b) packed c) rolled d) wrapped

5. your coat. The wind is very cold today.

- a) Do up b) Make up c) Put off d) Take on

6. If you are going to stay, why don't you your coat?

- a) lift off b) move off c) put off d) take off

51. SEWING. Give the names of the following items connected with sewing.

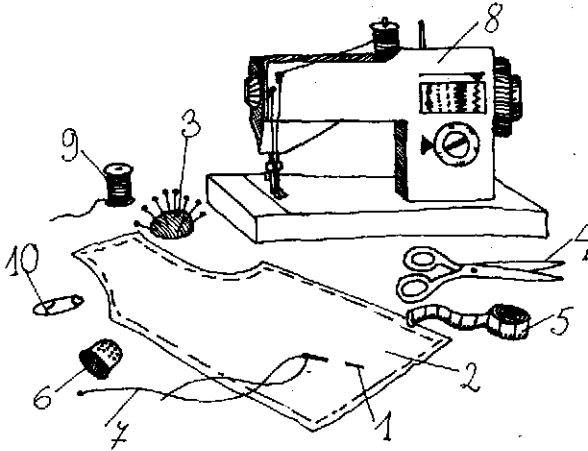

- | | |
|---------------------|----------------------|
| 1. _____ l _____ | 6. th _____ |
| 2. p _____ | 7. th _____ |
| 3. p _____ cu _____ | 8. s _____ m _____ |
| 4. _____ s _____ | 9. r _____ of cotton |
| 5. t _____ m _____ | 10. s _____ p _____ |

52. SEWING. Choose the right answer.

1. Grandma was sitting by the fire a sock.
a) embroidering b) knitting c) manufacturing d) weaving
2. The dressmaker the half-finished blouse but it was obviously too small.
a) put on b) tested c) tried on d) tried out
3. I like the large in your skirt, Mary.
a) creases b) folds c) pleats d) wrinkles
4. When short skirts became unfashionable, I had to have all my dresses
a) elongated b) let down c) prolonged d) protracted
5. His jeans were so tight, they when he sat down.
a) broke b) cracked c) snapped d) split
6. Her skirt was too long so she had to
a) let it down b) let it in c) take it in d) turn it up
7. My broke on my way to work today and my skirt nearly fell down!
a) coat b) hook c) patent d) zip
8. That man's coat has got such wide shoulders, they must be
a) padded b) quilted c) stuffed d) starched
9. She had to her dress because she had lost so much weight.
a) alter b) change c) loosen d) shift

10. Nowadays many skirts are permanently and need no ironing.
a) creased b) folded c) gathered d) pleated
11. You have a (n) in the sleeve of your sweater.
a) gap b) hole c) opening d) space
12. My mother doesn't like buttons on my shirts.
a) attaching b) connecting c) fixing d) sewing
13. He asked his wife to the hole in his socks.
a) amend b) cure c) mend d) repair
14. I can't fasten this skirt; it's too
a) loose b) rough c) tight d) wide

53. BUYING CLOTHES. *Choose the right answer.*

1. Two hundred and fifty pounds is too much for that coat. It's just not it.
a) bargain b) deal c) value d) worth
2. She said that she could not a new dress on her small salary.
a) afford b) save c) spare d) spend
3. I'll have to buy trousers.
a) a b) a couple of c) a pair of d) two
4. Margaret has been trying to persuade her husband to buy her a new fur
a) dress b) handkerchief c) muff d) scarf
5. I the blouse in the fitting-room but it was obviously too small.
a) tried b) tried on c) tried out d) wore
6. She couldn't make up her whether to buy the green skirt or the red one.
a) brain b) head c) heart d) mind
7. Because of her small salary, Betty often buys clothes at that stall in the market.
a) second-best b) second chance c) second-class d) secondhand
8. She wanted to buy a modern dress, she didn't want an old one.
a) formed b) fashioned c) shaped d) styled
9. Look at that beautiful brooch! I only paid \$3 for it at the sale. It was a real
a) affair b) bargain c) benefit d) occasion
10. I liked the coat but was rather off by the price.
a) held b) put c) set d) shaken
11. Would you like to the costume to see if it fits you?
a) approve b) experience c) experiment d) try on
12. You'll be your money if you buy that hat: you will never wear it.
a) giving away b) losing c) saving d) wasting

54. BUYING CLOTHES. *Choose the right answer.*

1. I can't afford a new pair of shoes, alone a fur coat.
a) all b) even c) except d) let
2. There is a good of cardigans in that store.
a) offering b) presentation c) production d) selection
3. These trousers are too I'll have to get a bigger pair.
a) close b) loose c) narrow d) tight
4. I'm afraid none of our material will exactly the colour of your sample.
a) equal b) fit c) imitate d) match
5. The cost of the material is in the bill for the work.
a) combined b) enclosed c) held d) included
6. Karen is very, she is always buying clothes she cannot really afford.
a) exorbitant b) expensive c) extravagant d) extrovert
7. I wanted to buy you a dress when I was in England, but I didn't know your
a) cut b) measure c) size d) waist
8. This scarf is available in a wide of colours.
a) line b) range c) spread d) scale
9. A tailor you for a new suit.
a) examines b) measures c) metres d) sizes
10. All these sweaters are by the local people on a small Scottish island.
a) founded b) knit c) made d) worn

*** 55. CLOTHING.** *Choose the right answer.*

1. The **BLEACHING** of fabrics by sunlight is at least partly a photochemical process.
a) airing
b) drying
c) scrubbing
d) whitening
2. Natural silk is obtained by **UNRAVELLING** the thin threads of the cocoons spun by the caterpillars of the silkworm moth.
a) undertaking
b) undulating
c) unleashing
d) unwinding
3. The man was **CLAD IN** a black suit and a grey felt hat.
a) buying
b) carrying
c) looking for
d) wearing

4. Cotton CLOTH has been found among the ruins left by some early American Indians.
- clothing
 - fabric
 - tapestry
 - thread
5. Linen could not be manufactured by machine until recently because the fibres break READILY under tension.
- easily
 - ultimately
 - unevenly
 - unexpectedly

56. CLOTHING. Give the right word.

- People thought that _____ n _____ s would replace the miniskirt with something more modest.
- His shirts were dirty and his wife on holiday, so he had to send them to the _____ d _____.
- You use _____ to change the colour of clothes.
- This coat was a fantastic _____ g _____ ! It cost only \$ 10.
- If your clothes are very dirty you had better leave them in a bucket of water to _____ a _____ overnight.
- I wouldn't buy this sweater if I were you. It is all right now, but I am sure it will _____ n _____ the first time you wash it and then it will be too small.
- She is dressed in _____ because her husband died last week.
- I can't _____ f _____ to buy you this fur coat. It's much too expensive.
- He hung his coat on the coat _____ c _____ in the entrance hall.
- "What do you think about my new dress?" "I think that that _____ h _____ of blue doesn't really suit you well".

57. ELEGANCE. Match the styles with the pictures.

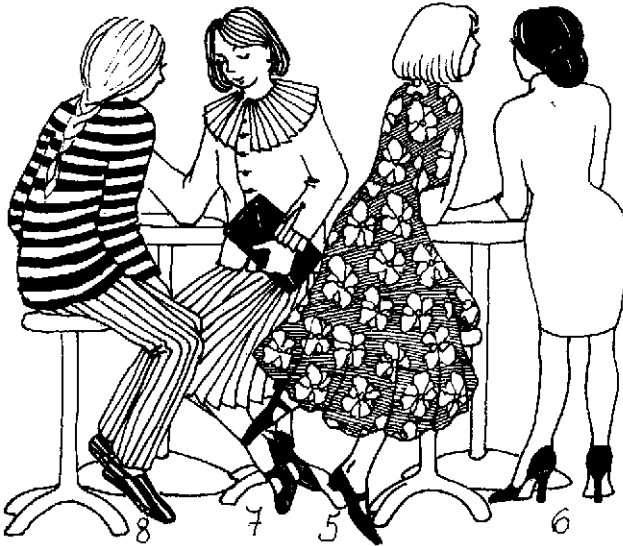
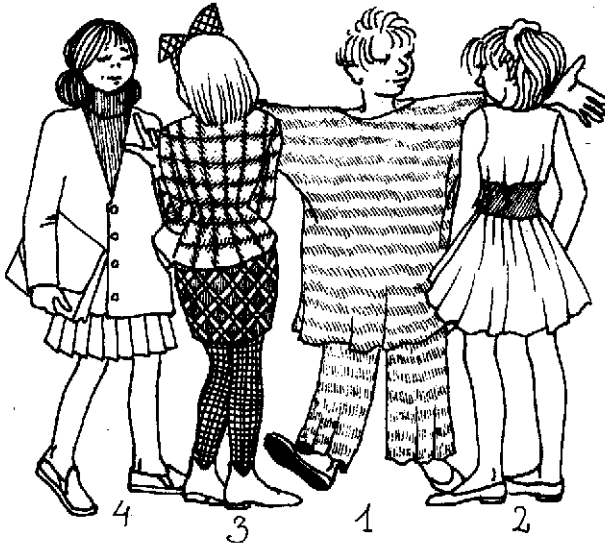

... baggy
... belted

... checked
... crew neck

... floral
... high-heeled

... pleated
... striped

58. **JEWELLERY AND ORNAMENTS.** Give the names of the following items of jewellery and ornaments.

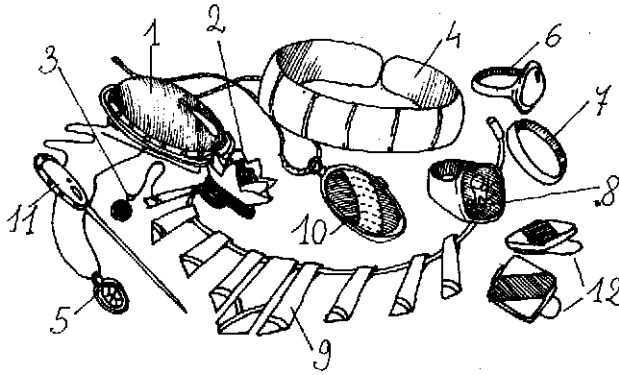

- | | |
|--------------------------|---------------------|
| 1. _____ o _____ | 7. _____ d _____ |
| 2. _____ l _____ r _____ | 8. s _____ |
| 3. _____ r _____ r _____ | 9. _____ k _____ |
| 4. _____ e _____ | 10. _____ d _____ |
| 5. _____ h _____ | 11. t _____ p _____ |
| 6. _____ | 12. c _____ |

59. **JEWELLERY AND ORNAMENTS.** Choose the right answer.

- She wore a beautiful of pearls round her neck.
a) band b) bracelet c) ring d) string
- "What a beautiful pearl necklace!" "The pearls are not, I'm afraid."
a) actual b) good c) real d) true
- She wore a dark red velvet dress, with a diamond round her neck.
a) bracelet b) collar c) necklace d) string
- Cathy was wearing a black leather belt with a big silver
a) buckle b) button c) fastener d) link
- Although it was only jewellery, it looked real enough.
a) fictional b) imitation c) invented d) untrue
- Her chain was made of gold, unmixed with any other metal.
a) clean b) dishonest c) pure d) right

60. **ACCESSORIES.** Choose the correct answer.

- She kept her money in a brown leather
a) package b) packet c) parcel d) purse
- I must buy a new leather to go round my suitcase.
a) rope b) strap c) string d) thread

3. If your belt is too tight, you should it.
a) lengthen b) loose c) loosen d) release
4. I gave her stockings for her birthday.
a) a b) a couple of c) any d) a pair of
5. George is wearing the blue and red tie I gave him.
a) designed b) lined c) pictured d) striped
6. He left his at the station and went sightseeing.
a) handbag b) purse c) sack d) suitcase
7. Can you that strange perfume she is wearing?
a) feel b) notice c) see d) smell
8. Bright colours don't her pale skin.
a) agree b) fit c) match d) suit
9. Please in mind that your appearance and dress are very important.
a) bear b) carry c) have d) hold
10. I gave Mary a black silk scarf with pink
a) balls b) marks c) spots d) stains

61. FOOTWEAR. Match each of the following types of footwear with the correct number in the picture below.

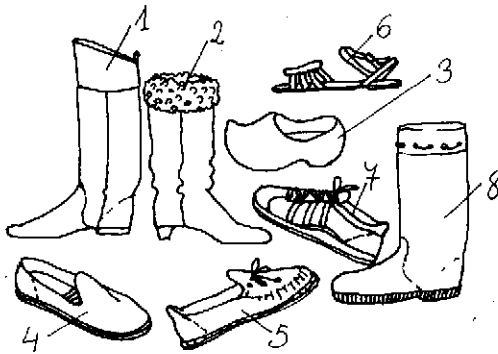

- | | |
|----------------|---------------------------|
| ... boot | ... moccasin |
| ... clog | ... slipper |
| ... sandal | ... training shoe/trainer |
| ... wellington | ... riding-boot |

* 62. FOOTWEAR. Match the following names of footwear with their descriptions.

- | | |
|---------------|---|
| 1. boot | a. a loosefitting shoe with uppers made from soft material, worn in the house |
| 2. clog | b. a heel-less shoe of deer skin or soft leather |
| 3. moccasin | c. a kind of open shoe worn in summer |
| 4. mule | d. a long-legged rubber boot made in one piece |
| 5. pump | e. a kind of light, soft shoe worn for sport, dancing, etc. |
| 6. sandal | f. footwear heavier than a shoe with a part for supporting the ankle |
| 7. slipper | g. a shoe with no back, but only a piece across the toes to hold it on |
| 8. wellington | h. a shoe with a sole made of wood |

63. FOOTWEAR. Match each of the following parts of the shoe with the correct number in the picture below.

- ... eyelet
- ... heel
- ... shoe-lace
- ... lining
- ... sole
- ... toe-cap
- ... tongue
- ... upper

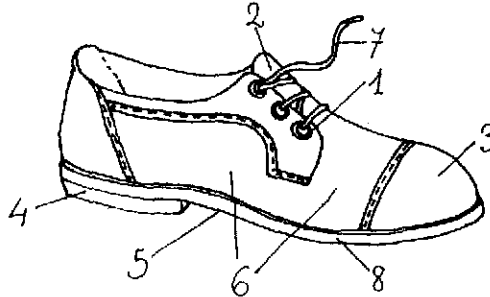

64. FOOTWEAR. Choose the right answer.

1. I don't know how you manage to walk with such high on your shoes.
a) heels b) laces c) straps d) toes
2. Her shoes were so old that her were sticking out of them.
a) fingers b) thumbs c) tips d) toes
3. What shoes do you take?
a) length b) measure c) scale d) size
4. No, these shoes my toes. Let me try a larger size, please.
a) break b) compress c) hold d) pinch
5. The first thing he did was to his shoelaces and take his shoes off.
a) disconnect b) mislead c) unpack d) undo
6. These leather shoes are made
a) at hand b) by hand c) in hand d) with hand
7. If I could these shoes a little, ~~they~~ they would be much more comfortable.
a) expand b) grow c) increase d) stretch

8. She bought some green shoes to her green dress and handbag.
 a) equal b) match c) mate d) pair
9. You need a good pair of boots for mountain climbing.
 a) rough b) rude c) rusty d) tough
10. You'll have to buy some new shoes as these are
 a) broken down b) gone off c) used up d) worn out
11. Your shoes are a(n) ! You haven't cleaned them for weeks.
 a) accident b) blow c) disgrace d) shock
12. You really ought to your shoes repaired.
 a) do b) get c) make d) take

65. FOOTWEAR. Put each of the following words in its correct place in the passage below.

bones	bought	choose	chosen	feet
fit	pain	place	properly	protect
quality	shape	shoes	size	

Shoes and Health

Shoes should be with the idea that they are made to and support the
 They should be for shape, and the of the material.

..... is no guarantee that will fit, and people should shoes that follow
 the of the foot. Only with fitting shoes will the wearer avoid the of having
 the small of the foot pushed out of

66. HAIR AND HEADGEAR. Match the names of the following headgear with the correct number in
 the picture below.

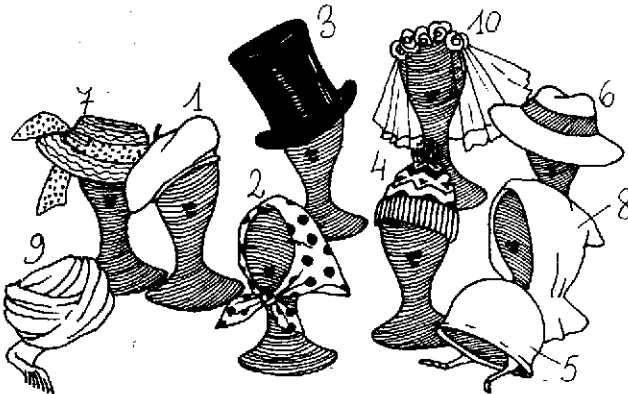

- | | | | |
|---------------|---------------|------------|------------|
| ... felt hat | ... cap | ... hood | ... turban |
| ... straw hat | ... beret | ... helmet | |
| ... top hat | ... headscarf | ... veil | |

67. HAIR AND HEADGEAR. Complete the sentences below.

1. You (szczotkować) _____ your hair with a (szczotka do włosów) _____
2. You can also (czesać) _____ it with a (grzebień) _____
3. When you want a nice wave in your hair you can put in (wałki) r _____ s.
4. When you are not satisfied with the colour of your hair you can (ufarbować) _____ it.
5. (Łysi) _____ people sometimes wear (peruki) _____ s.
6. Women often go to a (fryzjer) _____ to get a new (fryzura) _____ d _____

*** 68. HAIR AND HEADGEAR.** Choose the right answer.

1. "How would you like your hair cut, sir?" "Just a , please."
a) cut b) snip c) shave d) trim
2. You look very different with your hair on the right.
a) combed b) divided c) parted d) separated
3. The new hairdresser is very expensive. I had to pay \$18 just for a shampoo and
a) comb b) fix c) set d) wash
4. Her hair was tied back in a
a) biscuit b) bun c) cake d) loaf
5. She is always wearing a strange red hat with a long in it.
a) hair b) feather c) fur d) tail
6. I don't like the she does her hair.
a) arrangement b) fashion c) manner d) way
7. He wore a moustache and beard to the fancy-dress ball.
a) cheated b) counterfeit c) false d) untrue
8. Would it be possible to make an early? to have my hair cut tomorrow?
a) appointment b) arrangement c) date d) engagement
9. She often wears a hat to protect her head when the sun is very hot.
a) felt b) fur c) straw d) top
10. She tied her round her head to protect her hair from the rain.
a) belt b) glove c) scarf d) umbrella

69. COLOURS. Choose the right answer.

1. The dress was a nice of green.
a) cloth b) colouring c) material d) shade
2. I never wear yellow because it doesn't me.
a) assist b) fit c) match d) suit

3. The colour of the dress was quite different under light.
 a) artificial b) artistic c) false d) imitation
4. The mysterious lady was dressed in black.
 a) all over b) back to front c) from head to toe d) from top to bottom
5. Her blue dress the colour of her eyes.
 a) fitted b) liked c) matched d) paired

70. COLOURS. Crossword:

ACROSS:

2. the colour of a sour fruit (5)
 5. yellowish-white (5)
 7. colour of grass (5)
 8. opposite of dark (4)
 11. colour for a cardinal (6)

DOWN:

1. signifies death (5)
 3. red and yellow mixed (6)
 4. colour of earth, wood, or coffee beans (5)
 6. colour of fire and blood (3)
 9. light blue (5)
 10. colour of the sky (4)

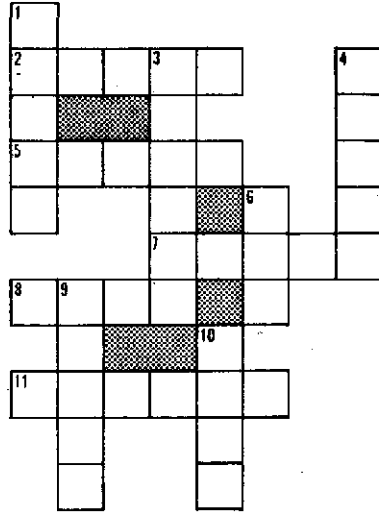

V. Crime and Punishment



“Are these your witnesses?”

“They are.”

“Then you win. I’ve used them as witnesses twice myself.”

*

“And now, Mrs Smith,” said lawyer, “will you be kind enough to tell the jury whether your husband was in the habit of striking you with impunity?”

“With what, sir?”

“With impunity.”

“He was, sir, now and then; but he struck me oftener with his fist.”

* 71. **CRIME.** Put each of the following words and phrases into its correct place in the passage below.

- | | | | |
|--------------|----------|--------------|-------------------|
| bigamy | civil | classes | community |
| countries | crimes | criminal law | felony |
| fine | forgery | laws | life imprisonment |
| misdemeanour | offences | penalty | person |
| prison | state | term | treason |

Crime

Crime violates the laws of a community, or nation. It is punishable in accordance with these The definition of crime varies according to time and place, but the laws of most consider as crimes such as arson, , burglary, , murder, and

Not all offences against the law are The laws that set down the punishments for crimes form the This law defines as crimes those offences considered most harmful to the On the other hand, a may wrong someone else in some other way that offends the law.

The common law recognizes three of crime: treason, , and misdemeanour. Death or is the usual for treason. Laws in the United States, for example, define a felony as a crime that is punishable by a of one year or more in a state or federal A person who commits a may be punished by a or a jail term of less than one year.

72. **LAW BREAKERS.** Give the name of the defined law breaker.

- | | |
|---|-----------------|
| 1. steals | a _____ |
| 2. steals purses and wallets | a _____ k _____ |
| 3. gets money by threatening to disclose personal information | a _____ k _____ |
| 4. seizes aeroplanes | a _____ j _____ |
| 5. takes things from a shop without paying | a _____ i _____ |
| 6. kills people | a _____ r _____ |
| 7. steals from houses or offices | a _____ g _____ |
| 8. steals from banks or trains | a _____ b _____ |
| 9. takes people hostage for a ransom | a _____ n _____ |
| 10. steals government secrets | a _____ |
| 11. wilfully destroys property | a v _____ |
| 12. marries illegally while being married already | a b _____ |

73. LAW BREAKERS. *Choose the correct answer.*

1. This was one of the few crimes he did not
a) achieve b) commit c) make d) perform
2. The are still holding twelve people hostage on the plane.
a) bandits b) guerrillas c) hijackers d) kidnapers
3. He was charged with a(n) of currency regulations.
a) break b) breach c) disrespect d) observance
4. Our insurance policy offers immediate against the risk of burglary, accident or damage by fire.
a) care b) cover c) relief d) security
5. The man jumped out of the window and committed
a) death b) homicide c) murder d) suicide
6. "Thieves will be"
a) liable b) lifted c) persecuted d) prosecuted
7. Police blamed a small hooligan in the crowd for the violence which occurred.
a) constituent b) division c) element d) portion
8. The police said there was no sign of a entry even though the house had been burgled.
a) broken b) burst c) forced d) smashed
9. The police car raced down the street with the blaring.
a) alarm b) bell c) gong d) siren
10. The tourist's camera was because he had brought it into the country illegally.
a) bereaved b) confiscated c) deprived d) extorted
11. Look, Officer. I'm not drunk. I'm as as a judge.
a) calm b) clear c) sober d) steady
12. He said he would sue us, but I don't think he'll his threat.
a) achieve b) bring about c) carry out d) perform
13. The conspirators were plotting the of the government.
a) catastrophe b) disaster c) demolition d) overthrow
14. The thieves the papers all over the room while they were searching for the money.
a) broadcast b) scattered c) sowed d) strayed
15. Ms Goodheart was completely by the thief's disguise.
a) taken away b) taken down c) taken in d) taken up
16. The police caught the thief
a) in black and white b) in the red c) red-handed d) true blue
17. He was arrested for trying to pass notes at the bank.
a) camouflaged b) counterfeit c) fake d) fraudulent
18. He offered me \$ 500 to break my contract. That's
a) blackmail b) bribery c) compensation d) reward
19. The child was kidnapped by a notorious of robbers.
a) crew b) gang c) staff d) team
20. The burglar silently into the room.
a) crept b) stood c) strode d) wandered

*** 74. LAW BREAKERS.** Match the criminal with the definition.

- | | |
|-----------------------|---|
| 1. an arsonist | a) tries to enforce his political demands by carrying out or threatening acts of violence |
| 2. an assassin | b) pretends or claims to be what he is not |
| 3. a deserter | c) makes money by dishonest business methods, e.g. by selling worthless goods |
| 4. an embezzler | d) steals from his own company |
| 5. a forger | e) attacks and robs people especially in public places |
| 6. a fraud or con man | f) sets fire to property |
| 7. a hooligan | g) kills for political reasons or reward |
| 8. a mugger | h) brings goods into one country from another illegally |
| 9. a poacher | i) hunts illegally on somebody else's land |
| 10. a racketeer | j) makes false money or documents |
| 11. a smuggler | k) a soldier who leaves the armed forces without permission |
| 12. a terrorist | l) causes damage or disturbance in public places |

*** 75. LAW BREAKERS.** Choose the right answer.

- The spy the desk in an attempt to find the secret documents.
a) invaded b) kidnapped c) looted d) ransacked
- The safe deposit box a high-pitched sound when it was moved.
a) ejected b) emitted c) expelled d) excluded
- He his fist and threatened to hit me.
a) clenched b) clutched c) grabbed d) gripped
- Thieves got away with a of jewellery worth thousands of pounds.
a) catch b) haul c) loot d) snatch
- The burglar's presence was betrayed by a floorboard.
a) cracking b) creaking c) crunching d) groaning
- Smugglers consistently import regulations.
a) break b) flaunt c) float d) flout
- Luckily my wallet was handed in to the police with its contents
a) contained b) intact c) missing d) preserved
- The intruder was badly by the guard dog in the palace garden.
a) damaged b) eaten c) mauled d) violated
- When the police examined the house they found that the lock had been with.
a) broken b) hindered c) tampered d) touched
- The hooligan the money out of my hand and ran away.
a) clutched b) gripped c) snatched d) withdrew

76. **LAW BREAKERS.** By moving vertically or horizontally (forwards or backwards) find twelve kinds of criminal.

D	F	G	S	P	Y	V	K	J	D	H	Y	S	I	E	K	L	M	S	N	B
M	N	B	H	I	J	A	C	K	E	R	M	N	H	Y	S	H	D	L	K	J
N	G	V	O	G	H	N	A	W	E	R	T	Y	U	I	O	P	L	K	J	H
I	M	N	P	B	V	D	X	A	S	W	E	R	F	D	F	G	G	H	J	F
S	J	H	L	L	O	A	K	K	I	D	N	A	P	P	E	R	S	G	T	A
S	N	B	I	U	Y	L	S	E	R	T	P	I	C	K	P	O	C	K	E	T
A	W	E	F	S	D	F	G	H	J	K	L	M	N	C	V	B	S	E	R	H
S	A	W	T	E	R	R	E	L	I	A	M	K	C	A	L	B	W	A	S	I
S	A	W	E	E	R	T	Y	G	F	M	U	R	D	E	R	E	R	D	F	E
A	A	S	R	W	E	R	T	Y	U	B	U	R	G	L	A	R	S	D	V	F

77. **POLICE.** Choose the right answer.

- The policeman asked the suspect to make a(n)
a) account b) declaration c) deposition d) statement
- The unruly was broken up by the police.
a) collection b) congregation c) group d) mob
- Prince Andrew was found dead in his palace this morning. The police have any suggestion of foul play.
a) discounted b) neglected c) omitted d) overlooked
- The chief of police said that he saw no between the four murders.
a) communication b) connection c) join d) joint
- The detective stood behind the door waiting for the assailant.
a) immovable b) lifeless c) motionless d) static
- The police arrested the wrong man mainly because they the names they had been given by the witness.
a) bewildered b) confused c) merged d) puzzled
- The police off the street where the bomb had gone off.
a) battened b) cordoned c) fastened d) shuttered
- The police set a to catch the thieves.
a) device b) plan c) snare d) trap
- The police asked if I thought I could the man who stole my car if I looked at some photos.
a) certify b) identify c) justify d) verify
- The policeman was when he saw a light in the office.
a) deductive b) disturbing c) suggestive d) suspicious
- The inspector was a very man and he rechecked the evidence several times.
a) attentive b) complete c) thorough d) thoughtful
- The police who were the crime could find no clues at all.
a) enquiring b) investigating c) researching d) seeking

13. We promise not to reveal your if you tell us who the murderer is.
a) anonymity b) identification c) identity d) personality
14. The police are the town for the stolen car.
a) combing b) investigating c) looking d) seeking
15. The police have not yet found a possible for the murder.
a) example b) motive c) principle d) understanding
16. The police their attention to the events that led up to the accident.
a) completed b) confined c) confirmed d) contained
17. As he was caught in of a gun, he was immediately a suspect.
a) control b) handling c) ownership d) possession
18. As the result of the police on the disco, ten people were arrested.
a) entry b) invasion c) raid d) storm
19. I was informed by the police constable that he would be forced to take me into
a) confinement b) custody c) detection d) guardianship
20. It is the responsibility of the police to the law, not to take it into their own hands.
a) compel b) enforce c) force d) press
21. After the accident the policeman asked if there had been any
a) observers b) onlookers c) spectators d) witnesses
22. The police were in their examination of the murder site.
a) concentrated b) exhausting c) intense d) thorough
23. The police made sure everyone stood well of the fire.
a) away b) clear c) free d) out
24. Why don't the police take measures against crime?
a) affective b) effective c) efficient d) ineffective

78. TRIAL. *If you commit a crime you may be:*

accused
arrested
charged
convicted
interrogated
paroled
sent to prison
suspected
tried

Put these actions in the correct order.

79. TRIAL. Choose the right answer.

1. The sentenced the accused to 15 years in prison.
a) barrister b) counsel c) judge d) solicitor
2. If you can't resolve the dispute, it will have to be settled by
a) arbitration b) court c) election d) referee
3. His comments little or no relation to the facts of the case.
a) bear b) give c) possess d) reflect
4. They all thought he was guilty, but no one could anything against him.
a) accuse b) ensure c) point d) prove
5. It has been decided to hold a Public into the cause of the accident.
a) Autopsy b) Examination c) Inquiry d) Interrogation
6. To protect victims of blackmail their names are often in court.
a) covered b) erased c) hidden d) not given
7. The youth involved in the disturbance at the demonstration made a(n) to the police.
a) account b) notice c) statement d) summary
8. I to say anything unless I am allowed to speak to my solicitor.
a) deny b) neglect c) refuse d) resist
9. I should like to call two who can testify on my client's behalf.
a) witnesses b) onlookers c) passers-by d) spectators
10. You are surely not suggesting that these young children could have planned such an evil deed.
a) innocent b) lovely c) natural d) pure
11. The case against Mary Wrongdoer was for lack of evidence.
a) discarded b) dismissed c) refused d) resigned
12. The new law comes into on May 15.
a) condition b) date c) force d) power
13. The question in this case is whether the accused had a motive for this crime or not.
a) crucial b) forcible c) supreme d) valuable
14. The driver admitted that the accident was partly his own
a) blame b) cause c) evil d) fault
15. In fact, the murderer was from the country before extradition proceedings could be started.
a) barred b) deported c) exported d) interned
16. The suspect man has a on his right cheek.
a) point b) scar c) sign d) trace
17. It is a criminal offence to the facts.
a) express b) oppress c) repress d) suppress
18. After a close cross-examination, the barrister was his client was telling the truth.
a) content b) glad c) happy d) satisfied
19. At the end of the trial he was of murder.
a) condemned b) convicted c) convinced d) penalised

20. In the legal profession, men women by five to one.
 a) outclass b) outnumber c) overcome d) supersede
21. All barristers are expected to study at the Inns of Court.
 a) hopeful b) prospective c) willing d) wishful
22. The judge will hear the next after lunch.
 a) case b) charge c) lawsuit d) trial
23. The suspect that he had assaulted a policeman.
 a) contradicted b) declined c) denied d) refused
24. I wish you'd let me speak for myself and not the words out of my mouth.
 a) grab b) pull c) snatch d) take
25. The suspect is to have been in the neighbourhood at the time of the crime.
 a) accused b) affirmed c) alleged d) announced

80. TRIAL. *Choose the right answer.*

1. The high court judge will pass next week.
 a) justice b) punishment c) sentence d) verdict
2. If you break the law, you will be trouble.
 a) for b) in c) out d) out of
3. The judge was very on pickpockets.
 a) bad b) hard c) strict d) strong
4. It was impossible for her to tell the truth so she had to a story.
 a) combine b) invent c) lie d) manage
5. Peter gives one account of the accident, and John another; it is difficult to the two versions.
 a) adjust b) coincide c) identify d) reconcile
6. The witness testified that he could bear what the defendant had claimed.
 a) on b) out c) up d) with
7. The suspect is not under arrest, nor have the police placed any on his movements.
 a) obstacle b) regulation c) restriction d) veto
8. You should only make serious accusations like that if they have a sound in fact.
 a) basis b) foothold c) framework d) principle
9. The judge the pedestrian for the accident.
 a) accused b) blamed c) charged d) sued
10. His legal training enables him to put his case very convincingly.
 a) down b) out c) over d) up

*** 81. PUNISHMENT. Match each punishment with its description.**

- | | |
|--------------------------|--|
| 1. capital punishment | a) a period of time in jail |
| 2. corporal punishment | b) being made to do specially hard work while in prison |
| 3. eviction | c) death |
| 4. a heavy fine | d) a punishment imposed only if you commit a further crime |
| 5. internment | e) a large sum of money to pay |
| 6. penal servitude | f) whipping or beating |
| 7. a prison sentence | g) regular meetings with a social worker |
| 8. probation | h) removing (a person) from a house or land by law |
| 9. solitary confinement | i) limiting the freedom of movement esp. for political reasons |
| 10. a suspended sentence | j) being imprisoned completely alone |

82. PUNISHMENT. Choose the right answer.

- The community was angered by the punishment given their friend.
a) august b) austere c) severe d) vigorous
- Those acting for the defendant propose to appeal the sentence.
a) against b) for c) out d) to
- Mr Topsy was twenty pounds for drinking and driving.
a) charged b) fined c) ordered d) penalized
- The ringleader was lucky to get a suspended sentence.
a) away b) off with c) through d) through to
- After considering the case, the judge put the young offender for two years.
aa) in charge b) in control c) on probation d) on trial
- Despite the seriousness of his crime he only received a sentence.
a) light b) little c) small d) soft
- The young offenders were warned never with the members of any gang.
a) to assign b) to assimilate c) to associate d) to assume
- As it was her first offence, the judge gave her a sentence.
a) kind b) lenient c) severe d) tolerant
- The woman for her husband's life when he was found guilty of murder.
a) bid b) debated c) disputed d) pleaded
- The accused man was able to prove his innocence at the trial and was
a) absolved b) acquitted c) forgiven d) pardoned
- Jack the Ripper was a hardened criminal without a scrap of for his crimes.
a) penance b) pity c) remorse d) reproach
- His sentence has been commuted to five months on the of failing health.
a) bases b) causes c) grounds d) reasons

13. The prisoners had spent almost a month digging a before the guards discovered it.
 a) pipe b) pass c) subway d) tunnel
14. He was thrown into prison and of his property.
 a) confiscated b) denied c) deprived d) removed

*** 83. PUNISHMENT.** Put each of the following words and phrases into its correct place in the passage below.

accused	acquit	civil suits	counsel
court	cross-examinations	fault	guilty
judge	jurors	jury	legal disputes
legislature	list	money	officer
panel	sentence	swear	testimony
trial	witnesses		

Trial by Jury

A jury is a selected group of laymen that hears the in and decides the facts. A courtroom trial in which a decides the facts is called a by jury.

Before each term, a jury commissioner or another public prepares a panel, or large initial of qualified jurors. For each trial, are selected by lot from this Before the trial begins, the jurors to decide the facts fairly. They hear the given by witnesses for both sides, including Then for each side sum up, or summarize the case, and the explains the applicable law in his instructions to the jury.

In for financial damages, the jury must decide who is at and must determine the amount of to be paid. In criminal cases, the jury must decide whether or not the is guilty "beyond a reasonable doubt", and then either return a verdict of guilty, or the defendant by a verdict of not guilty. If the verdict is the judge imposes the , or punishment, within limits that have been fixed by the

*** 84. CRIME AND PUNISHMENT.** Choose the right answer.

- There is no doubt about the outcome of the trial. The man is a criminal.
 a) self-centred b) self-confessed c) self-conscious d) self-contained
- If the terrorists are not sent to prison, there will be a public
 a) attack b) onslaught c) outcry d) recrimination
- It is often difficult for ex-convicts to keep to the and narrow.
 a) deep b) long c) straight d) wide
- When the detectives finally trapped him, he had to to lying.
 a) recourse b) resort c) resource d) retort
- The judge recommended more humane forms of punishment for juvenile
 a) convicts b) delinquents c) sinners d) villains

6. The murderer proved to be an apparently well-behaved middle-aged woman.
a) inoffensive b) offensive c) unoffending d) unsuspecting
7. He found some squatters living in his house so he asked the court for a speedy order.
a) discharge b) ejection c) eviction d) expulsion
8. The witness the statements made by the accused man.
a) agreed b) confessed c) corroborated d) testified
9. A prominent local figure was as co-respondent in a divorce case.
a) accused b) cited c) nominated d) quoted
10. The whole story was a of her imagination.
a) fabrication b) fantasy c) figment d) figure
11. As she was the murderer's mother, the judge the normal restrictions on visits and let her see him.
a) abandoned b) lifted c) relinquished d) surrendered
12. The baby at the centre of the controversy has been made a of court.
a) child b) progeny c) protegee d) ward
13. After considering the evidence for a few hours, the Jury came to a(n) verdict.
a) unambiguous b) unanimous c) undivided d) united
14. It was a reasonable to draw in the light of the evidence.
a) assessment b) conclusion c) interpretation d) verdict
15. Ms Stickyfinger was charged with the funds of the organization.
a) misappropriating b) mislaying c) mistaking d) misplacing

85. CRIME AND PUNISHMENT. *Choose the word or phrase that best keeps the meaning of the original sentence if it is substituted for the capitalized word.*

1. A smiling face often disguises the mind and heart of a VILLAIN.
a) a foolish man
b) a lying man.
c) an unhappy man
d) a wicked man
2. At first the accident seemed to be TRIVIAL.
a) critical
b) momentous
c) significant
d) unimportant
3. There was no TRACE of poison in the coffee the chemist analyzed.
a) colour
b) indication
c) smell
d) taste

4. The FROWN on the judge's face showed that he was displeased.
 - a) look of anger
 - b) look of delight
 - c) look of fear
 - d) look of surprise
5. The night was so FOGGY that the murderer was easily able to escape his pursuers.
 - a) messy
 - b) mild
 - c) misty
 - d) moist
6. The driver tried to AVERT the accident by bringing the car to a sudden stop.
 - a) cause
 - b) control
 - c) minimize
 - d) prevent
7. The indecisive man was READILY persuaded to change his mind again.
 - a) abruptly
 - b) easily
 - c) hardly
 - d) subtly
8. The officer COMPELLED the prisoner to do exactly as he wished.
 - a) allowed
 - b) beseeched
 - c) forced
 - d) hired
9. The criminal INSINUATED that he had been roughly treated by the arresting officer.
 - a) argued convincingly
 - b) denied positively
 - c) stated flatly
 - d) suggested indirectly
10. The boy felt DISGRACED because he knew that he had been wrong to steal.
 - a) ashamed
 - b) phony
 - c) tempted
 - d) worried
11. The judge SENTENCED the convicted man.
 - a) gave a pardon to
 - b) gave high praise to
 - c) passed judgement upon
 - d) sympathized with
12. It is useless to attempt to FLEE from every danger. Some risk must be taken.
 - a) hide oneself
 - b) protect oneself
 - c) run away
 - d) stay away

VI. Education



Professor: "Now, John, what are you doing — learning something?"

Student: "No, sir; I am listening to you."

*

The professor rapped on his desk and shouted: "Gentlemen — order!"

The entire class yelled: "Beer!"

86. PUPILS. *Choose the correct answer.*

1. The children can get to school ten minutes earlier if they take a short through the park.
a) cut b) link c) pass d) path
2. When Mr Obsequious was at school, he won first for good behaviour.
a) present b) price c) prize d) reward
3. This is an exciting book which new ground in educational research.
a) breaks b) reaches c) scratches d) turns
4. Little Tom did not like his first at school at all.
a) course b) period c) presence d) term
5. We all laughed at his of the teacher.
a) copy b) image c) imitation d) mimic
6. They had lunch together in the school
a) bar b) café c) canteen d) restaurant
7. You could all the worthwhile information in this article into one page.
a) condense b) contract c) decrease d) shorten
8. Sue's teacher her to improve her drawing.
a) encouraged b) insisted c) made d) persisted
9. We all make mistakes; no-one is
a) fallible b) infallible c) mistaken d) unmistakable
10. It's your that we're late for school again.
a) care b) fault c) mistake d) trouble
11. I think you should that matter with your teacher.
a) complain b) demand c) discuss d) enquire
12. Since Oscar had no proper reason for missing school, his absence should be treated as
a) abstention b) desertion c) neglect d) truancy
13. If pupils are to understand the notice, the instructions must be clearer.
a) done b) got c) made d) wrote
14. You are late again — please try to be in future.
a) accurate b) efficient c) punctual d) reliable
15. An I. Q. test is supposed to measure the of your intelligence.
a) degree b) extent c) level d) size
16. You are not very today, Hugh. What's the matter? I've never known you so quiet.
a) chattering b) loud c) speaking d) talkative
17. Those pupils never any notice of what their teacher says.
a) attend b) give c) make d) take
18. Annie is already twelve but she hasn't learned to the time yet.
a) know b) read c) say d) tell
19. Patrick the whole morning looking for his essay, but still couldn't find it.
a) brought b) had c) passed d) spent

20. Rita is not of doing this work — she should change her class.
a) capable b) fit c) possible d) suitable
21. After he broke the window, the boy was from school.
a) exiled b) excluded c) expelled d) extracted
22. A child's first five years are the most important as far as learning is
a) affected b) concerned c) hit d) touched
23. It takes a great deal of for the class to make a trip abroad.
a) arrangement b) business c) expense d) organisation
24. There is no in going to school if you're not willing to learn.
a) aim b) point c) purpose d) reason
25. There are three of us and there is only one book so we'll have to it.
a) distribute b) divide c) share d) split

87. ENROLMENT. *Choose the right answer.*

1. New students must for classes before term begins.
a) enrol b) enter c) join d) teach
2. Quentin must go to France for the next of his training.
a) point b) stage c) stand d) step
3. Medical students are doctors
a) for the most part b) in the making c) in the mind's eye d) to the life
4. I'm going to all I can about the subject because I need this information.
a) discover b) find out c) know d) realise
5. This course no previous knowledge of the subject.
a) assembles b) assigns c) assumes d) assures
6. Sean asked his teacher's about going to university.
a) advice b) experience c) information d) knowledge
7. What are you going to do when you school?
a) complete b) conclude c) end d) leave
8. Have you for any evening classes next term?
a) engaged b) enrolled c) inscribed d) signed
9. Viola took her at Cambridge University.
a) degree b) grade c) qualification d) standard
10. In some countries, students are selected to their current level of academic attainment.
a) according b) due c) owing d) relating
11. Your progress will be in three months' time.
a) counted b) enumerated c) evaluated d) priced
12. Vivian is studying to become a member of the medical
a) employment b) position c) post d) profession

13. Our group of twelve students.
a) composes b) comprises c) consists d) contains
14. The new experimental system of enrolment didn't expectations.
a) climb up to b) come up to c) reach d) rise to
15. Some schools have very rules of behaviour which must be obeyed.
a) solid b) straight c) strict d) strong
16. It was very difficult for the examiner to what recommendations he should make.
a) decide b) realise c) settle d) solve
17. Please inform the college secretary if you your address.
a) change b) move c) remove d) vary
18. Sharon wants to make it clear that she prefers a course in Fine Arts as from Graphic Arts.
a) different b) discrete c) distinct d) separate
19. The classes were closed because of of interest.
a) absence b) emptiness c) lack d) missing
20. This school has the highest standards in our town.
a) academic b) intelligence c) learning d) study
21. Please find a copy of the letter I received from the college.
a) contained b) covered c) enclosed d) included
22. We need information before we can decide which courses to choose.
a) farther b) further c) near d) nearer
23. Someone from the Ministry of Education is coming to our classes.
a) control b) inspect c) look on d) overlook
24. Before joining a course of study you must fill in a long form.
a) enrolment b) induction c) inscription d) personal
25. Please clearly which courses you want to take.
a) ask b) indicate c) instruct d) learn

* 88. ENROLMENT Put each of the following words or phrases into its correct place in the passage below.

amount	calendar	class hours	college	selecting
course	credits	curriculum	electives	
graduation	major	number	opportunity	
outlines	prospectus	specified	subjects	
requirements	technical	three	week	

Selecting Courses

The courses given by a or university are called its curriculum. The of the institution the complete It gives the for entry to each course, as well as the credits given for the

Each course is designated as giving a number of credits. These are usually equal to

the number of devoted each week to the course. For example, a course that meets three times a usually gives credits towards graduation. Schools using the semester require about 120 credits for Between 30 and 40 of the required must be in the student's subject.

Schools vary considerably in the of freedom given students in their courses. Almost all schools have a certain of required Students can also usually choose nonrequired courses called Liberal-arts colleges usually give students more to choose than do schools.

*** 89. ENROLMENT.** *Choose the right answer.*

1. The Examination Board have recently changed the for the Diploma in History.
a) brochure b) compendium c) programme d) syllabus
2. It should be that students are expected to attend classes regularly.
a) marked b) noted c) perceived d) reminded
3. The Headmaster is preparing the for next term.
a) brochure b) catalogue c) pamphlet d) timetable
4. During their first teacher-training year, the students often visit local schools to lessons.
a) examine b) inspect c) investigate d) observe
5. The school is worn on the boys' caps.
a) badge b) figure c) label d) sign
6. Mr Wellbred went to a school which good manners and self-discipline.
a) blossomed b) cultivated c) harvested d) planted
7. There was a(n) against the College's new syllabuses.
a) bang b) outcry c) scream d) whistle
8. The tutorial system at Oxford and Cambridge is the of many universities.
a) envy b) jealousy c) regret d) sorrow
9. Miss Undecided was not sure which profession to enter, but finally for medicine.
a) accepted b) chose c) opted d) selected
10. Comprehensive schools for all levels of ability.
a) cater b) cope c) look d) watch
11. Secondary schools offer a wide of subjects.
a) field b) list c) range d) type
12. If you want to attend a course, you should study the college for full particulars of enrolment.
a) programme b) prospects c) prospectus d) syllabus

90. LECTURES. Choose the right answer.

1. Are you going to attend Prof. Wise's on Medieval History next week?
a) conference b) discussion c) lecture d) meeting
2. The lecture was so that almost everyone fell asleep.
a) bored b) dull c) exhausted d) tired
3. According to my , the lecture starts at eleven tomorrow morning.
a) belief b) information c) knowledge d) opinion
4. Prof. Rush was speaking so quickly I couldn't what he said.
a) accept b) catch c) listen d) take
5. Use your imagination and try to the scene in your mind.
a) draw b) model c) paint d) picture
6. Miss Not-Very-Bright said she could not all the information given in the lecture.
a) absorb b) accumulate c) admire d) listen
7. When you listen to a lecture, it is useful to the important points.
a) clear b) notify c) put down d) write on
8. I can agree with you to a certain , Professor, but not entirely.
a) extent b) level c) part d) way
9. The lecture was very and I slept for most of it.
a) annoying b) boring c) noisy d) sleepy
10. You ought to pay to what the lecturer is saying; it's quite interesting.
a) attention b) comment c) importance d) praise
11. Dr Knowledgeable will be making a this evening.
a) lecture b) sermon c) speech d) talk
12. I absolutely with everything that has been said.
a) accept b) admit c) agree d) approve
13. You will never understand my arguments if you don't actually to what I say!
a) appreciate b) hear c) listen d) understand
14. The students paid attention to their distinguished professor.
a) respectable b) respected c) respectful d) respective
15. The lecture will begin at 10.00
a) in time b) on time c) punctual d) sharp

*** 91. LECTURES. Choose the right answer.**

1. Would you please from smoking while the lecture is in progress?
a) avoid b) keep yourself c) refrain d) stop
2. Prof. Orator spoke clearly and so we could understand every word he said.
a) distinct b) distinctly c) distinguishable d) legibly

3. During a lecture I always try to down the main points that are made.
a) doodle b) jot c) noting d) sketch
4. That's precisely what I mean. You've hit the on the head.
a) idea b) nail c) pin d) point
5. The students were interested in what the teacher was saying and listened
a) attentively b) guardedly c) prudently d) watchful
6. A few jokes always up a lecture.
a) inspire b) liven c) loosen d) raise
7. Miss Duffer looked as if she hadn't a what Prof. Sophisticated was talking about.
a) clue b) guess c) point d) thought
8. You can your shorthand by taking notes during lectures.
a) keep b) keep in c) keep on d) keep up
9. To begin the lecture, let's take an of the present situation.
a) oversight b) overtone c) overture d) overview
10. The lecturer spoke so fast that I found it hard to take what he was saying.
a) away b) in c) over d) up
11. Prof. Silvertongue was a most effective speaker and his audience seemed to on his every word.
a) catch b) cling c) hang d) hold
12. I'm relying on you, gentlemen, so please don't
a) allow me off b) drop me off c) drop me down d) let me down
13. The teacher out the words he had written on the blackboard.
a) cleaned b) dusted c) rubbed d) scraped
14. The example you have just referred to has no on the matter under discussion.
a) bearing b) connection c) dependence d) relation
15. I'm afraid my speech may have you as to my true aims.
a) miscalculated b) misled c) mistaken d) misunderstood
16. Please repeat what you said. I didn't quite the meaning.
a) comprehend b) grasp c) retain d) seize
17. I take to that remark. It's a quite unjustified insinuation.
a) affront b) displeasure c) exception d) offence
18. The professor never finished his lecture because there were so many from the audience.
a) delays b) gaps c) interruptions d) intervals

92. HOMEWORK. *Choose the right answer.*

1. There is a(n) at the back of the book giving the answers to the exercises.
a) appendix b) index c) key d) reference
2. No one helped Tracy to do her homework; she did it
a) all by herself b) by all herself c) by herself all d) herself all

3. Clare was her homework when her boyfriend called.
a) at the centre b) halfway through c) in between d) in the middle
4. That work is needed by next Thursday, so make sure you keep to the
a) dead end b) deadline c) deadlock d) dead stop
5. What did you get for your French composition?
a) figure b) mark c) number d) sign
6. Can you recite the Russian alphabet ?
a) around b) backwards c) reverse d) upside down
7. the regular written work, you will be required to submit a long essay.
a) Apart from b) Beyond c) Beside d) In addition
8. I can't find any logical between these two sentences.
a) bond b) chain c) link d) tie
9. For tomorrow, I'd like you to read pages 25 to 38
a) excluded b) exclusive c) included d) inclusive
10. My brother found it difficult to learn to write because he is
a) left-handed b) right-handed c) single-handed d) two-handed
11. Suddenly I understood perfectly and everything fell place.
a) down b) for c) into d) out
12. Judging by the Sean has put into his essay, he should do well.
a) exercise b) effort c) labour d) toil
13. In writing the account of his summer adventures, Neville chose not to his experiences in the order in which they happened.
a) arrange b) classify c) compare d) compose
14. I must know where these quotations Please indicate their source.
a) began b) come from c) invent d) start
15. If you want to learn you will, no who teaches you.
a) consideration b) matter c) question d) way
16. Will you this essay, please, and see if I have made any mistakes?
a) look through b) look up c) see through d) see to
17. My teacher never my mistakes to me.
a) explains b) exposes c) marks d) reveals
18. There are a lot of mistakes in your homework, I'll have to it again with you.
a) come through b) go over c) instruct d) pass
19. When I was at school we had to learn a poem every fortnight.
a) by ear b) by eye c) by heart d) by mouth
20. I can't make anything his writing.
a) from b) in c) of d) out
21. The instructor me what my mistake was.
a) clarified b) demonstrated c) explained d) showed
22. It's no good me of giving the wrong answer!
a) accusing b) blaming c) criticising d) scolding

23. Isn't it time you started your homework, Gilbert?
 a) about b) good c) past d) the
24. I have been working since this morning, and I am absolutely
 a) destroyed b) down c) exhausted d) tired
25. Turn the book round, you've got it
 a) downside up b) inside out c) upside-down d) outside in

*** 93. HOMEWORK.** *Choose the right answer.*

1. It's vital that the students' handwriting be
 a) illiterate b) legible c) legitimate d) literate
2. It's quite which question you answer first because you must answer them all.
 a) arbitrary b) indifferent c) unconditional d) voluntary
3. Vincent read the article through quickly, so as to get the of it before settling down to a thorough study.
 a) core b) detail c) gist d) run
4. It is very difficult to the exact meaning of an idiom in a foreign language.
 a) convert b) convey c) exchange d) transfer
5. I tried to concentrate on my homework but my eyes kept away from the handbook.
 a) digressing b) lapsing c) rambling d) straying
6. On Sunday, Vivian studied for seven hours
 a) at length b) at once c) in full d) on end
7. Miss Nervous handed in the test and awaited the results
 a) in the same breath b) out of breath c) under her breath d) with bated breath
8. Wilfred was so in his studies that he did not notice the time passing.
 a) drenched b) drowned c) engrossed d) soaked
9. You will need a pen and some paper to this problem. It is too difficult to do in your head.
 a) discover b) find out c) realise d) work out
10. Students will be for exceeding word-limits in their precis.
 a) condemned b) penalised c) punished d) sentenced
11. I'm afraid I've only had time to the article you recommended.
 a) glance b) look c) peruse d) scan
12. Frank has a good for figures.
 a) brain b) head c) mind d) thought
13. The noise from the traffic outside me from my homework.
 a) annoyed b) distracted c) prevented d) upset
14. You must not from the point when you write an essay.
 a) diverge b) go astray c) ramble d) wander

15. I can't possibly mark your homework as your handwriting is
 a) illegible b) illicit c) illogical d) illusive
16. Deborah is going to take extra lessons to what she missed while she was away.
 a) catch up on b) cut down on c) put up with d) take up with
17. Miss Crammer is so in her work that it would be a pity to disturb her.
 a) absorbed b) attentive c) consumed d) intent
18. It suddenly on me what he really meant.
 a) came b) dawned c) hit d) struck

94. STUDENTS. *Choose the correct answer.*

1. How many is Sam studying at school?
 a) objects b) subjects c) themes d) topics
2. I have English classes day — on Mondays, Wednesdays and Fridays.
 a) all other b) each other c) every other d) this and the other
3. I haven't had a very week. I seem to have done nothing at all.
 a) economic b) enthusiastic c) extensive d) productive
4. It is impossible to find a good educational computer program.
 a) almost b) barely c) hardly d) merely
5. . . . the difficulty of the task, I shall be lucky to complete it by the end of next month.
 a) Accepted b) Given c) Presuming d) Regarding
6. A small of students was waiting outside the classroom to see the teacher.
 a) form b) gang c) group d) team
7. Hard as she tried, she couldn't understand the question.
 a) always b) even c) still d) yet
8. And as she didn't understand anything, she merely gave the teacher a look.
 a) blank b) clear c) simple d) useless
9. How many marks did you in the last test?
 a) get b) make c) score d) take
10. You will have to do the course again because your work has been
 a) unnecessary b) unpleasant c) unsatisfactory d) unusual
11. Andy was from school because of his bad behaviour.
 a) evicted b) expelled c) left d) resigned
12. I'm not sure why he didn't go to the college, but I he failed the entrance test.
 a) deduce b) estimate c) predict d) suspect
13. The study of can be very interesting.
 a) a history b) histories c) history d) the history
14. You can learn as much theory as you like, but you only master a skill by it.
 a) doing b) exercising c) practising d) training

15. Mabel's school report last term was most
a) fortunate b) fulfilling c) satisfactory d) satisfied
16. Most of the students agreed to the plan, but a few it.
a) argued b) differed c) failed d) opposed
17. Mr Genius was so at maths at school that he became the youngest student ever to be accepted by a college.
a) brilliant b) hopeful c) keen d) proud
18. Miss Lazy has hardly done any this week!
a) effort b) job c) labour d) work
19. When I told him my opinion, he his head in disagreement.
a) hooked b) knocked c) rocked d) shook
20. Please reply as I have no time to lose.
a) hastily b) promptly c) rapid d) swift

95. STUDENTS. Put each of the following words into its correct place in the passage below.

authority	bachelor's	bodies	campuses
classes	co-educational	co-ordinate	courses
degree	freshmen	graduates	junior
located	school	separate	sex
special	students	undergraduates	university
women	year		

Students

The student body of a or college is divided into and undergraduates. Graduates have already received their degrees, while have not. The undergraduates belong to one of four, according to their of study. These are, sophomore,, and senior classes. Most schools also admit students who take a number of, but are not working towards a

Students vary considerably from to school. Some institutions are, with both men and students. Others admit of only one

A institution has men's and women's colleges. They are controlled by the same central and are usually on the same campus or nearby

*** 96. STUDENTS.** Choose the correct answer.

1. Miss Pretender's knowledge of the subject was only
a) external b) outer c) outward d) superficial
2. Arnold is a bit with his English classes so his parents have arranged for him to have private tuition.
a) dragging b) fighting c) straining d) struggling

3. Billy is a most young man; he can do a lot of different jobs well.
a) capable b) cunning c) industrious d) laborious
4. Miss Conceited is very up and thinks she is superior to her classmates.
a) fed b) looked c) stuck d) turned
5. The new student found the informality at school at first.
a) blinding b) foreign c) mysterious d) off-putting
6. We can't teach him anything because he already knows his subject
a) from cover to cover b) from top to toe c) inside out d) upside-down
7. What's done is done. It's wondering what would have happened if you had passed the exam.
a) futile b) helpless c) ineffectual d) valueless
8. My sister is a most student, never failing to turn up to lectures.
a) absent b) careful c) conscientious d) honest
9. You completely misunderstood my instructions; you got hold of the wrong end of the
a) line b) rope c) stick d) story
10. Miss Amusing was at school because she always made people laugh.
a) attractive b) considerate c) familiar d) popular
11. Some people have the mistaken idea that all students are
a) idle b) motionless c) stagnant d) still
12. After the serious talk with his tutor, Hilary himself more conscientiously to his studies.
a) applied b) converted c) engaged d) exerted

97. TEACHERS AND STUDENTS. Match the words for people in education with the correct definition.

- | | |
|-----------------|--|
| 1. apprentice | a) female teacher in charge of a school |
| 2. cadet | b) person who trains sportsmen for contests or prepares private students for an exam |
| 3. coach | c) highest grade of university teacher |
| 4. dean | d) the lowest teaching rank at a university |
| 5. disciple | e) person in charge of a division of study |
| 6. headmistress | f) person who teaches you driving |
| 7. instructor | g) the head of some universities and schools |
| 8. lecturer | h) a person studying to become an officer in the army or a policeman |
| 9. trainee | i) someone learning a trade who works in return for being taught |
| 10. principal | j) person undergoing some form of vocational training |
| 11. professor | k) anyone devoted to the acquisition of knowledge, especially attending university |
| 12. pupil | l) attends primary school |
| 13. student | m) follower of a religious teacher |

98. TEACHERS. *Choose the correct answer.*

1. The class teacher punished disobedient pupils
a) hardly b) severely c) stiffly d) strongly
2. It was a great to study under such an outstanding teacher.
a) favour b) fortune c) privilege d) value
3. We all like Prof. Merryman because of his great of humour.
a) feeling b) principle c) sense d) willingness
4. The most important that Dr Projector was responsible for was the use of video in teaching.
a) innovation b) introduction c) novelty d) reformation
5. My English teacher me to try for a place in the English Department at the Jagiellonian University.
a) convinced b) encouraged c) insisted d) proposed
6. Mr Violin has been teaching music for years, even though he hasn't got any
a) examinations b) experience c) experiment d) qualifications
7. Mr Unemployed went to Algeria hoping to find a teaching without too much difficulty.
a) employment b) job c) occupation d) work
8. A university professor's view is rarely that of the man in the
a) bus b) factory c) queue d) street
9. Dr Scholar uses student volunteers as for his experiments.
a) agents b) cases c) models d) subjects
10. You must ask your class teacher to do that.
a) agreement b) allowance c) permission d) permit
11. your hand if you want to ask a question in class.
a) Arise b) Lift c) Raise d) Rise
12. For goodness' stop asking such silly questions!
a) benefit b) like c) love d) sake

99. TEACHERS. *Use each verb, at least once, in the correct form to complete the following.*

guide instruct learn lecture teach train

1. Animals are often by their instinct as to what is the right thing to do in a difficult situation.
2. German shepherd dogs are sometimes to the blind.
3. Prof. Wise on British history twice a week. He has already us a lot. We from him how to read and evaluate original documents.
4. Mr Needle a class of apprentices in sewing. He apprentices about types of cloth and they are to cut out and sew garments.

* 100. **TEACHERS.** *Choose the correct answer.*

1. At the beginning of the school year, every teacher is a classroom.
a) allocated b) distributed c) registered d) sorted
2. Could you stand for me and teach my history class tomorrow, Maggie?
a) down b) in c) out d) up
3. The teaching profession offers good career for the well-qualified teacher.
a) ladders b) perspectives c) prospects d) scales
4. Mr Optimist has been looking for a school with a attitude towards its students and their work.
a) hard b) heavy c) grave d) serious
5. I wonder whether the lecturer will be up to the questions such an audience is capable of.
a) cutting b) examining c) piercing d) searching
6. Prof. Pedant announced that he was addressing the meeting in his as a teacher.
a) capacity b) character c) qualification d) rank
7. Teachers have learned to take shortages of textbooks and equipment in their
a) course b) habit c) scope d) stride
8. Some people are against informality at lectures but, personally, I the idea.
a) applaud b) cheer c) clap d) shout
9. My mother had to take private pupils in order to her salary as a teacher.
a) augment b) expand c) complete d) inflate
10. Mr Horrid was a terrible teacher and obviously not for teaching.
a) cut in b) cut on c) cut out d) cut up
11. Mr Original some unusual educational beliefs.
a) carries b) holds c) keeps d) takes
12. Our maths teacher applied for a year's leave to write his Ph. D. dissertation.
a) sabbatical b) satanic c) superfluous d) suspended

** 101. **TEACHERS AND STUDIES.** *Which of the three definitions most nearly describes each of the following subjects?*

1. Agronomy, taught by agronomists, is
a) the study of primitive races
b) the survey of human emotions
c) the science of farming
2. Anthropology, taught by anthropologists, is
a) the science of ants
b) the study of man
c) the art of poetry

3. Embryology, taught by embryologists, is
 - a) the study of coals
 - b) the study of the development of living creatures before their birth
 - c) the study of amber
4. Entomology, taught by entomologists, is
 - a) the study of insects
 - b) the study of the derivation of words
 - c) the study of tombs and monuments
5. Graphology, taught by graphologists, is
 - a) the analysis of handwriting
 - b) the study of the earth
 - c) the study of maps
6. Linguistics, taught by linguists, is
 - a) the science of language
 - b) the study of linking chains together
 - c) branch of mathematics dealing with lines
7. Penology, taught by penologists, is
 - a) the art of good penmanship
 - b) the study of old-age pensioners
 - c) the study of prison management
8. Philology, taught by philologists, is
 - a) the art of wisdom
 - b) literary scholarship
 - c) the study of the derivation of words
9. Physiology, taught by physiologists, is
 - a) the study of the functions of the body
 - b) the study of the functions of the mind
 - c) the science of matter and energy
10. Seismology, taught by seismologists, is
 - a) the splitting of the atom
 - b) the science of earthquakes
 - c) the study of famous quotations
11. Theology, taught by theologians, is
 - a) the study of religion
 - b) the art of the theatre
 - c) the study of wind
12. Typography, taught by typographers, is
 - a) the making of maps
 - b) the art of printing
 - c) the study of human types

**** 102. TEACHERS AND SUBJECTS.** *Fill in the missing information.*

SUBJECT	TEACHER	IS THE STUDY OF
geology
t	religion
.....	botanist
a	ancient ruins
.....	entomologist
agronomy
b	life
zoology
.....	meteorologist
e	words
e	unborn babies
.....	graphologist

103. EXAMINATIONS. *Choose the correct answer.*

- Remember that exams never start late, they always start
a) ahead of time b) at the last moment c) in time d) on time
- Will you help me to for tomorrow's exam?
a) go through b) read c) review d) revise
- Lazy Tom clearly had no of doing any work, although it was only a week till the exam.
a) ambition b) desire c) intention d) willingness
- Are the students about the history exam?
a) discussing b) saying c) talking d) telling
- If you never do any work, you will only have yourself to if you fail your exams.
a) blame b) fault c) mistake d) reprove
- I'm I didn't pass the exam but I'll do better next time.
a) deceived b) despaired c) disappointed d) disillusioned
- You must tell me the result now. I can't bear the
a) suspenders b) suspending c) suspense d) suspension
- As my exam is next month, I'll take advantage of the week off to on some reading.
a) catch up b) hurry up c) make up d) pick up
- Eve was happy she to finish the exam in time.
a) achieved b) managed c) realised d) succeeded
- Do you think there is any of him passing the exam?
a) chance b) expectancy c) occasion d) opportunity

11. I hate formal examinations. I find it difficult to organise my thoughts in a limited space of time.
a) making b) passing c) sitting d) writing
12. Don't forget to your name at the top of the testpaper.
a) get b) place c) put d) set
13. Your answers to the examination questions must exactly the instructions given below.
a) accompany b) conform c) follow d) keep
14. Eric was very upset by his French exam
a) effects b) failures c) results d) successes
15. Well done! You've done an excellent
a) job b) task c) trade d) work
16. If at first you don't , try again.
a) accomplish b) prosper c) succeed d) triumph
17. Those students their exams last week.
a) assisted b) made c) presented d) took
18. Franky got very marks in his maths exam.
a) imperfect b) low c) reduced d) secondary
19. Did you the examination last month?
a) enter into b) form part of c) go in for d) take place in
20. You should write your name at the top of the paper.
a) clearly b) largely c) obviously d) seriously
21. Good! I hope you do well.
a) chance b) hope c) luck d) wish
22. The examiners often extremely difficult questions for the written exams.
a) create b) make c) set d) write
23. I expect all of you to be here ten minutes before the examination begins, without
a) fail b) failure c) fault d) miss
24. The purpose of this examination was to the students' knowledge of the subject.
a) inspect b) prove c) test d) try
25. Vivian passed the test but failed the written examination.
a) handy b) practical c) skilful d) working

104. EXAMINATION GRADING. Put each of the following words into its correct place in the text.

achievements	adjustment	admit	attitude
average	colleges	common	failure
grade	letter	marking	method
minimum	occasionally	pass	percentage
perfect	progress	record	reports
school	teacher		

Grading

Grading is a used in schools to student achievements. Almost every keeps a record of each student's in order to have some basis for measuring his The record supplies information for to parents. Universities and often use this information to help determine whether they should a student.

For a long time, the most method of recording achievement was by, with a mark, or, of 100 per cent representing achievement. The mark for a was usually 70 per cent, and for work, about 80 per cent. Today, the letters A, B, C, D, E, and F, are much more commonly used. The mark A stands for exceptional achievement, and E or F means

A few schools use no system at all. Instead, each writes a detailed to the parents. Such letters report the student's progress,, activities, and social

105. EXAMINATIONS. Choose the correct answer.

- Miss Unlucky was very because she had failed her examination.
a) afraid b) excited c) sensitive d) upset
- You should have the examination last week, so bring your money to the office as soon as possible.
a) entered for b) passed c) sat for d) taken
- Congratulations passing your exams. Well done!
a) by b) for c) from d) on
- During the test it is always better to make an educated than to leave a blank.
a) attempt b) chance c) endeavour d) guess
- Mrs Worried had a good of the examination result when she saw her daughter's face.
a) idea b) news c) report d) thought
- This kind of question can sometimes be answered only by a process of
a) abolition b) elimination c) exception d) subtraction
- The person who an examination is supposed to see that nobody tries to cheat.
a) dominates b) governs c) leads d) supervises
- Greg has just taken an exam history.
a) about b) for c) in d) on
- Miss Intelligent was the student in her class and passed all her exams with high grades.
a) brightest b) clearest c) fastest d) highest
- Sign your name on the line.
a) broken b) dotted c) drawn d) spotted
- There must be a of at least one metre between the desks in the examination room.
a) expanse b) gap c) place d) room
- This test a number of multiple-choice questions.
a) composes of b) composes in c) consists of d) consists in

13. Please don't talk in the because there is an examination in the lecture hall.
a) corridor b) lane c) promenade d) way
14. The thought of exams makes me feel ill.
a) just b) little c) mere d) sole
15. The school has a system of monthly tests in place of an annual exam.
a) adopted b) agreed c) collected d) taken

*** 106. EXAMINATIONS.** *Choose the correct answer.*

1. Miss Diligent did nine hours' studying a day for her exam.
a) big b) heavy c) powerful d) solid
2. In the examination you may be asked for comments on various of a topic.
a) angles b) aspects c) features d) qualities
3. Failing the final exam was a big to my hopes.
a) band b) blow c) hit d) kick
4. You shouldn't talk about him failing. You'll his confidence.
a) underestimate b) undergo c) undermine d) worry
5. I'm feeling rather because of the exam I'm doing next week.
a) anxious b) excited c) impatient d) unquiet
6. The result of this exam will his future.
a) control b) determine c) govern d) rule
7. Please be I haven't got long.
a) brief b) concise c) rapid d) short
8. George has no head for figures. He simply cannot them.
a) collect b) realise c) relate d) remember
9. No one is so as the person who has no wish to learn.
a) ignorant b) sensible c) simple d) useless
10. In a multiple-choice exercise it's sometimes easier to the wrong answers before choosing the right one.
a) eliminate b) exclude c) give d) omit
11. Waiting outside the examination room, I trembled with
a) apprehension b) comprehension c) expectation d) tension
12. His test results are not very He does well one month and badly the next.
a) consequent b) consistent c) continuous d) invariable
13. The exam in March prepared pupils for the real thing in May.
a) false b) imaginary c) mock d) unreal
14. My hopes of becoming a doctor when I failed my "A" levels.
a) cracked b) crashed c) crumbled d) smashed
15. I was completely by most of the exam questions, so I must have failed.
a) baffled b) harassed c) stupid d) stupified
16. Having already graduated from another university, he was from the entrance examination.
a) deferred b) excluded c) exempted d) prohibited

17. This exam is supposed to be because the marking is not affected by individual preferences.
 a) concrete b) impersonal c) objective d) open-minded
18. Any candidate caught in the examination will be disqualified.
 a) cheating b) deceiving c) swindling d) tricking

107. LANGUAGE-LEARNING. Choose the right answer.

1. The new school claims to students all the English they need in a few months.
 a) explain b) instruct c) learn d) teach
2. I never a chance of improving my English if I can help it.
 a) avoid b) lose c) miss d) waste
3. Will you me how to make that sound?
 a) learn b) practice c) show d) train
4. Franek thought that the other students would think he was English, but his accent gave him
 a) away b) in c) out d) up
5. that he only started learning it one year ago, his English is excellent.
 a) Accounting b) Considering c) Imagining d) Wondering
6. We were the students in the class who could speak Russian.
 a) alone b) one c) only d) single
7. Your pronunciation would improve if you with a tape recorder.
 a) exercised b) practised c) repeated d) trained
8. The students ever use the language laboratory.
 a) almost b) hardly c) nearly d) practically
9. Priscilla asked for lessons at home as she thought she would learn English more quickly that way.
 a) particular b) peculiar c) personal d) private
10. Learners of English as a foreign language often fail to between unfamiliar sounds in that language.
 a) differ b) distinguish c) separate d) solve
11. Jonathan was surprised that Sonia's English was so as she had never been to England.
 a) definite b) fluent c) liquid d) national
12. If you want to learn a new language you must classes regularly.
 a) assist b) attend c) follow d) present
13. Would you to me studying English privately?
 a) allow b) agree c) approve d) permit
14. Spanish is the language of most Spaniards.
 a) home b) mother c) native d) nature

15. They are learning English, but they haven't much progress.
a) done b) got c) made d) performed
16. There has been a great in his English.
a) escalation b) improvement c) increase d) rise
17. If you don't know what that word means, in the dictionary.
a) give it up b) look it up c) make it up d) show it up
18. Some language students reach a high of competence in communication.
a) degree b) grade b) level c) mark d) note
19. Don't to correct me if I make a mistake.
a) hesitate b) mind c) pause d) stop
20. Please your hand if you want to ask a question.
a) arouse b) put out c) raise d) rise
21. At the language school, each student is assigned to his or her own
a) director b) professor c) staff d) tutor
22. A(n) mistake which many students make is to leave out the definite article.
a) common b) just c) ordinary d) plain

* 108. LANGUAGE-LEARNING. *Choose the correct answer.*

1. Mario has now to the point where his English is almost fluent.
a) advanced b) approached c) arrived d) reached
2. Pierre's of the basic structures is good but his vocabulary is limited.
a) grasp b) grip c) hold d) seizure
3. Some people think it is to use long and little-known words.
a) clever b) intentional c) sensitive d) skilled
4. There is a feature of dialect to Bristol by which an "r" is added to the ends of ~~some~~ words.
a) original b) particular c) peculiar d) proper
5. A role-play session is particularly useful in bringing together different of teaching.
a) cords b) fibres c) strands d) threads
6. Cyril's understanding of the language is growing
a) by hook or by crook b) by leaps and bounds c) from time to time d) slow but sure
7. It's fifteen years since Timothy worked in Holland and his Dutch is pretty now
a) rusty b) scratchy c) sloppy d) stale
8. The school's exam results the headmaster.
a) celebrated b) delighted c) enjoyed d) rejoiced
9. The Examination Syndicate was most impressed by the overseas student whose English was
a) impeccable b) infallible c) irreproachable d) spotless
10. It is that students will have doubled their vocabulary in three months.
a) anticipated b) foreseen c) hope d) worry

109. LANGUAGE-LEARNING. *Crossword.*

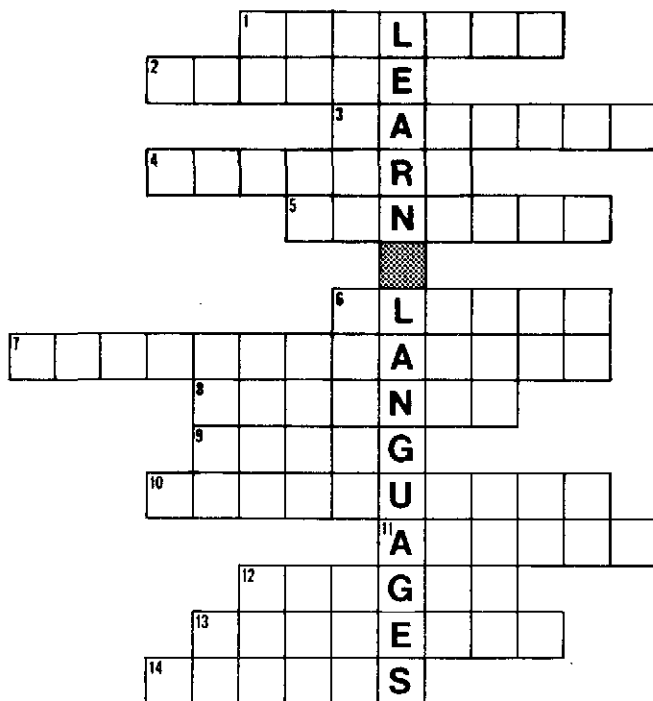

1. a variety of a language, spoken in one part of a country, different in some words or pronunciation from other forms of the same language (7)
2. a language; "Spanish is her mother" (6)
3. telling someone who's done something stupid that he's "absolutely brilliant" (7)
4. "Look before you leap" or "A friend in need is a friend indeed" (7)
5. "wealthy" is a of "rich" (7)
6. expression used so commonly that it has lost much of its expressive force (6)
7. the accent of British English which has become the standard for teaching and learning is known as Received P (13)
8. "pretty" is an of "ugly" (7)
9. informal language used among friends but not suitable for good writing or formal occasions (5)
10. all the words known to a particular person (10)
11. a particular way of speaking, usually connected with a country, area, or class (6)
12. language that is hard to understand, especially because it is full of special words known only to members of a certain group e.g. linguists or schoolboys (6)
13. a group of words that form a statement, command, exclamation, or question, beginning with a capital letter and ending with one of the marks (!/./?) (8)
14. phrases which mean something different from the meanings of their separate words e.g. "make up my mind" (6)

**** 110. PUNCTUATION MARKS.** Match each of the following items with the correct letter near the text below.

abbreviation	apostrophe	asterisk	bracket
capital letter	colon	comma	full stop
hyphen	inverted commas	italics	question mark
small letter	stroke		

- The early records entitled *Calendar* are arranged
- a) chronologically. In some *Calendars* numbered items — h)
 - b) e.g. grants, leases, warrants — appear within a i)
 - c) “calendar” of no uniform duration. Dates are es-
 - d) sential, therefore, in identifying the items*. j)

- * Great Britain. Public Record Office,
- e) *Calendar of State Papers, Domestic, of the Reign* k)
 - f) *of Elizabeth*, vol. 4/1 (1566-69): *Calendar 1566* l)
 - g) (17 November 1566), Elizabeth to Cecil’s Wife (?). m) n)

111. EDUCATION AND MONEY. Choose the right answer.

1. Dr Inventive received a from the university in order to continue his research.
 - a) credit
 - b) grant
 - c) prize
 - d) reward
2. His father paid him while he was at university.
 - a) alimony
 - b) an allowance
 - c) a pension
 - d) the rates
3. The headmaster had been trying to money for a new science block.
 - a) ask
 - b) deal
 - c) increase
 - d) raise
4. Prospective students must show that they have sufficient money to cover their course fees and
 - a) boarding
 - b) maintenance
 - c) supplies
 - d) support
5. If you find it difficult to make ends meet, you can to the university for an additional grant.
 - a) apply
 - b) ask
 - c) propose
 - d) submit
6. Many teachers are protesting about the Government in education.
 - a) contractions
 - b) cuts
 - c) drops
 - d) reductions
7. Students sometimes support themselves by of evening jobs.
 - a) efforts
 - b) means
 - c) methods
 - d) ways
8. The for the course are \$150 a term.
 - a) charges
 - b) costs
 - c) fees
 - d) payments
9. The government will be increasing student to give them more money.
 - a) aids
 - b) benefits
 - c) grants
 - d) rewards
10. Despite the excellent results in his A level exam he has not won a (n) to the university
 - a) aid
 - b) money
 - c) pension
 - d) scholarship

* 112. EDUCATION AND MONEY. Put each of the following words into its correct place in the passage below.

- | | | | |
|---------|---------------|----------|-------------|
| advance | approximately | balance | beginning |
| cash | credit | currency | delayed |
| fees | full | holders | instalments |
| mail | money | payment | Visa |

Payment Plans

Tuition are payable in in full at the time billed. Students may pay by, cheque, order or card (Master Card or). Foreign students must pay in British

..... may be made by telephone for credit card Payment may also be by However, the College is not responsible for lost or mail.

Students who do not pay in in advance automatically choose the deferred payment plan of two equal The initial payment is due two weeks prior to the of each term. The is due four weeks after the beginning of the term.

113. BITS AND PIECES. Give the names of the following bits and pieces.

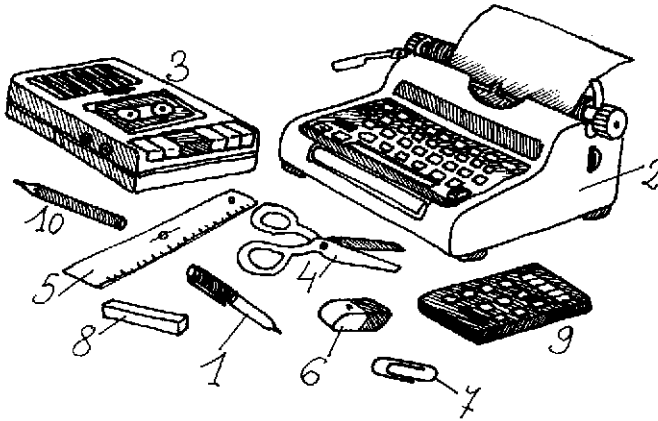

1. _____ pen
2. _____
3. _____ c _____
4. _____
5. r _____

6. r _____
7. p _____ c _____
8. h _____
9. pocket _____
10. _____

114. BITS AND PIECES. Match the names with the bits and pieces.

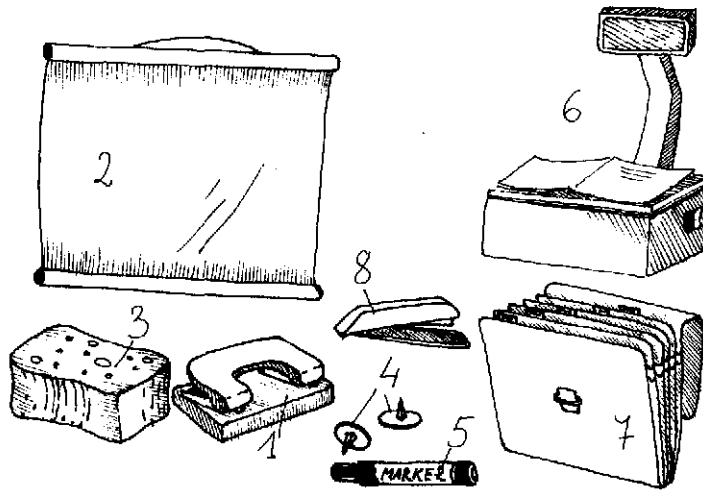

- | | | |
|------------------|------------------------|------------|
| ... board duster | ... drawing pin | ... file |
| ... hole punch | ... stapler | ... screen |
| ... felt-tip pen | ... overhead projector | |

115. BITS AND PIECES. Choose the right answer.

- The needs changing on your typewriter; otherwise we won't be able to read a word.
a) key b) letter c) oil d) ribbon
- The paper was so thin that the of the pencil went right through it.
a) edge b) end c) point d) top
- Write in pencil and out any mistakes.
a) clean b) rub c) scratch d) wipe
- Oh, my pen has ; can you lend me yours? ..
a) run down b) run in c) run off d) run out
- On no must you press this button!
a) account b) circumstances c) reason d) time
- The educational of computers has not yet been fully realised.
a) amount b) quality c) value d) worth
- Can you lend me a of paper?
a) half b) page c) piece d) portion
- He up the sheet of paper and dropped it into the wastepaper basket.
a) bent b) broke c) crumpled d) curled
- With a word you can produce a document much faster than with a typewriter.
a) computer b) copier c) processor d) printer

10. Paper clips, drawing pins and safety-pins were all over the desk.
a) dispersed b) scattered c) separated d) sprayed
11. Give me a of paper and I'll write a message for Mr Absent.
a) blade b) fragment c) leaf d) sheet
12. In the computer room the boys were holes in cards.
a) banging b) knocking c) punching d) shooting
13. We packed most of our books in strong boxes.
a) cardboard b) carton c) paper d) wrapping
14. Unfortunately our local library provides no for photocopying.
a) amenities b) chances c) facilities d) opportunities
15. I can't open the drawer in my desk as it's
a) fixed b) set c) stuck d) unmoved

116. EDUCATION. *Choose the best synonym.*

1. That student is discourteous; he GRUMBLES no matter how you try to please him.
a) complains
b) giggles
c) scolds
d) sneers
2. Vivian REVISED his paper carefully, following the professor's suggestions.
a) copied
b) corrected
c) retyped
d) reviewed
3. "Roget's Thesaurus", a collection of English words and phrases arranged by the ideas they express RATHER THAN in alphabetical order.
a) as well as
b) instead of
c) restricted
d) unless
4. Habits can be CONSCIOUSLY strengthened, as when a student of the guitar practises and memorizes different fingerings.
a) conveniently
b) deliberately
c) lastingly
d) robustly
5. My supply of confidence slowly DWINDLES as the day of the exam approaches.
a) diminishes
b) emerges
c) grows
d) revives

6. His face was **FLUSHED** because he had run all the way from the dorm so as not to be late for the lecture.
 - a) pale
 - b) red
 - c) shaking
 - d) wet
7. The student **BROKE IN ON** the conversation without waiting for the speaker to stop talking.
 - a) interrupted
 - b) regarded
 - c) seized
 - d) withdrew from
8. The warmth of the lecture hall made the student **DOZE**.
 - a) faint
 - b) fall asleep
 - c) sweat profusely
 - d) yawn widely
9. The speaker **DEMONSTRATED** his knowledge of the subject by his excellent lecture.
 - a) corrected
 - b) created
 - c) repeated
 - d) showed
10. The teacher told the student that his paper was **ILLEGIBLE**.
 - a) illegal
 - b) indecipherable
 - c) outstanding
 - d) sloppy

VII. Food, Cooking and Restaurants

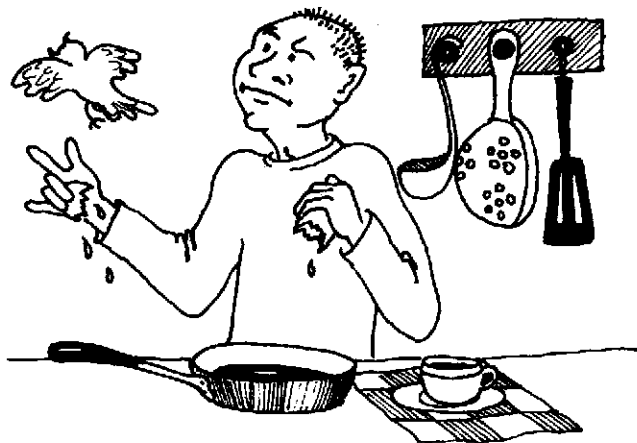

Patron: "Do you serve fish here?"

Waiter: "Certainly, sir. We cater to everyone."

*

Waitress: "We have everything on the menu today, sir."

Customer: "So I see. How about a clean one?"

117. **FOOD.** Put each of the following words into its correct place in the passage below.

animals	bowl	chopsticks	daily
die	energy	Europeans	grow
healthy	knives	left	man
mouth	people	plants	plates
play	spoons		

Food

Food is one of our most important needs. It gives us to work and It makes us grow, and keeps our bodies strong and Without food, we All living things — plants, and man — need food to live and But only make their own food. They also provide food for animals and

Customs influence the ways eat. Most Americans and eat from individual, using, forks, and Arabs use only their hands to spoon foods from a central Chinese and Japanese use to pick up food from a small bowl held close to the

118. **FOOD.** Choose the right answer.

- You shouldn't eat so many sweets; they're for you.
a) bad b) disagreeable c) unhealthy d) unsuitable
- My aunt could tell fortunes from tea
a) buds b) grounds c) leaves d) seeds
- Would you the salt, please?
a) carry b) deliver c) give d) pass
- This avocado rather hard.
a) feels b) senses c) smells d) tastes
- Oranges are said to be for me but I don't much like them.
a) appetising b) good c) healthy d) nourishing
- "What would you like to drink, Miss Delicate, some or something stronger?"
a) brandy b) cider c) sherry d) whisky
- In the jar there was a which looked like jam.
a) material b) powder c) solid d) substance
- Pork chops are one of my favourite
a) bowls b) courses c) dishes d) plates
- These are potatoes, not the end of last season's.
a) fresh b) new c) ripe d) young
- Light were served during the interval.
a) drinks b) foods c) meals d) refreshments
- In Mrs Conservative's, it is essential to eat a big breakfast.
a) confidence b) idea c) opinion d) principle

12. They arrived so late for the meal, that the food was
 a) dried b) hard c) lost d) spoilt
13. I usually white coffee for breakfast.
 a) consume b) eat c) have d) take
14. In England they eat apple with pork.
 a) cream b) custard c) pudding d) sauce
15. A cool drink him after his long hot journey.
 a) recovered b) refreshed c) relaxed d) rested
16. Is this water?
 a) drink b) drinking c) potted d) swallow
17. No thank you, I don't sugar in tea.
 a) drink b) put c) take d) use
18. Would you like me to the tea?
 a) drain b) drip c) pour d) spill

119. FOOD. Put the following eating and drinking verbs into the correct squares.

- | | | | |
|--------|--------|---------|-------|
| bite | chew | crunch | drink |
| eat | gobble | lick | munch |
| nibble | sip | swallow | |

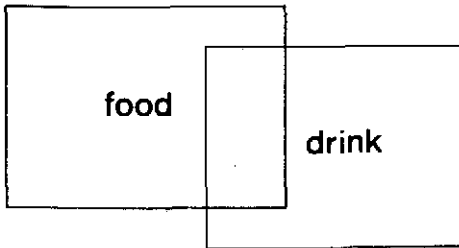

120. FOOD. Choose the right answer.

1. I am very fond of eating onions with cold beef.
 a) frozen b) pickled c) preserved d) salted
2. As the cake was delicious, Mr Sweettooth had a second
 a) amount b) course c) cut d) helping
3. Potatoes are the diet for many European peoples.
 a) bulk b) majority c) staple d) sum
4. "Were you told to get dinner ready?"
 "No, I did it of my own"
 a) accord b) desire c) idea d) will

5. Can't I you to another piece of cake?
a) convince b) persuade c) pull d) tempt
6. "Do you like raw vegetables?"
"Well, it what kind of vegetables."
a) depends b) expects c) matters d) minds
7. The meat is rather tough so you have to it for a long time.
a) bite b) chew c) eat d) swallow
8. Pass me the salad , please.
a) dressing b) sauce c) seasoning d) spice
9. Make sure everyone gets a(n) share of the cake!
a) fair b) just c) own d) same
10. Don't put any cream on my wild strawberries, I prefer them
a) natural b) ordinary c) plain d) simple
11. After the guests had left we were allowed to eat the cakes.
a) additional b) left c) missed d) remaining
12. "I have brought you a cup of tea and a piece of cake, Grannie."
"Thank you. That was of you."
a) brave b) gentle c) nice d) sympathetic
13. Do you think it is possible to on nothing but fruit?
a) eat b) enjoy c) live d) make
14. There is of cake for everyone.
a) enough b) much c) plenty d) some
15. Eating in Poland are changing because of the increasing standard of living.
a) behaviour b) habits c) methods d) ways
16. Mrs Proper always tells her child not to talk with his mouth
a) full b) open c) together d) wide
17. I have been eating honey so my fingers are
a) dirty b) sticky c) wet d) yellow
18. If you saw how they cattle, you would never eat meat again.
a) die b) kill c) murder d) slaughter
19. A good way of food is keeping it in a fridge.
a) enduring b) extending c) preserving d) prolonging
20. It's a Mexican but I can't remember what it is called.
a) especial b) speciality c) specialization d) specializing

**** 121. FOOD.** Match the pictures with the right names of cereal.

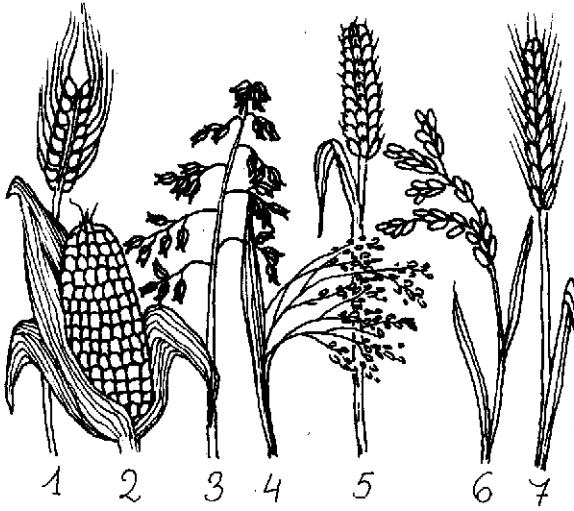

- ... barley ... maize ... millet ... oats
 ... rice ... rye ... wheat

*** 122. FOOD.** Choose the right answer.

1. Mr Connoisseur opened the bottle of wine and let it for one hour.
 a) breathe b) relax c) remain d) sit
2. Mrs Proper told her son it was impolite to his food so greedily.
 a) digest b) gobble c) nibble d) stuff
3. When I entered the room, the children were over the last orange.
 a) consulting b) discussing c) participating d) squabbling
4. How about a glass of orange juice to your thirst?
 a) quash b) quell c) quench d) quieten
5. Although she was trying to slim, Miss Greedy found the icecream with fruit and whipped cream quite
 a) imperative b) inevitable c) irresistible d) pulling
6. Have a of brandy, it will make you feel better.
 a) bite b) sip c) swallow d) touch
7. Peanuts are both cheap and
 a) alimentary b) curative c) nutritious d) remedial
8. Mrs Hospitable had prepared a meal with six courses to celebrate our arrival.
 a) generous b) lavish c) spendshrift d) profuse
9. Mr Fatty wants to slim, so he should avoid eating foods such as bread or potatoes.
 a) fatty b) greasy c) spicy d) starchy

10. My parents have a arrangement to meet for dinner once a fortnight.
 a) deep-seated b) durable c) long-standing d) usually
11. Many Asian countries still rely on rice as the food.
 a) capital b) staple c) superior d) winning
12. The sight of so many sweets made the children's mouth
 a) drip b) moisten c) water d) wet
13. "Another cup of coffee?"
 "No, but thanks"
 a) all the same b) for all c) not at all d) you for all
14. I inferred his remark that Mrs Vegetarian doesn't eat meat.
 a) from b) of c) to d) with

**** 123. FOOD.** Group the words below under the following headings.

1. Cereals
2. Dairy products
3. Fish
4. Fruit
5. Herbs
6. Meat
7. Vegetables

aubergine	bacon	blackberry	beans
barley	basil	chicken	cream
dill	flour	gooseberry	grape
herring	lamb	maize	mint
mustard	mutton	onions	parsley
pear	peas	plaice	rabbit
rice	rye	sage	salmon
sausage	sole	thyme	trout
veal	wheat	yoghurt	

124. FOOD-TASTE. Choose the right answer.

1. What are you cooking? It good.
 a) feels b) flavours c) smells d) sniffs
2. The dish had a very interesting taste as it was with lemon.
 a) flavoured b) pickled c) seasoned d) spiced
3. Can you tell the between Coca-Cola and Pepsi-Cola?
 a) alteration b) change c) difference d) variety
4. The apple was so that he put some sugar on it.
 a) bad b) juicy c) ripe d) sour

5. Snake meat tastes to chicken.
a) alike b) equal c) like d) similar
6. The local wine is rather rough, but you'll soon a taste for it.
a) accept b) adopt c) develop d) receive
7. It tasted so of mint that the other flavours were lost.
a) forcefully b) fully c) hardly d) strongly
8. The apples had become so that we had to throw them away.
a) overripe b) poisonous c) rotten d) green
9. That milk smells
a) acid b) bitter c) sharp d) sour
10. The sauce would be more if you had put more garlic in it.
a) taste b) tasteful c) tasteless d) tasty
11. I'm afraid that the herring we had for supper has given me
a) indigestion b) indisposition c) infection d) sickness
12. The delicious spread of sweets made the child's mouth
a) cold b) dry c) water d) wet
13. Please put some more water in my coffee, because it is too
a) black b) dense c) strong d) thick
14. I loved the icecream, but the cake was a bit too sweet for my
a) appetite b) desire c) flavour d) liking
15. If there is one thing I don't like, it is tea.
a) delicate b) light c) pale d) weak
16. I wouldn't eat those gooseberries if I were you, they don't look to me.
a) formed b) ready c) ripe d) underdone
17. The dinner was excellent; the dessert was particularly
a) delicious b) desirable c) flavoured d) tasteful
18. Her pastry is as light as a
a) breath b) cloud c) feather d) leaf
19. Those vegetables are very tasty; I'm sure you would like them if you only them.
a) examined b) proved c) tested d) tried

**** 125. FOOD. Which are the odd men out?**

1. H e r b s: artichoke bay leaf chicory garlic
 marjoram marrow mint oregano
 rosemary sage thyme turnip
2. S p i c e s: cayenne pepper chilli cinnamon ginger
 horseradish pimento nutmeg vanilla
 vinegar white pepper

- | | | | | | | |
|----------------------|-------------------------------------|--|--|-------------------|-----|--------|
| 3. Pasta: | lasagne
pies | macaroni
ravioli | macaroons
spaghetti | noodles | | |
| 4. Poultry: | boar | chicken | duck | goose | hen | turkey |
| 5. Shellfish: | cockere
lobster
prunes | cockles
mussels
shrimp | crab
oysters | kipper
prawns | | |
| 6. Game: | barley
pheasant | grouse
pigeon | maize
venison | partridge | | |
| 7. Fish: | cod
herring
sole | deer
mackerel
trout | eel
plaice | haddock
salmon | | |
| 8. Alcoholic drinks: | ale
cider
mead
shandy | bourbon
gin
rum
squash | brandy
ginger beer
Scotch
whiskey | whisky | | |
| 9. Kinds of meals: | banquet
feast
refreshments | barbecue
lunch
sandwich | breakfast
picnic
snack | | | |
| 10. Kinds of wine: | bourbon
chianti
port
Tokay | burgundy
claret
shandy
vermouth | champagne
liqueur
sherry | | | |

126. MEALS. Put each of the following words into its correct place in the passage below.

afternoon	bacon	breakfast	juice
chocolate	continental	English	morning
lunch	meals	menu	syrup
rolls	second	supper	

Meals

Most people eat three a day — breakfast, and dinner. Some eat a fourth meal, , late at night. . . . tradition provides an extra light meal served in the late Its basic usually includes tea and special tea cakes or cucumber sandwiches.

Meals vary in different countries. . . . in the United States may include fruit or fruit coffee, toast, and a choice of cereal or and eggs. Many persons like pancakes with maple for breakfast. . . . Europeans sometimes have an early breakfast of and coffee or hot , and eat a breakfast later on in the

* 127. TASTE. Choose the right answer.

1. There is nothing more on a warm day than a glass of ice-cold fruit juice.
a) freshening b) quenching c) refreshing d) relaxing
2. The smell of the burnt cabbage was so that it spread to every room.
a) diffuse b) effusive c) extensive d) pervasive
3. Miss Greedy her lips at the thought of eating the delicious-looking cake.
a) pursed b) smacked c) struck d) watered
4. The taste of the apple pie in my mouth for a long time after dinner.
a) insisted b) lingered c) loitered d) prolonged
5. It was during my stay in India that I a taste for very hot curry.
a) acquired b) gained c) got d) received
6. Mr Hot some pepper over his steak.
a) spat b) sprayed c) sprinkled d) squirted
7. Mr Forgetful didn't put the milk in the fridge so it
a) went back b) went down c) went off d) went out
8. The of the pudding is in the eating. (proverb)
a) control b) probation c) proof d) trial
9. This cheese has gone You'll have to throw it away.
a) contaminated b) decayed c) mouldy d) stale
10. The steak looked tender, but it was as tough as
a) a belt b) a saddle c) old boots d) rubber
11. We couldn't use the milk because it had bad.
a) been b) come c) gone d) made
12. The smell was so bad that it completely us off our food.
a) got b) put c) set d) took

* 128. POTS AND PANS. Match the names with the pictures.

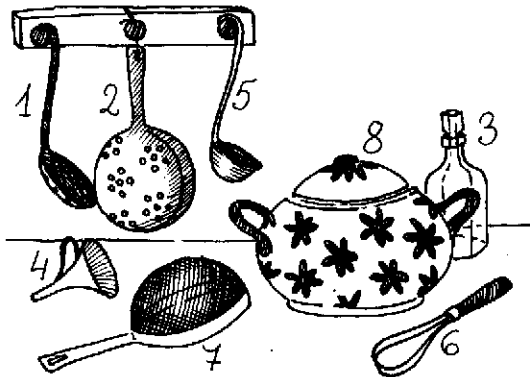

- | | | | |
|--------------|-----------|-----------------|-----------|
| ... colander | ... cruet | ... funnel | ... ladle |
| ... skimmer | ... sieve | ... soup tureen | ... whisk |

129. POTS AND PANS. Choose the right answer.

1. Having the table, Mrs Goodhousewife called the family for supper.
a) completed b) laid c) ordered d) spread
2. Aunt Betty gave me a of her home-made strawberry jam.
a) bottle b) can c) pot d) tin
3. Yvonne the cups and two of them broke.
a) dropped b) fell c) let fall d) spilt
4. It wasn't my that the plate broke.
a) blame b) error c) fault d) mistake
5. I put the milk back to the fridge.
a) flask b) holder c) jug d) vase
6. Dinner will be served but we have time for a drink before then.
a) actually b) currently c) lately d) presently
7. Put the lid back on the tin so that the biscuits crisp and fresh.
a) become b) bring c) get d) stay
8. Just put the dirty dishes in the We'll wash them up later on.
a) bath b) bucket c) sink d) tub
9. The plate was right on the of the table and could have been knocked off at **any** moment.
a) border b) edge c) margin d) tip
10. When you pour the coffee, be careful not to it in the saucer.
a) lead b) spill c) spit d) trip
11. Please give me two of bread.
a) crumbs b) flakes c) lumps d) slices
12. She her automatic cooker to cook the meat for seven o'clock.
a) arranged b) put c) set d) timed
13. My sister likes to the table, but she doesn't like to wash dishes.
a) lay b) lie c) make up d) sit
14. I can't the sound of a knife scraping on a plate.
a) bear b) suffer c) support d) sustain
15. Be careful how you that jug; it will break very easily.
a) hand b) handle c) operate d) pour
16. I see we've coffee — do you mind drinking tea?
a) done without b) gone off c) run out of d) turned out
17. I had a of soup for lunch.
a) bowl b) dish c) glass d) saucer
18. This knife is terribly It won't even cut a piece of cheese.
a) blunt b) flat c) sharp d) thick
19. We shall have to use that glass as we are a cup
a) few b) less c) minus d) short
20. I couldn't open the wine as I didn't have a
a) corkscrew b) corkdriver c) lever d) screwdriver

130. POTS AND PANS. Give the names of the following kitchen utensils.

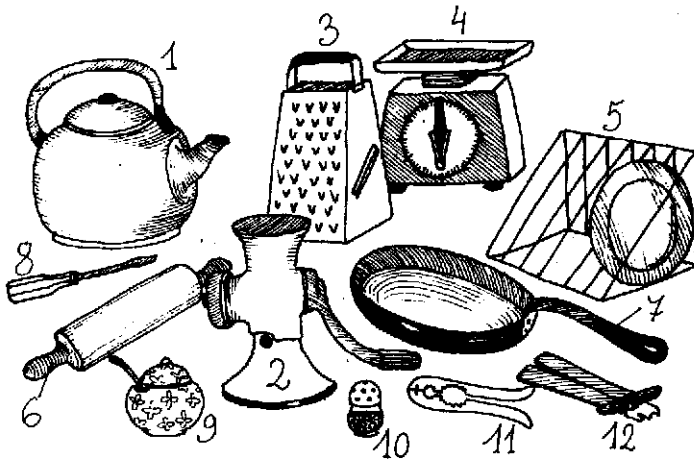

- | | | |
|------------------|----------------------|---------------------|
| 1. ____ t ____ | 3. plate _____ | 9. s _____ b _____ |
| 2. ____ n _____ | 6. r _____ - p _____ | 10. p _____ p _____ |
| 3. g _____ | 7. ____ r _____ | 11. _____ r _____ |
| 4. kitchen _____ | 8. ____ r _____ | 12. ____ o _____ |

131. POTS AND PANS. Choose the right answer.

- My Grannie presented me with four of home-made cranberry sauce.
a) bowls b) dishes c) jars d) jugs
- "How much sugar would you like in your tea, Miss Sweety?"
"Five, please."
a) fragments b) lumps c) parts d) squares
- That fish smells terrible! Throw it in the

 - bin
 - rubbish
 - sink
 - waste-paper basket

- Mr Strange poured the tea from his cup into his and then proceeded to drink it.
a) bowl b) dish c) plate d) saucer
- When you've washed up, the plates before you put them away.
a) clean b) dry c) dust d) sweep
- Don't put your hand on the hot stove, or you'll yourself.
a) burn b) cook c) fry d) grill
- Sometimes it is very difficult to get the out of a wine bottle.
a) cap b) cork c) lid d) plug
- Do be careful not to your tea on your white dress, darling.
a) drip b) filter c) leak d) spill

9. Let's have a cup of tea. Put the on.
a) cooker b) electricity c) kettle d) tea pot
10. Put the back on the biscuit tin, otherwise the biscuits will go soft.
a) cap b) fastener c) lid d) top
11. Be careful, this knife is very
a) acute b) blunt c) hard d) sharp
12. Don't the jug right up, otherwise you'll spill it when you pick it up.
a) feel b) fell c) fill d) full

*** 132. POTS AND PANS.** *Choose the right answer.*

1. Be careful not to the tray too much or the glasses will slide off.
a) bend b) incline c) tilt d) twist
2. Mr Clumsy tripped and sent the whole pile of metal plates to the ground.
a) clattering b) pattering c) tinkling d) thudding
3. She the tablecloth carefully and put it away in a drawer.
a) bent b) creased c) folded d) pleated
4. There was a sharp and the plate broke into two pieces.
a) bang b) crack c) crash d) noise
5. Separate the eggs and then beat with a
a) wick b) whip c) whisk d) wipe
6. These silver spoons need
a) buttering b) painting c) polishing d) varnishing
7. Sweep the off the tablecloth before you put it away.
a) crumbs b) dirt c) dust d) rubbish
8. You should always the plates with clean water after you have washed them.
a) damp b) rinse c) soak d) wet
9. WANTED: A sensible and person to assist with kitchen and cleaning duties.
a) adept b) capable c) serious d) worthy
10. He rubbed his finger round the of the glass.
a) ledge b) lip c) rim d) tip
11. A food mixer is a very useful to have in the kitchen.
a) gadget b) instrument c) scheme d) tool
12. There was a loud as the cup fell to the floor.
a) crash b) rattlè c) slam d) tap
13. The refrigerator was with food.
a) affluent b) bloated c) crammed d) full
14. We buy a month's supply of meat and keep it in the
a) cabinet b) container c) freezer d) holder
15. I could hear the of dishes in the kitchen as Mrs Hardworking was washing up.
a) clatter b) jingle c) rustle d) squeak

133. COOKING. Choose the right answer.

1. My mother always her own bread.
a) bakes b) fries c) grills d) roasts
2. She put a of chocolate on the cake.
a) colour b) cover c) layer d) level
3. You can't make an omelette without eggs. (proverb)
a) breaking b) crushing c) mixing d) smashing
4. A fat lady sat on my shopping bag in the bus and my tomatoes.
a) broke b) crushed c) squashed d) squeezed
5. A power failure completely the cake she was baking.
a) damaged b) injured c) ruined d) weakened
6. To make a good omelette, you must the eggs very well.
a) bang b) beat c) knock d) thrash
7. I loved the cake. Would you mind letting me have the for it?
a) menu b) prescription c) receipt d) recipe
8. To the best results, mix the powder with warm water.
a) expect b) find c) obtain d) require
9. Would you put the water on, please, ready to the potatoes.
a) bake b) boil c) braise d) brown
10. The recipe is a secret; it has been from father to son for generations.
a) handed down b) made up c) put off d) spoken of
11. Add the essence until the teaspoonful is beaten into the mixture.
a) drop by drop b) inch by inch c) leaf by leaf d) spot by spot
12. How do you like your eggs ?
a) done b) made c) ready d) set
13. Mrs Baker rolled out the pastry and cut it into pretty before baking it.
a) measures b) pictures c) shapes d) sizes
14. Don't the bottle or you will spoil the wine.
a) agitate b) shake c) stir d) tremble
15. She left the milk in a jug and a thick layer of formed on the surface.
a) butter b) cream c) fat d) skin
16. Frozen food should always be before it is cooked.
a) defrosted b) dissolved c) melted d) softened
17. Can you give me a teaspoon to my tea?
a) beat b) spin c) stir d) turn
18. It's important that while baking this cake the temperature should remain
a) consistent b) constant c) continual d) continuous
19. Chocolate if you keep it in your pocket.
a) flows b) melts c) ripens d) settles
20. When I peel onions, I can't stop my eyes from
a) dripping b) dropping c) leaking d) watering

134. COOKING. Match the method of cooking with its definition.

- | | |
|--------------|---|
| 1. baking | a. cooking in steam; used for puddings, fish, etc. |
| 2. boiling | b. the term used in meat cookery by which the meat is first browned, then has a small quantity of water added |
| 3. braising | c. cooking meat or fruit in a small amount of water and its own juices |
| 4. frying | d. cooking foods in enough water to cover them, at a temperature lower than 100°C |
| 5. roasting | e. cooking in fat; used for chips, doughnuts, etc. |
| 6. simmering | f. the food is placed in the oven; used for preparing cakes, breads |
| 7. steaming | g. is done by placing the food in the oven or over coals and cooking until it is tender; used for cooking meats |
| 8. stewing | h. cooking foods in enough water to cover them, at 100°C |

135. COOKING. Choose the right answer.

- The for making this pudding are clearly written on the packet.
a) directions b) explanations c) preparations d) ways
- The main of this drink are wine, vodka and orange juice.
a) components b) compositions c) ingredients d) parts
- Their last cook was better than their one.
a) current b) former c) instant d) latter
- that cold meat into neat, thin pieces.
a) sandwich b) slash c) slice d) slit
- Mr Butterlover spread the butter on his bread.
a) broadly b) deeply c) highly d) thickly
- Coming from the kitchen was a wonderful of cooking.
a) odour b) perfume c) scent d) smell
- Our cook is quite of cooking a meal for twenty-four people.
a) capable b) clever c) efficient d) expert
- I like my eggs soft , not hard.
a) boiled b) cooked c) steamed d) watered
- The meat must be cooked in the for one hour.
a) grate b) grill c) oven d) stove
- I don't like my steak cooked too long. I like it
a) burnt b) raw c) underdone d) well done
- Try some of this cake, which I especially for you.
a) browned b) fried c) made d) roasted
- Her sole in the hotel kitchen was peeling potatoes.
a) job b) profession c) role d) work

* 136. COOKING Choose the right answer.

1. This lime juice needs before you can drink it.
a) diluting b) dissolving c) softening d) watering
2. Unsalted butter is best for this recipe but, that, margarine will do.
a) except b) failing c) for all of d) given
3. Put the salt in the water and let it before adding the pasta.
a) dissolve b) melt c) mix d) soften
4. Before mixing, the whites of the eggs.
a) divide b) free c) part d) separate
5. This is a cut of meat which itself to long cooking.
a) adapts b) lends c) offers d) suits
6. If you don't lift that saucepan carefully, it will spill and you may yourself.
a) cut b) peel c) scald d) skin
7. Please look in the refrigerator and see if the jelly has
a) curdled b) hardened c) set d) stiffened
8. Dried vegetables are easy to use if you remember to them overnight.
a) bathe b) dampen c) soak d) water
9. The recipe says to use butter, but as we've run out we'll have to with margarine.
a) do away b) do it up c) make do d) make up
10. She the butter very thinly over the bread.
a) covered b) knifed c) scattered d) spread
11. Put the cake into a strong box, or it might get in the post.
a) clubbed b) crushed c) smoothed d) splashed
12. You should the fat from the meat before you cook it.
a) carve b) slice c) shave d) trim
13. Put the whites of five eggs into a basin, and beat them until they are
a) hard b) rigid c) solid d) stiff
14. Mr Hospitable a few slices off the joint for his guests.
a) bit b) carved c) chopped d) tore
15. "What a delicious cake. I didn't know you could cook so well." "I can't. It's just a"
a) flattery b) flop c) fluke d) fortune
16. Butter is covered with special paper so that no can get through.
a) cream b) grease c) oil d) paste
17. He the soda into his whisky.
a) sprayed b) sprinkled c) squeezed d) squirted

**** 137. COOKING** *What can you do to each of the following foodstuffs? Choose from the verbs given below.*

Foodstuffs:	Verbs:				
A. cream	baste	beat	bone	braise	carve
B. eggs	chop	crack	dice	grate	knead
C. fish	mash	mince	peel	poach	roll
D. meat	scramble	shell	shred	steam	stew
E. pastry	whip	whisk			
F. vegetables					

*** 138. COOKING** *Choose the right answer.*

1. She had just the shell of the hard-boiled egg and was starting to peel it.
a) burst b) cracked c) fractured d) shattered
2. Add the grated of two lemons to the cake mixture.
a) bark b) crust c) rind d) skin
3. When you have cracked the eggs, put the in the rubbish bin.
a) coverings b) covers c) shells d) skins
4. He always eats the soft parts of the bread and leaves the
a) bark b) crust c) edge d) shell
5. Would you some onions for me, please?
a) chip b) chop c) crack d) split
6. I'll cook the potatoes if someone will them first.
a) peel b) skin c) strip d) uncover
7. You will have to those peas before you cook them.
a) burst b) peel c) shell d) skin
8. Will you some cheese to put in this sauce?
a) chop b) grate c) grind d) powder
9. Rain and sun had swelled the pea, so that the peas inside were ready to be cooked.
a) husks b) pods c) rinds d) shells
10. Put the orange in the waste basket, not on the floor!
a) peel b) rind c) shell d) skin
11. Six oranges, two grapefruits and a small of grapes, please.
a) bunch b) cluster c) group d) heap
12. Don't forget to take the out of the cherries when you cook them.
a) grounds b) nuts c) seeds d) stones
13. A traditional English breakfast consists of at least two eggs and several of bacon.
a) rashers b) slices c) slivers d) strips
14. The second of cakes turned out much better than the first.
a) batch b) bunch c) group d) set
15. I don't like these oranges, they have too many
a) nuts b) pips c) seeds d) stones

139. FOOD AND COOKING. Complete the following sentences.

1. Which are your favourite vegetables: (brukselka) or (por)?
2. The best way to (zagotować) water is to put it in a (czajnik).
3. Carrots can be steamed or they can be eaten (surowe).
4. Could you (obrać) these oranges for me, please?
5. Indian (kuchnia) relies heavily on (ostre) spices.
6. Put the mixture in a baking (folia) and put it into a preheated (piekarnik).
7. (wymieszać) eggs, (mąka) and milk together in a large (miska).
8. With pizza even the best (składniki) may taste dull without the right (zioła).
9. A four (daniowy) meal of an (zakąska), soup, meat and dessert is enough for me.

140. RESTAURANTS. Choose the right answer.

1. The food my mother cooks is plain but
a) delicacy b) savoury c) tasteful d) wholesome
2. The food they serve here is excellent because they have a fine
a) chef b) cooker c) headwaiter d) stove
3. Game pie is the of the restaurant.
a) originality b) particularity c) singularity d) speciality
4. Miss Forgetful must remember to put the dinner invitation in her
a) agenda b) diary c) journal d) record
5. Two beers, please.
a) cold b) freezing c) frozen d) icy
6. Waiter, can I see the, please?
a) card of wines b) list of wines c) wine list d) wine menu
7. All the food in this little restaurant is
a) handmade b) home-based c) home-made d) self-made
8. What would you like for your first ? There are a lot of interesting things on the menu.
a) course b) dish c) meal d) plate
9. I enjoyed the dessert so much that I had a second
a) helping b) load c) pile d) sharing
10. By the time we got to the town, all the restaurants had
a) close b) over c) shut d) stopped
11. The food was badly cooked and I was most with it.
a) angry b) annoyed c) dissatisfied d) happy
12. Can I see the manager? I wish to about the terrible food I've been served.
a) complain b) criticise c) disapprove d) inquire
13. Mr Impatient to the head waiter about the slow service.
a) argued b) complained c) disputed d) questioned

14. The management is not loss or damage to customers' property.
a) in charge of b) liable to c) responsible for d) worrying for
15. The at that new restaurant is excellent.
a) attention b) attending c) care d) service
16. A new restaurant has opened here which specializes in French
a) cook b) cuisine c) feeding d) kitchen
17. I really don't like the way meals are here.
a) dished b) eaten c) helped d) served
18. I enjoy eating here because the staff are so
a) angry b) helpful c) subservient d) waiting
19. Mr Discontent wanted to complain to the waiter but was afraid of making a(n)
a) act b) drama c) play d) scene

141. RESTAURANTS — PAYMENT. Choose the right answer.

1. We must go now. Would you mind asking the waiter for the ?
a) account b) bill c) charge d) price
2. This voucher you to a free meal in our new restaurant.
a) allows b) credits c) entitles d) grants
3. As a service charge is included in the bill, any further tipping is
a) unforgivable b) unnecessary c) unpleasant d) unsatisfactory
4. Food is very expensive now as there's been yet another in prices.
a) advance b) gain c) increase d) lift
5. Let me the bill before we leave this restaurant.
a) arrange b) conclude c) pay up d) settle
6. Mr Generous decided to leave the waiter a big as the food and service had been excellent.
a) addition b) gift c) note d) tip
7. Try our delicious four-course meal, offering you superb for money.
a) cost b) price c) value d) worth
8. At many restaurants a service is included in the bill.
a) charge b) gratuity c) tax d) tip
9. "Is the tip included in the bill?"
"No, I don't think so. It says on the menu: GRATUITIES AT YOUR OWN"
a) consideration b) desire c) discretion d) will
10. You us to believe that service and V.A.T. would be included in the price.
a) led b) let c) made d) trickled

* 142. RESTAURANTS. Put the following names of food and drink under the right headings on the menu.

MENU:

- I. APPETIZERS
- II. SOUPS
- III. MAIN DISHES a) meats b) poultry c) fish
- IV. SIDE DISHES
- V. BEVERAGES
- VI. SWEETS
- VII. CHEESE

apple pie	dumplings	pork chops
apple sauce	Emmentaler	prawn cocktail
avocado vinaigrette	farmhouse cheddar	roast duck
beef Wellington	fried fillet of plaice	sole in white wine sauce
blue cheese salad dressing	fruit salad	spice cake
butter	game pie	spareribs
Camembert	grilled tomatoes	tossed green salad
cheese dip (fondue)	grilled veal fillet	turkey
coffee	hot chocolate	(roast beef and) Yorkshire pudding
cream of mushroom	hot fudge sundae	
creole haddock	peach melba	

* 143. RESTAURANTS. Choose the right answer.

1. Mr Extrovert guests to dinner almost every week.
a) amuses b) claims c) greets d) has
2. Mr Snob that only his club sells real English ale.
a) brags b) crows c) exults d) rejoices
3. Our restaurant can for parties of up to 300 people.
a) cater b) deal c) handle d) supply
4. Drop in for a to eat!
a) bit b) bite c) nip d) sip
5. Mr Newrich invited his guests to an expensive restaurant. However, he felt at ease.
a) ill b) painful c) sick d) unwell
6. The little country hotel served them a meal fit for
a) a king b) a lord c) an emperor d) a queen
7. He is to think that he is the only person who knows everything about good food.
a) apt b) impressed c) prejudiced d) subjected
8. Lobster is an expensive in most restaurants.
a) chaser b) delicacy c) flavour d) spice

144. FOOD, COOKING AND RESTAURANTS. Fill in the blanks with the right word.

1. She doesn't eat any sweets as she wants to _____ weight.
2. He drank almost all his coffee. There was only a little left at the _____ t _____ of his cup.
3. To make bread rise you use _____ a _____.
4. I love fruit, _____ l _____ peaches.
5. The yellow part of an egg is the _____.
6. Be careful with that knife! It is rather _____ h _____ and you might cut your finger.
7. Can I _____ u _____ some more tea into your cup?
8. As he didn't have enough cash to pay for his dinner, he made out a _____ q _____.
9. The sauce is terribly _____ . You put far too much pepper in it.
10. There was a strong _____ m _____ of fish.
11. We were _____ r _____ by a waiter with a _____ t _____ Italian accent.

145. FOOD, COOKING AND RESTAURANTS. Crossword.

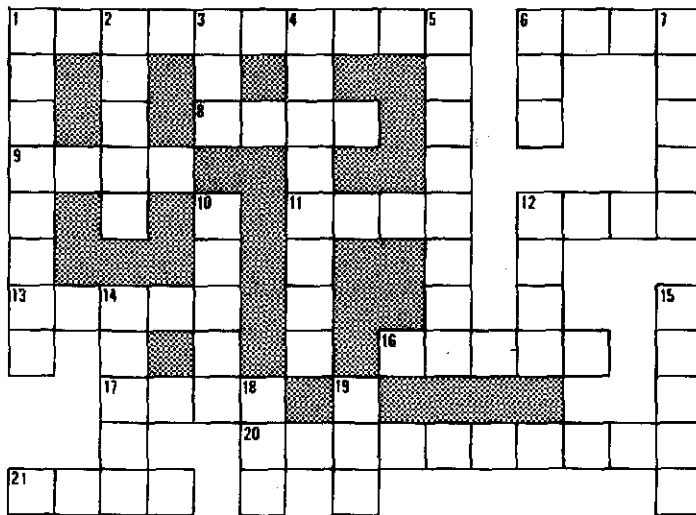

ACROSS:

1. what Japanese people eat with (10)
6. green vegetables found in pods (4)
8. skin of an orange or a potato (4)
9. thick slice of pork or lamb with a bone in it (4)
11. not well-done (4)
12. American maize (4)
13. cook without water (5)
16. used for carving (5)
17. flesh of a pig (4)
20. part of a recipe such as flour, eggs, etc. (10)
21. flesh of a bull (4)

DOWN:

1. pots, plates, cups made of baked clay (8)
2. an eye-watering vegetable (5)
3. to drink, taking a very small quantity at a time (3)
4. favourite dessert of children (8)
5. deep metal cooking pot with a lid and a handle (8)
6. made of pastry with apples or meat (3)
7. an item of cutlery (5)
10. main ingredient of all soups (5)
12. the main cook (4)
14. fruit popular in Poland (5)
15. rub cheese into small pieces (5)
18. young goat (3)
19. hard or soft boiled (3)

VIII. Gardening



Farmer's Wife: "Well, Bill, your master and I are going up to London for the cattle show."

Cowherd: "Oh, I'm sure you will take the first prize, ma'am."

Gardener: "Madam, one of your pets has got into my garden and is eating my bedding-plants."

Goat-Fancying Neighbour: "Good gracious! I trust they are not poisonous."

146. GARDENING. Choose the best answer.

1. Unfortunately, our garden is now by a block of flats.
a) looked over b) overlooked c) overseen d) seen over
2. He kicked the ball over the
a) garden wall b) garden's wall c) wall garden d) wall of garden
3. My garden gives me great, especially in spring-time.
a) appreciation b) benefit c) enjoying d) pleasure
4. The spade is a garden
a) instrument b) machine c) piece d) tool
5. Mr Careful kept the round his garden neatly clipped.
a) fence b) flowers c) hedge d) plants
6. It's raining hard now. Let's stand in that shed to
a) dry b) protect c) save d) shelter
7. "Get out of my garden, you nasty creatures!" the man shouted, shaking his at the children.
a) ear b) fist c) hand d) head
8. One of their new house is that it has no garden.
a) complaint b) disadvantage c) dislike d) pity
9. Our garden has been There are weeds growing everywhere.
a) miscarried b) neglected c) uncared d) unnoticed
10. We'd better the garden this evening. It hasn't rained for over ten days.
a) damp b) moisten c) water d) wet
11. He had to the mud off his shoes before coming into the house.
a) clear away b) kick c) scrape d) scratch
12. Mr Clever took of the fine weather to do a day's work in his garden.
a) advantage b) chance c) effect d) interest
13. The only problem about sitting in the garden in the evening is that you are likely to be by mosquitoes.
a) bitten b) eaten c) licked d) scratched
14. He is paving the garden with flat stones of various shapes.
a) alley b) lane c) path d) way
15. The main disadvantage to our house is that the only to the garden is through the bathroom.
a) access b) communication c) doorway d) passage
16. He threw the box out of the window and watched it fall to the outside.
a) flat b) ground c) plain d) soil
17. The is his garden was very rich and this enabled him to grow prize-winning lilies year after year.
a) fertility b) ground c) land d) soil
18. I am afraid the gate doesn't open; we will have to over it.
a) climb b) fly c) push d) walk
19. The outside the garden said "PRIVATE".
a) advice b) label c) notice d) signal

* 147. GARDENING. Choose the correct answer.

1. The garden was surrounded by wire.
a) barbed b) pricked c) spiked d) scratched
2. Our villa in Greece is on the top of a hill overlooking some olive
a) fields b) groves c) orchards d) meadows
3. The sack with the vegetables was far too heavy for me to carry, so I it across the floor.
a) dragged b) drew c) trailed d) threw
4. If I you again in my orchard, looking for pears, you'll be sorry!
a) catch sight of b) make eyes at c) see through d) take a view of
5. Mrs Lazy's garden had been badly neglected and was completely with weeds.
a) coated b) enclosed c) overgrown d) suffocated
6. Digging the garden is a very task.
a) conscientious b) exerting c) industrious d) laborious
7. If you want this apple tree to bear good fruit next year, you will have to it.
a) axe b) fell c) nip d) prune
8. All the farmers are in a terrible because of the water shortage.
a) attitude b) constitution c) disaster d) plight
9. I like sitting over there in the shade in the middle of that of trees.
a) bundle b) clump c) scrub d) stack
10. I was startled by the sound of a twig on the window.
a) creaking b) pattering c) rustling d) tapping
11. If you want a beautiful lawn, you will have to it.
a) hoe b) mow c) prune d) uproot
12. Our garden has become a since the house was abandoned, with weeds growing everywhere.
a) desert b) moor c) swamp d) wilderness
13. A last swing of the axe sent the old tree to the ground.
a) bursting b) crashing c) rushing d) roaring
14. In our garden, we can sunbathe on the in the summer.
a) field b) flowerbed c) lawn d) meadow
15. I was able to see the garden through a in the hedge.
a) cleft b) gap c) groove d) slot
16. Keep out! will be prosecuted!
a) Entrants b) Newcomers c) Transgressors d) Trespassers
17. Can you hold the ladder while I climb up and pick the apples?
a) firm b) rigid c) solid d) steady
18. The windows opened onto the garden.
a) Dutch b) English c) French d) Spanish
19. That old apple tree us from the sun on hot days.
a) fences b) prevents c) shades d) warns
20. How do you his sudden interest in gardening?
a) account for b) give c) mean d) suggest

148. GARDEN TOOLS. Match each of the following names for garden tools with the correct picture below.

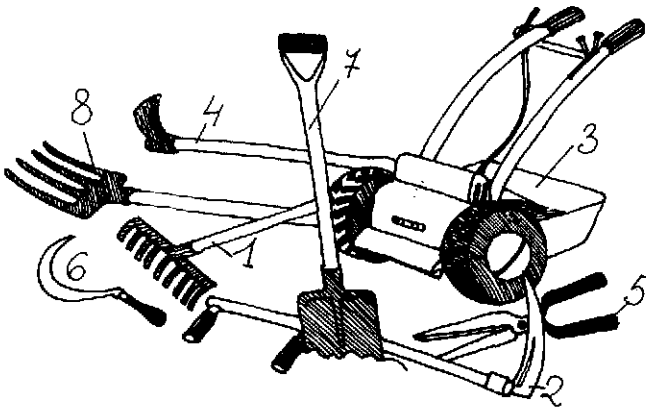

fork hoe lawnmower rake scythe shears sickle spade

149. GARDENING. Complete the following sentences. Each letter is represented by one dash (—).

1. He got his hands — — — t — working in the garden and had to wash them.
2. "What is the — — — — — of your new garden?" "I don't know exactly, but it can't be larger than 50 square metres."
3. We are having an early summer this year. The tulips in my garden came into — — — w — — at least three weeks earlier than last year.
4. Our countryside is particularly beautiful in spring, when the — — — h — — — — — are in bloom.
5. Do you — — — — — turnips in your garden?
6. I have been working very hard, but the ground is frozen so hard that after two hours of — — — g — — — — the hole is only 2 feet deep.

150. FLOWERS. Give the English names of the following flowers. Each dash (—) represents one letter.

1. fiołek = v — — — — —
2. goździk = c — — — — —
3. mieczyki = g — — — — — i
4. niezapominajka = f — — — — — n — —
5. stokrotka = d — — — — —
6. żonkil = d — — — — —

151. FLOWERS. Choose the correct answer.

1. I am growing some geraniums in my window
a) box b) case c) shelf d) tin
2. My mother very fine roses in her garden.
a) breeds b) develops c) grows d) raises
3. As the flowers had she threw them away.
a) dead b) discoloured c) faded d) fallen
4. Playing games in the flower garden is
a) defended b) dismissed c) forbidden d) refused
5. I'll put the flowers in this They'll look nice there.
a) bucket b) crystal c) mug d) vase
6. After searching for a long time, the children found their ball in the by the lilac bushes.
a) underground b) undergrowth c) underpass d) underworld
7. Look! He has brought you a beautiful of flowers.
a) branch b) bunch c) bush d) twig
8. I am going into the garden to some flowers.
a) grip b) pick c) seize d) snatch
9. The roses were still in December when the first snow began to fall.
a) blooming b) blossoming c) fading d) growing
10. He his rose bushes carefully with insecticide every week.
a) distributed b) spat c) sprayed d) spread

152. FLOWERS. Put each of the following words or phrases into its correct place in the passage below.

animals	apple	blossom	botanists
cattle	colourless	flowering	food
grains	include	man	mean
produces	reproductive	roots	roses
seeds	sheep	stem	vegetables

Flowers

The word *flower* may either 1) the blossom or 2) the whole plant. used the word *flower* to mean only the of a plant. They call the whole plant — blossom, , leaves, and — a flowering plant.

Any plant that some sort of flower, even a tiny, one, is a flowering plant. Grasses, , lilies, trees, and oaks are all flowering plants.

Flowers are the part of plants. The plant could not develop and reproduce without them. depends completely on flowers and flowering plants for his Flowering plants almost all of our , fruits, and Even the that we use for food, such as , pigs, and , live on flowering plants.

153. VEGETABLES. Give the Polish names of the following vegetables. Each dash (—) represents one letter.

1. brussels sprouts = b _____
2. eggplant/aubergine = o _____
3. garlic = _____
4. horse-radish = _____
5. leek = _____
6. parsley = _____
7. pepper = _____
8. radish = _____
9. turnip = r _____
10. watermelon = _____

154. VEGETABLES. Put each of the following words or phrases into its correct place in the passage below.

cereal	come	cooked	difficult
eat	entire	foods	fruits
kingdom	mean	oats	plants
processed	raw	roots	

Vegetables

We vegetables every day, yet it is very to say exactly what we by the word *vegetable*. Sometimes the word is used in the phrase “the vegetable”, which means very much the same thing as the world of plants.

According to another meaning, vegetables are that we obtain from the leaves, flowers, or of plants.

Vegetables are usually eaten without first being or milled as grains such as wheat and are.

Vegetables are also considered different from Fruits generally may be eaten just as they from the , while vegetables are more often But even this rule is not absolute.

IX. Health and Medicine



Grandmother lay back on her pillow, a comfortable look on her face.

"I feel much better today," she said. "I don't think my appendix will have to be removed." She beamed happily. "But it was nice of the minister to call and see me."

"Grandma, that wasn't the minister. That was a doctor from the city who examined you."

"Oh," granny replied. "I thought he was a little familiar for a minister."

*

Professor: "What kept you out of class yesterday — acute indigestion?"

Student: "No, a cute engineer."

155. BODY. Give names for the indicated parts of the head.

1. _____
2. _____ e _____
3. _____ b _____
4. _____ s _____
5. _____ e _____
6. _____ e _____
7. _____ t _____
8. _____ u _____
9. _____
10. _____ h _____
11. _____ a _____
12. _____ c _____

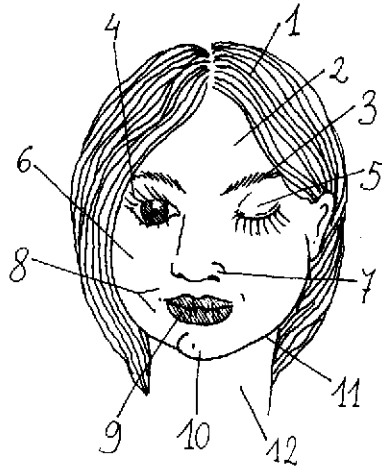

156. BODY. Match each of the following parts of the body with the correct number in the picture below.

- | | | | |
|-------------|------------------|------------|------------|
| ... abdomen | ... Adam's apple | ... ankle | ... armpit |
| ... biceps | ... bottom | ... breast | ... calf |
| ... elbow | ... forearm | ... groin | ... heel |
| ... hip | ... knee | ... navel | ... nipple |
| ... palm | ... shoulder | ... thigh | ... throat |
| ... thumb | ... toe | ... waist | ... wrist |

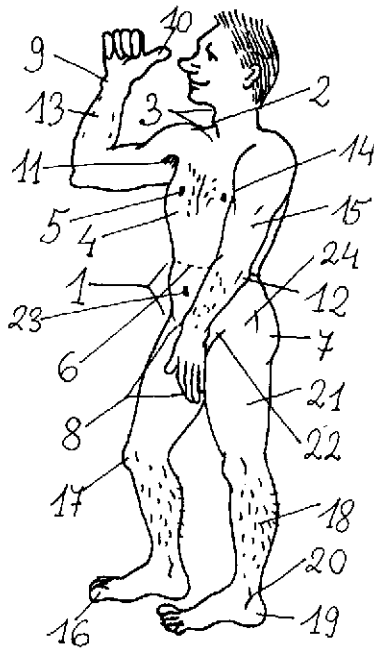

*** 157. BODY.** Choose the correct answer.

1. The PUPIL is part of the
a) ear b) stomach c) eye d) hand
2. The SOLE is part of the
a) hand b) foot c) eye d) ear
3. The CALF is part of the
a) leg b) arm c) chest d) head
4. The WRIST is part of the
a) hand b) foot c) eye d) ear
5. The IRIS is part of the
a) hand b) foot c) eye d) ear
6. The HEEL is part of the
a) hand b) foot c) eye d) breast
7. The PALM is part of the
a) hand b) foot c) ear d) breast
8. The NIPPLE is part of the
a) hand b) foot c) ear d) breast
9. The THUMB is part of the
a) hand b) foot c) head d) chest
10. The SHIN is part of the
a) arm b) leg c) head d) breast

158. BODY. Give names of the bodily organs indicated in the picture below.

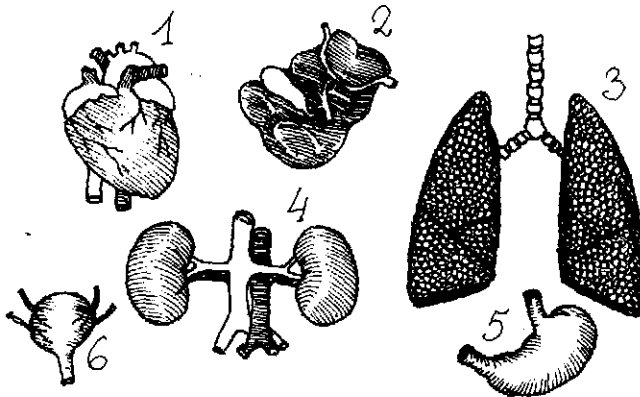

1. 2. 3. 4. 5. 6.

**** 159. BODY.** Match the Polish names of the parts of the body with their English counterparts.

- | | |
|--------------------|-----------------------|
| 1. bile duct | a) jelito grube |
| 2. bladder | b) kręgosłup |
| 3. gall bladder | c) krtań |
| 4. large intestine | d) miednica |
| 5. larynx | e) pęcherz moczowy |
| 6. pancreas | f) przewód żółciowy |
| 7. pelvis | g) śledziona |
| 8. spine | h) tchawica |
| 9. spleen | i) trzustka |
| 10. windpipe | j) pęcherzyk żółciowy |

160. BODY. Match the following parts of the body with the jumbled definitions on the right.

- | | |
|--------------|---|
| 1. kidney | a. organ in the head which controls thought and feeling |
| 2. lung | b. long pipe leading from the stomach which takes waste matter from the body |
| 3. liver | c. two small, fleshy organs in the throat |
| 4. heart | d. baglike organ in which food is broken down for use by the body |
| 5. brain | e. one of twenty-four bones protecting the chest |
| 6. intestine | f. one of a pair of organs which separate waste liquid from the blood |
| 7. appendix | g. one of two bony parts of the face in which teeth are set |
| 8. tonsils | h. large organ which cleans the blood |
| 9. rib | i. one of a pair of breathing organs in the chest |
| 10. stomach | j. passage from the back of the mouth down inside the neck |
| 11. jaw | k. short organ of little use which leads off the large intestine |
| 12. throat | l. organ in the chest which controls the flow of blood by pushing it round the body |

161. BODY. Choose one of the four possibilities that best completes the sentence.

1. He must be terribly strong! Look at his
a) skin b) limbs c) muscles d) nerves
2. He stood with his hands on his daring me to go past him.
a) ankles b) knees c) shoulders d) hips
3. Every tooth in my upper seemed to be aching.
a) chin b) cheek c) jaw d) forehead
4. When Mary twisted her ankle, John carried her home on his
a) shoulders b) knees c) hands d) arms
5. His shoes were so old that his were sticking out of them.
a) fingers b) thumbs c) tips d) toes

6. The blind man ran the of his fingers over the box.
a) points b) edges c) tips d) ends
7. When people sweat, the liquid comes out through the of the skin.
a) veins b) vents c) pores d) holes
8. The is the main air passage of the body.
a) intestine b) ear c) windpipe d) kidney
9. The main function of the heart is to blood round the body.
a) push b) propel c) pump d) walk
10. Arnold Schwarzeneger has an enormous chest
a) growth b) swelling c) expansion d) inflation

* 162. **BODY.** Complete the sentences. The number of dashes is identical with the number of letters in the missing words.

1. We have ten _ _ _ _ _ on our hands and ten _ _ _ _ s on our feet.
2. The function of the heart is to enable the _ _ _ o _ _ _ to circulate.
3. The _ _ _ _ _ a _ _ _ is used for digesting food.
4. The flesh your teeth grow from is your _ _ _ _ _.
5. Do you wear your watch on your right _ _ _ _ s _ _ because you are left-handed?
6. A bear crushed him and cracked several of his _ _ _ _ s.
7. With the help of our _ _ _ _ _ u _ _ we are able to speak and eat.
8. Our _ _ _ _ i _ _ enables us to think.
9. At first she thought the boy had a high temperature, but when she put her hand on his _ _ _ _ e _ _ _ _ _ to make sure, she found it was cold.
10. I dropped a heavy box on my _ _ _ _ _ and broke one of my toes.

163. **BODY.** Crossword.

ACROSS:

1. either of the milk-producing parts of a woman (6)
6. conducts blood away from the heart (6)
7. part of the body that includes the bowels (7)
8. of or for the teeth (6)
9. a large box or part of the body (5)
10. any one of the twelve pairs of curved bones in the chest (3)
12. a tree or part of the hand (4)
16. flat sea-fish with a delicate flavour or under surface of the foot (4)
17. a flower or part of the eye (4)
18. movable cover for the teapot or flap of skin that covers the eye (3)
19. for hearing (3)

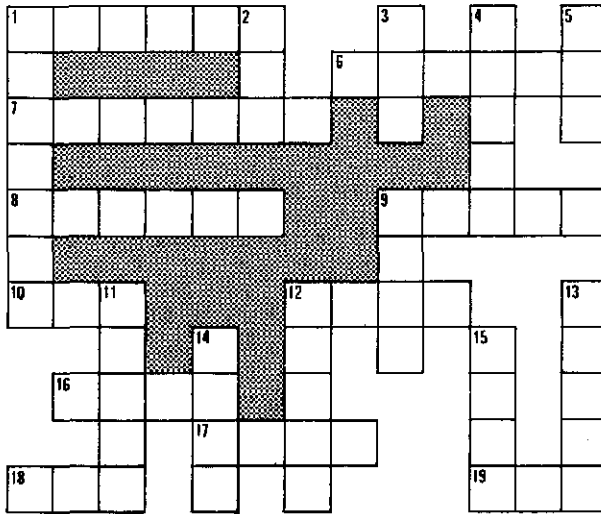

DOWN:

1. organ shaped like a bag in which urine collects (7)
2. one of five on your foot (3)
3. the part of the body from the shoulder to hand (3)
4. conducts impulses from the brain (5)
5. for seeing (3)
9. a young cow or part of the leg (4)
11. fills your veins (5)
12. a schoolboy or part of the eye (5)
13. a large organ which produces bile and cleans the blood (5)
14. conducts blood back to the heart (4)
15. for smelling (4)

*** 164. BODY.** Each of the ten words below are regularly used to describe an action or gesture made with a part of the body. Write which. In some cases more than one answer is possible.

- | | | | | |
|-----------|----------|--------------|----------|-----------|
| 1. blink | 3. cross | 5. nod | 7. point | 9. snap |
| 2. clench | 4. fold | 6. stick out | 8. shrug | 10. stamp |

165. DENTAL CARE. Choose the right form.

1. Dentists recommend brushing teeth with a fluoride toothpaste to them from decay.
a) arm b) defend c) guard d) protect
2. Have you got toothache? Your face looks
a) big b) enlarged c) expanded d) swollen
3. I had to have two when I went to the dentist last week.
a) cavities b) fillings c) paddings d) refills

4. She always pays visits to the dentist.
a) customary b) habitual c) normal d) regular
5. The dentist told him to open his mouth
a) broad b) greatly c) much d) wide
6. He when the dentist touched the bad tooth.
a) alarmed b) dreaded c) laughed d) winced
7. Robert is very about the cost of his dental treatment.
a) ashamed b) pained c) sorry d) worried
8. I'm having to pay yet another visit to the dentist.
a) afraid b) dreading c) frightened d) terrified
9. The in one of my teeth has come out, so I'm going to the dentist.
a) cover b) completion c) filling d) replacement
10. He made a note of the appointment with his dentist in his
a) diary b) directory c) journal d) register
11. She phoned her dentist to say she was unable to her appointment.
a) arrive b) hold c) keep d) stand
12. She put going to the dentist although her teeth needed attention.
a) away b) in c) off d) out
13. The small girl had to have four teeth because they were so bad.
a) broken b) pulled c) taken away d) taken out
14. The loss of a front tooth has left an unsightly in her teeth.
a) gap b) hole c) slot d) space
15. In some countries more and more young people now need teeth.
a) false b) spare c) unnatural d) untrue

* 166. **DENTAL CARE.** *Fill the blanks with the words below. You may need to change the form of the words. Each word can be used only once.*

cavity	cement	dentist	dentures	disease	equipment
examine	fill	gums	interval	lose	nerve
pain	practice	preventive	tooth	treat	treatment

General Dental Practice

General dental includes mouth examination, diagnosis, treatment, and prevention of There frequently uses X-rays and other to ensure correct diagnosis and

Treatment may include filling , removing the of teeth, treating diseases of the , removing , and replacing teeth with bridges and Anesthesia is often used in any treatment that might cause Teeth may be with amalgam, or

Perhaps one of the most important parts of a dentist's work is dentistry. If a dentist a patient's teeth at regular , he may find and a disease before it becomes serious.

167. DIET. *Choose the right answer.*

1. Overweight people have to avoid exercises.
a) an affectation b) a disposition c) an inclination d) a tendency
2. You should take more exercise if you want to keep
a) fat b) fine c) fit d) fresh
3. The doctor told her that she would be well-advised to some weight.
a) leave b) light c) lose d) sell
4. After her diet, she looked very and healthy.
a) hungry b) skinny c) slim d) thin
5. Very fat men sometimes have a at the back of the neck.
a) double chin b) roll of fat c) spare tyre d) ton of flesh
6. The doctor advised my mother to keep a watch on her weight.
a) near b) severe c) strict d) tight
7. It's important to keep your body in good
a) contour b) figure c) form d) shape
8. You shouldn't eat so much chocolate meals.
a) between b) else c) except d) through
9. She has put a lot of weight since last year.
a) down b) in c) off d) on
10. She remained depressingly fat all her efforts to slim.
a) against b) although c) contrary d) despite

*** 168. DIET.** *Fill in the blanks with the words below. You may use each word only once.*

activity	children	dietary	energy	include
lean	nursing	nutrients	people	person
products	rapidly	tissue	well-balanced	

Special Diets

Certain groups of , such as young children or older people, have special needs. Because grow , they need food not only to replace worn-out tissues and provide , but also to build new

A child's diet should milk and milk , eggs, meat, poultry, fish, fruits, vegetables, and cereals.

A diet is important to the older as it is to the child. Older people need as many as young adults. But if their is reduced, they will need fewer calories. Expectant or mothers and babies also need special diets.

*** 169. DIET.** *Choose the correct answer.*

1. There's an old saying, "it's the double gins that cause the".
a) crossed eyes b) double chins c) flat feet d) knock knees
2. Exercise tends to the effects of old age.
a) offset b) run down c) set back d) waylay
3. A diet high in carbohydrates contains little of the material needed to build up tissue.
a) calorific b) digestible c) nourishing d) sustaining
4. He will have to go on a diet because he is worried that he is
a) buxom b) chubby c) robust d) strong
5. I think you'll find that the inconvenience of the diet is by the benefits.
a) outranked b) outweighed c) overbalanced d) overthrown
6. When there is excessive obesity patients are sometimes put on a diet which enable them to lose weight extremely quickly.
a) balanced b) crash c) light d) slim
7. your food will give you indigestion.
a) Bolting b) Cramming c) Gorging d) Munching
8. When dieting, eat only to satisfy your hunger , not to gratify your desire to eat.
a) aches b) pangs c) spasms d) twinges

**** 170. DISEASES.** *Give the Polish names of the following diseases.*

- | | | |
|-----------------|--------------|------------------|
| 1. appendicitis | 5. diabetes | 9. leukemia |
| 2. bronchitis | 6. hay fever | 10. measles |
| 3. cancer | 7. hepatitis | 11. pneumonia |
| 4. chicken pox | 8. influenza | 12. tuberculosis |

171. DISEASES. *Choose the correct answer.*

1. She died after a long
a) disease b) failing c) illness d) sickness
2. The doctor had three of nose-bleeding in the same day.
a) aspects b) cases c) examples d) illnesses
3. He still suffers from a rare tropical disease which he while in the Congo.
a) contracted b) gained c) infected d) received
4. My grandmother is very old and is not very good health.
a) from b) in c) on d) with
5. The teachers at the school went with flu one after another.
a) down b) off c) out d) under

6. Malaria is by the female mosquito.
a) broadcast b) sent c) transmitted d) transported
7. Mary is in bed with a attack of flu.
a) hard b) heavy c) large d) severe
8. My brother was ill yesterday and is now in hospital.
a) broken b) caught c) fallen d) taken
9. The school is half empty as a serious epidemic of measles has broken
a) down b) in c) out d) up
10. Several of malaria have been reported.
a) cases b) doses c) occurrences d) types
11. To our , Mary's illness proved not to be as serious as we had feared.
a) anxiety b) eyes c) judgement d) relief
12. He a rare disease when he was working in the hospital.
a) caught b) infected c) suffered d) took
13. My headaches are usually brought by worry.
a) in b) on c) up d) out
14. The doctor examined him carefully and influenza.
a) concluded b) decided c) diagnosed d) realised
15. Some diseases quickly from one person to another.
a) catch b) get about c) move d) spread
16. Tropical diseases are comparatively in Poland.
a) few b) rare c) scarce d) slight
17. It was a minor illness and he soon got it.
a) around b) on with c) over d) up to
18. The last thing I want now is to catch a cold.
a) extremely b) most c) utterly d) very
19. I can never touch lobster because I am to shellfish.
a) allergic b) infected c) sensible d) sensitive
20. She couldn't go out because she had a cold.
a) flowing b) leaking c) running d) streaming
21. The local medical officer reported a serious of food-poisoning.
a) event b) incident c) outbreak d) state
22. The patient his illness down to a virus infection.
a) laid b) placed c) put d) traced
23. You keep sneezing. You must have caught
a) a cold b) a cough c) a headache d) an illness
24. The children were suffering from the of the hot weather.
a) consequences b) effects c) products d) results
25. He had a very bad cold and couldn't stop
a) sneezing b) snoring c) spitting d) yawning

172. DISEASES. *Fill in the blanks.*

1. He often _____ r _____ from bronchitis.
2. That's right, darling, Mummy's got a fat tummy because she's _____ g _____.
3. She is colour-blind, which means that she can't _____ n _____ between colours.
4. I am allergic to this kind of pollen. I start _____ e _____ any time it gets into my nose.
5. She is not coming today. She has got a _____ cold.
6. Please don't cough all over everyone! Your cold may be _____ t _____.
7. The epidemic seems to be dying out: only four _____ e _____ of cholera were reported last week.
8. The illness from which Alice is suffering has now been _____ i _____ as pneumonia.
9. I have a sore _____ o _____; perhaps I smoked too many cigarettes yesterday.
10. I had to stay in bed because I had _____ g _____ a cold.
11. It was just a _____ l _____ attack of bronchitis.
12. I am very _____ i _____ about her health. She seems so weak and has a high temperature.

**** 173. DISEASES.** *The following are terms referring to some types of diseases. Match the types with their definitions.*

- | | |
|-------------------|--|
| 1. acute | a. indicating hypersensitivity to particular foods, kinds of pollen, insect stings, etc. |
| 2. allergic | b. caused by mental stress |
| 3. chronic | c. coming sharply to a crisis |
| 4. congenital | d. lasting for a long time |
| 5. contagious | e. due to disturbances in anabolic and catabolic processes |
| 6. familial | f. transmitted genetically from parent to child |
| 7. infectious | g. caused by improper diet |
| 8. metabolic | h. spread by bacteria or viruses |
| 9. nutritional | i. present from or before birth |
| 10. psychosomatic | j. spreading by physical contact |

**** 174. DISEASES.** *Choose the best answer.*

1. Children with diseases should not be allowed to go to school.
a) constant b) contact c) infectious d) influential
2. He has bronchitis. He has suffered from it for many years.
a) chronic b) durable c) fatal d) mortal
3. I have been advised to take every against catching flu again this winter.
a) precaution b) prediction c) premeditation d) prevention

4. After the outbreak of a mysterious illness, investigation revealed of the town's water supply.
a) contagion b) eruption c) infiltration d) pollution
5. Apart from the cough and cold, I have been remarkably healthy all my life.
a) irregular b) odd c) opportune d) timely
6. Smallpox, once responsible for millions of deaths, has been virtually
a) abolished b) eradicated c) erased d) exterminated
7. Unless we take immediate precautions, we shall not be able to the epidemic.
a) contain b) destroy c) hold d) staunch
8. Peter can't play with the children next door because he is still in with measles.
a) confinement b) detention c) seclusion d) quarantine
9. The outbreak of whooping cough among children under 5 has now reached proportions.
a) contagious b) endemic c) epidemic d) pathological
10. My little daughter is not allowed to play with her friends next door because one of them is suffering from a disease.
a) contagious b) contiguous c) touching d) transmitting
11. An illness that is caused by the mind is known as illness.
a) an acute b) a congenital c) a familial d) a psychosomatic
12. She suffers from a morbid fear of spiders, known to doctors as
a) agoraphobia b) arachnophobia c) claustrophobia d) xenophobia

175. DISEASES. *Fill the blanks with the words below. You may use each word only once.*

bacteria	body	break	dangerous	delicate
disease	eyes	germs	line	liquids
membrane	moisture	mouth	nose	parts
prick	skin	sneeze	stomach	

How the Body Fights Disease

The is often called „the body's first of defence". It acts as armour, resisting many germs that might harm the more parts of the Any in the skin, even a pin , provides an opening for germs. Some enter the body through the and and other natural openings. These areas provide warmth and , in which germs thrive. When the of the nose and throat becomes irritated, we cough or , blowing out the unwanted substances.

Other body also provide a defence against Tears, for example, wash from the Tears also contain substances that fight bacteria. Acid in the kills many germs before they can reach other of the body.

176. DRUGS. *In most cases drugs are*

1. *taken by mouth*
2. *injected into the body*
3. *applied to the body surface.*

Divide the following forms of drugs into the three groups.

capsules	cream	gargle	jelly	lotion	lozenge	ointment
pill	powder	serum	tablet	vaccines		

177. DRUGS. *Choose the right answer.*

1. The nurse put a on the wound.
a) bandage b) cloth c) material d) towel
2. Take two of these three times a day after meals.
a) capsules b) drugs c) placebos d) prescriptions
3. Illness can be stopped before it happens by means of
a) after-care b) prescription c) therapy d) vaccines
4. If you've got a headache, why don't you take a of aspirin?
a) couple b) couplet c) pair d) prescription
5. Can you a good pill against airsickness?
a) advise b) propose c) recommend d) suggest
6. The is a teaspoonful, to be taken three times a day. You must not exceed it.
a) dose b) measure c) medicine d) quantity
7. Barbiturates are drugs which are often used in the of emotional disorders.
a) cure b) healing c) improvement d) treatment
8. Many herbs are well known for their healing
a) contents b) medicines c) parts d) properties
9. The doctor prescribed tablets to help the pain.
a) calm b) lighten c) relieve d) rid
10. He threatened to drink the chemical.
a) deadly b) deathly c) dying d) mortal
11. The doctor gave me some for my rheumatism.
a) gargle b) lozenges c) pastilles d) pills
12. As the drug took the patient became quieter.
a) action b) effect c) force d) influence
13. It's time to take another of medicine.
a) cup b) dose c) drink d) spoon
14. The effects of the anaesthetic used for the operation take quite a time to off.
a) give b) move c) turn d) wear
15. One way to get rid of hiccups is to your breath for as long as possible.
a) catch b) draw c) hold d) take

16. She's suffering from a of iron and needs to take a course of tablets.
a) default b) defect c) deficiency d) deficit
17. After his illness, the doctor gave him medicine to another attack.
a) deny b) improve c) prevent d) recover
18. You'll feel better after you've taken a of cough medicine.
a) dose b) helping c) portion d) ration
19. Take the tablets twice a day in two tablespoons of water.
a) dissolved b) melted c) resolved d) solved
20. The medicine he takes can only the pain. It cannot get rid of it completely.
a) heal b) remedy c) relieve d) solve

* 178. **DRUGS.** *Fill the blank with the right word from the list below. You may use each word once only.*

antiseptic cleanse disease fester ointment plaster skin wound

Treatment of a Minor Injury

. the wound thoroughly and apply an to counteract germs which spread
Otherwise the wound may Sticking may be applied or the may be
bandaged. may be smeared over the

* 179. **DRUGS.** *Choose the right answer.*

1. The doctor gave the woman a strong to calm her down.
a) antidote b) antiseptic c) bromide d) sedative
2. Morphine is sometimes used to severe pain.
a) deaden b) decimate c) smother d) suffocate
3. I hope this headache soon.
a) comes away b) goes out c) passes away d) wears off
4. Few poisons are more than cyanide.
a) deathly b) killing c) lethal d) mortal
5. The nurse made him swallow a(n) to help him sleep better.
a) lotion b) lozenge c) ointment d) tranquilliser
6. Beside washing that cut, put some on it in case you have got some dirt in it.
a) antidote b) antiseptic c) disinfectant d) medicine
7. Certain vitamins help to overcome a loss of
a) life b) vitality c) vitiation d) vividness
8. The medicine was so that he was almost back to normal within a few days.
a) effective b) efficient c) influential d) proficient

9. He was in terrible pain, so he was given a(n)
a) injection b) scratch c) stab d) wound
10. She has killed herself. She took a(n) of sleeping pills.
a) excess b) exorbitance c) overdose d) profusion
11. This is a very rare poison for which there is no known
a) antibody b) anticoagulant c) antidote d) antiseptic
12. They on a cure for tuberculosis while they were doing research on something else.
a) foundered b) stumbled c) tripped d) trod

*** 180. DRUGS.** *Fill the blanks with the right word from the list below. You may use each word only once.*

administer	after	antibodies	diseases	fight	generally
harmless	including	injected	orally	prevent	prevention
serums	smallpox	substances	symptoms	vaccines	

Drugs That Prevent Disease

Doctors use two main types of drugs for the of disease:

1. Vaccines contain dead or germs. They cause the body to develop called that act to disease. Doctors before a person has been exposed to such as poliomyelitis or Vaccines are usually but sometimes are given
2. Serums contain antibodies that off the germs of certain diseases, scarlet fever and lockjaw. These drugs are given a person has been exposed to the disease, or after of the disease have appeared. are administered by injection.

181. DRUGS. *Choose the right answer.*

1. Doctors write a for medicine which chemists or dispensers make up.
a) certificate b) prescription c) receipt d) recipe
2. The of the sugar is of course to sweeten the medicine.
a) cause b) need c) purpose d) reason
3. the bottle well before you pour out the medicine.
a) Agitate b) Shake c) Stir d) Tumble
4. A chemist always puts a on a bottle of medicine.
a) label b) receipt c) programme d) ticket
5. Don't lay that bottle on its side: the top might start
a) falling b) leaking c) spilling d) spreading
6. All medicines should be kept out of of children.
a) contact b) hand c) reach d) touch

7. Aspirin is generally as the best remedy for a headache.
a) considered b) regarded c) supposed d) valued
8. Put the back in the bottle. You might spill the medicine.
a) cork b) lid c) plug d) tap
9. The doctor gave me some medicine to my cold.
a) comfort b) cure c) mend d) repair
10. He the medicine quickly and then drank some orange juice.
a) licked b) spat c) swallowed d) sucked
11. That medicine was horrible! Give me a piece of chocolate to take the away.
a) bitter b) feeling c) sensation d) taste
12. The doctor told him to keep the tablets in his mouth and them slowly.
a) bite b) eat c) swallow d) suck

*** 182. DRUGS.** *Fill the blanks with the words from the list. You may need to change the form of the words. You may use each word once only.*

acute	apply	case	compress	condition
cream	different	disorders	fold	lotion
nature	necessary	ointment	part	skin
strongly	treatment			

Pimafucort Presentations

The presentations of Pimafucort are especially adapted to the of various skin For treatment of and subacute skin disorders and in the treatment of of the hairy of the skin, and those localized in the skin , Pimafucort and Pimafucort should be used, whereas in the of chronic disorders of the skin with desquamations, dry or fissured skin lesions, Pimafucort ointment will be For acute, very moist skin disorders it may be to use Pimafucort cream or Pimafucort lotion with a In some an "alternating treatment" may be indicated, e.g. in intertriginous eczema (in this instance Pimafucort softens the too much, whereas the cream and lotion dehydrate it too).

*** 183. DRUGS.** *Choose the right answer.*

1. The label said "It is dangerous to the stated dose".
a) exceed b) infringe c) overdo d) repeat
2. What you need is a good rest, so I think a holiday would be more than giving you more drugs.
a) benefaction b) beneficial c) benefiting d) benevolent
3. In Britain women who are pregnant are from prescription charges.
a) exempt b) freed c) free d) released
4. I always take aspirin when I have a headache.
a) fluid b) molten c) soluble d) runny

5. Poisons should be kept in a place that is to children.
a) impracticable b) inapplicable c) inaccessible d) unavailable
6. The medicine should be with a little water.
a) diluted b) reduced c) thinned d) weakened
7. Alcoholic drinks have a effect on many people.
a) sedate b) sedative c) sedentary d) sedimentary
8. Did you get any effects when you were taking those tablets?
a) backwash b) subsequent c) subsidiary d) side
9. Many drugs are not to the public without a doctor's prescription.
a) acceptable b) available c) permissible d) reliable
10. People who distribute drugs like heroin can have no at all.
a) conscience b) consciousness c) goodness d) moral
11. I took the doctor's prescription to the chemist's to be made
a) for b) into c) out d) up
12. It seems that medical science is of discovering a cure for cancer.
a) on the corner b) on the edge c) on the rim d) on the verge

184. HEALTH. *Choose the correct answer.*

1. The doctor asked me to to the waist.
a) bare b) strip c) take off d) undress
2. The nurse put a round Peter's bleeding knee.
a) bandage b) belt c) ribbon d) scarf
3. He had injured his arm badly and had to keep it in a for several weeks.
a) cradle b) litter c) sling d) stretcher
4. When he finally , he couldn't remember what had happened.
a) came round b) held back c) stood back d) wore off
5. The doctor told her that her temperature was
a) current b) familiar c) habitual d) normal
6. He is dark glasses to protect his eyes from the sun.
a) bearing b) carrying c) fitting d) wearing
7. The ambulance men took the injured climber down the mountain on
a) a bedstead b) a cot c) a couch d) a stretcher
8. Although the patient's condition is serious, she seems to be out of
a) control b) danger c) order d) place
9. If he loses consciousness, give him a sip of brandy to bring him
a) back b) over c) round d) up
10. With every he took, he got more and more tired.
a) foot b) march c) step d) walk

11. My sister works in a home for the deaf and
a) dumb b) mute c) speechless d) voiceless
12. Make sure you your food properly before you swallow it.
a) bite b) chew c) crunch d) eat
13. The fact is, doctor, I just cannot this dreadful cough.
a) get down to b) get out of c) get rid of d) get round to
14. The doctor took his temperature and felt his
a) blood b) muscle c) pulse d) vein
15. While he was in hospital, his wound was twice a day.
a) changed b) cured c) dressed d) healed
16. After a quick at the patient the doctor rang for an ambulance.
a) gaze b) glance c) glimpse d) stare
17. Apply direct on the wound to stop severe bleeding.
a) compression b) contraction c) pressure d) restriction
18. The man who was taken to hospital had been for three hours.
a) indifferent b) insensitive c) unconscious d) unfeeling
19. The injured man was taken to hospital on
a) an ambulance b) a bed c) a sling d) a stretcher
20. After any hard or prolonged exercise it is advisable to check your
a) brain waves b) eyesight c) mental balance d) pulse rate

185. HEALTH. *The following problems and pieces of advice have got all mixed up. Can you match them correctly?*

- | | |
|---|--|
| 1. I keep getting headaches. | a. Good, you needn't come back for a month. |
| 2. I can't get into my clothes. | b. You really must stop smoking. |
| 3. I can't sleep at night. | c. Perhaps you should have an eye test. |
| 4. My eyes are often sore and I sneeze a lot. | d. You ought to do more exercise — it's very relaxing. |
| 5. I'm going to Nepal on business. | e. You'll have to have a few injections. |
| 6. I've got a bad stomach. | f. You shouldn't eat so much fried food. |
| 7. I feel much better now, doctor. | g. You really must lose some weight. |
| 8. I've got a terrible cough. | h. You should have some allergy tests. |

186. HEALTH. *Choose the right answer.*

1. The doctor told me he could nothing wrong with my health.
a) bring b) find c) gain d) obtain
2. He applied for a week's to look after the children while his wife was in hospital.
a) leave b) leisure c) rest d) vacation

3. There were thirty waiting in the doctor's surgery.
a) clients b) customers c) patients d) visitors
4. The old nurse was able to her master only by the mark on his arm.
a) notice b) realise c) recognise d) remark
5. Short sight can be by the use of suitable glasses.
a) corrected b) fixed c) improved d) reduced
6. She prides herself never having had a day off sick.
a) for b) in c) of d) on
7. The patient was fit enough to and take some nourishment a few hours after the operation.
a) lie down b) lift up c) sit up d) stand up
8. You must a rest after that long walk.
a) lay b) make c) sleep d) take
9. Whenever there's a flu , doctors are kept very busy.
a) breakout b) outbreak c) outcome d) outlook
10. Can you please an appointment for me to see Dr Wilson?
a) arrange b) do c) make d) take
11. A walk in the fresh air will
a) better you b) do you good c) heal you d) make you good
12. The new form of treatment will have to be under laboratory conditions before it is applied generally.
a) controlled b) experimented c) proved d) tested
13. The of his death were highly suspicious.
a) circumstances b) conditions c) events d) indications
14. If you'd like to take a seat in the waiting room till the doctor can see you, you'll find plenty of magazines to
a) browse through b) look over c) refer to d) stare at
15. It's a good idea to see your doctor regularly for
a) a control b) a check-up c) an investigation d) a revision
16. Mary had to be taken to hospital after her
a) accident b) dilemma c) happening d) occurrence
17. The staff at the hospital were well to deal with the epidemic.
a) capable b) equal c) equipped d) ready
18. It's for you to have an immediate operation.
a) certain b) decided c) definite d) essential
19. An ambulance must have priority as it usually has to deal with some kind of
a) crash b) crisis c) emergency d) urgency

* 187. HEALTH. Choose the correct answer.

1. The patient to listen to his doctor's advice.
a) hindered b) lacked c) refused d) resigned
2. There is a for blankets and medicines in the disaster area.
a) dearth b) lack c) need d) shortage
3. The doctor gave him a examination.
a) conscientious b) methodical c) precise d) thorough
4. At midday the doctor went on his , visiting sick patients.
a) circles b) rounds c) routes d) ways
5. When my brother was in hospital, he was by a well-known surgeon.
a) carried on b) operated on c) passed on d) worked on
6. He was worried about his health, but his doctor put his mind at
a) comfort b) leisure c) rest d) sleep
7. At the casualty department my sister had her injury
a) cured b) healed c) operated d) treated
8. There was in the doctor's tone, as he spoke of his patient's recovery.
a) afraid b) anxiety c) fear d) uncertainty
9. Everyone hoped that he would after the operation.
a) get well b) pull on c) pull out d) pull over
10. Euthanasia, or killing, is a common subject for debate these days.
a) helpful b) kind c) mercy d) sympathetic
11. John, who lost a leg in a car accident, has now been fitted with limb.
a) an artificial b) an attached c) an extra d) a substitute
12. The nurse told me that Sam's immediately after his operation was satisfactory.
a) condition b) health c) situation d) state

188. HEALTH. Complete the sentences below with a preposition (from, on, with, etc.).

My wife complained that something was wrong her. She said she had a pain her back and that she suffered bad headaches. As she was getting worse and worse I sent a doctor. Immediately afterwards she was taken hospital. Yesterday she was operated Now she feels much better.

189. HEALTH. Fill in the right words.

1. I've got hayfever and that's the reason why I keep on _ _ _ _ e _ _ _ _ _ .
2. I really do not know if this medicine _ _ _ _ _ a _ _ _ _ alcohol; most medicines do.
3. As far as I know common aspirin is the best _ _ _ _ _ for your illness.

4. If the meeting is tomorrow I'll have to _____ c _____ an appointment with my dentist.
5. He is a very talented _____ g _____. All the patients on whom he has operated are in good health now.
6. While some surgeons are experimenting with transplantation of natural organs, others see the future in the use of _____ f _____ ones.
7. He asked me if he might smoke a cigarette. I am a smoker myself, so I did not _____ e _____ to it.
8. As the doctor came into the room the nurse handed him the temperature _____ r _____ of the patient.
9. He took a sleeping-tablet, but it had absolutely no _____ c _____. It was a sleepless night for him.
10. Our children seem to spend all day playing doctors and _____ n _____.
11. He slipped on the icy road, lost his _____ n _____ and fell.
12. You can't buy this medicine without a _____ r _____ from a doctor.
13. It may be dangerous to have a meal first and go for a swim immediately _____ w _____.
14. I don't feel very well. I think I'm going to be _____ c _____.
15. The psychiatrist's _____ e seems exorbitant considering the short time he spends on each patient.
16. His mother sent him to bed because he had quite a high _____ r _____.
17. He was 10 kilos overweight and was advised to go on a _____.
18. I had to wait for an hour in the doctor's _____ g _____.
19. If you want to find out someone's temperature, use a _____ r _____.
20. If you want to stay well, don't eat too much and get plenty of _____ x _____.

* 190. HEALTH. Choose the right answer.

1. The patient's condition is
a) critical b) dangerous c) hazardous d) perilous
2. Everything possible was done to the suffering of the wounded man.
a) alleviate b) console c) diminish d) pacify
3. The doctor decided it was better at that point not to the nature of the illness.
a) confess b) give up c) reveal d) unmask
4. Abortion has become a issue in recent years.
a) blazing b) burning c) fiery d) hot
5. That man will live for ever, he's
a) immature b) immoral c) immortal d) indefinite
6. We thought she was over the worst of her illness, but yesterday she had a
a) come-back b) relapse c) relaxation d) reversion
7. I could tell that she was frightened because she my arm hard.
a) bruised b) gripped c) pulled d) stretched
8. It is physically impossible for any human being to such extreme cold for long.
a) endure b) last c) persist d) withhold

9. I have been offered the appointment, to my passing a medical examination.
a) condition b) confirmatory c) dependent d) subject
10. As people get older their bodies begin to run and they have less immunity to disease.
a) down b) low c) off d) out
11. They his broken leg in plaster.
a) arranged b) fitted c) set d) tied
12. We need to be able to breathe in order to live.
a) atmosphere b) carbon dioxide c) oxygen d) ozone
13. The test that she was pregnant.
a) certified b) demonstrated c) indicated d) verified
14. According to a hospital spokesman, hopes were last night that the victim would ever regain consciousness.
a) decreasing b) fading c) growing d) increasing
15. Try something sharp-smelling under her nose, that might if she's still unconscious.
a) bring her about b) bring her to c) get her over d) put her forward
16. The recent study of has produced some interesting results showing that humans have a built-in 24-hour biological clock.
a) biographs b) biorhythms c) bioscopes d) biotypes
17. Exercising generally begins with standing up straight, slowly and then letting your breath out evenly.
a) airing b) exhaling c) ingesting d) inhaling
18. Before the group of doctors would give their opinion they wanted to with each other.
a) confer b) confess c) confirm d) confide
19. Peter was from hospital last week.
a) discharged b) dismissed c) released d) withdrawn
20. In the stomach, the protein in food is into simpler substances by the action of acids and enzymes.
a) broken down b) knocked down c) melted down d) rendered down

191. HEALTH. *Fill in the English translation of the word(s) in brackets.*

1. Diane was seriously ill some time ago. She is still weak but her health is _____ (polepszać się) rapidly and no doubt she will be all right soon.
2. I really admire him for the patience and the calm with which he _____ s (znosić) his terrible illness. I know how he must suffer.
3. His injuries are so serious that he may _____ (pozostać) an invalid for the rest of his life.
4. His eyesight is poor, so he has to wear _____ (okulary).
5. She decided not to marry and to _____ (poświęcić) her whole life to helping the mentally retarded.

6. I have recently read about a youth who _____ (uratować) four children from drowning.
7. The dentist uses a _____ (wiertło) to cut into your teeth.
8. I went to the doctor about my cough and he prescribed some _____ (tabletki do ssania).
9. It was quite a bad cut and it was bleeding, so I put on a _____ (opatrunek).
10. I hurt my wrist yesterday playing football and today it's _____ (spuchnięty).
11. I think he has fainted! Quick, someone, call an _____ (karetka pogotowia).
12. There is nothing a doctor can do about the common cold, there's no known _____ (lekarstwo).

* 192. **INJURIES.** *Your friend has a few marks on his body. Match the name of the mark with the explanation of its origin.*

- | | |
|------------------------------|-----------------------------|
| 1. This BITE on my leg | 6. This SCAR on my belly |
| 2. These BLISTERS on my feet | 7. This SCRATCH on my arm |
| 3. This BRUISE on my eyelid | 8. These SPOTS on my cheeks |
| 4. This CUT on my thumb | 9. This STING on my chin |
| 5. This GRAZE on my knee | |

- a. I got when I was operated on for appendicitis.
- b. I got when I went on a walking tour in too tight shoes.
- c. I got when I was hit by my friend during our quarrel.
- d. I got when I fell down while running.
- e. I got when I suffered from measles.
- f. I got when I was cutting onions with a sharp knife.
- g. I got when I was attacked by a fierce dog.
- h. I got when I was playing with my cat.
- i. I got when I went to take some honey from the beehive.

* 193. **INJURIES.** *Choose the correct answer.*

1. He got that on his forehead when he ran into an open cupboard door in the dark a few days ago.
a) blister b) bruise c) scar d) sprain
2. Mary was by a wasp while she was gathering some pears.
a) bitten b) eaten c) stung d) wounded
3. Be careful you don't yourself when you are cutting those roses.
a) pick b) prick c) sting d) wound

4. I fell off my bicycle when I was five and I still have a on my knee.
a) freckle b) scar c) hole d) scratch
5. He got a terrible on the head when he forgot to bend as he went through the low doorway.
a) bump b) hunch c) ripple d) wrinkle
6. This dates from my operation last year.
a) cut b) scar c) scratch d) sore
7. A sword will only draw blood if it actually the skin.
a) pierces b) pricks c) plunges d) thrusts
8. I have a on my leg where you hit me.
a) blister b) bruise c) hole d) wound
9. She cried so much that her face became
a) fat b) soft c) swollen d) torn
10. If you are so senseless as to go on long walks in tight-fitting shoes, you must expect to get
a) blisters b) bruises c) scars d) scratches

*** 194. INJURIES. Crossword puzzle.**

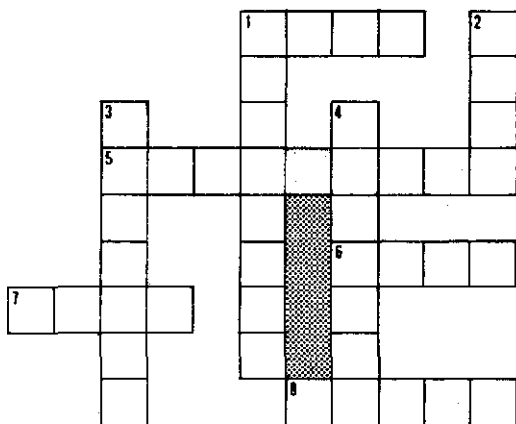

ACROSS:

1. from an old wound (4)
5. painful swelling on the hand or foot caused by exposure to cold (9)
6. small mark in the skin, possibly caused by an illness such as measles (4)
7. from dog's teeth (4)
8. on the knee (5)

DOWN:

1. often the result of a toothache or sprained ankle (8)
2. hard skin, often on the foot (4)
3. from cat's claws (7)
4. from walking in too tight shoes (7)

195. INJURIES. *Choose the correct answer.*

1. Fortunately, nobody was in the accident.
a) broken b) damaged c) injured d) wounded
2. He tripped in a pot-hole and his ankle.
a) slid b) slipped c) sprained d) stressed
3. I have broken my new glasses and I can't find my old
a) couple b) double c) one d) pair
4. He had to go to hospital when he
a) broke up b) broke his muscle c) had a break d) pulled a muscle
5. As a result of his accident, Peter will have to have leg.
a) an artificial b) a manufactured c) a substitute d) a secondary
6. For a long time after the accident, she suffered from constant in her back.
a) ache b) hurt c) injury d) pain
7. The music at modern discos is so loud that it can cause among teenagers.
a) blindness b) deafness c) dumbness d) unconsciousness
8. In spite of the number of cars involved in the accident, there was only one — a man with a broken hand.
a) case b) casualty c) injury d) patient
9. The electrician got a from the faulty wiring.
a) blow b) jump c) shock d) start
10. Apparently about one person in five is left
a) handed b) hander c) handful d) handy
11. Two of the drivers in the car crash had multiple
a) accidents b) casualties c) damages d) injuries
12. I was doing some weeding in the garden when suddenly my back
a) collapsed b) failed c) sprained d) went
13. He got out of bed and took a few but couldn't go any farther.
a) actions b) stages c) starts d) steps
14. The man was very as he had injured his leg badly when he was a boy.
a) blind b) deaf c) lame d) limp
15. The man's face was from his infected tooth.
a) bulging b) dilated c) expanded d) swollen
16. In the accident, several people were
a) crushed b) damaged c) hurt d) wounded
17. He hurt his knee early in the game, and off the field.
a) carried b) left c) limped d) trod
18. The in his leg was so terrible he thought he would go mad.
a) bruise b) disease c) illness d) pain
19. The woman tripped over the uneven pavement and her elbow.
a) disabled b) dislocated c) dislodged d) distorted
20. Since his motor-accident, he has been in one leg.
a) cracked b) crazy c) irregular d) lame

*** 196. INJURIES.** *Choose the right answer.*

1. I think I've got a of dust in my eye. Can you see it?
a) grain b) sliver c) speck d) splinter
2. She and fell from the top of the stairs to the bottom.
a) slipped b) sloped c) spilt d) split
3. While the children were playing on the beach, Peter on a broken bottle and cut his foot rather badly.
a) came b) ran c) tripped d) trod
4. Mr Jackson is permanently as the result of a car accident.
a) disabled b) inactive c) incapable d) powerless
5. He was hit by a bullet but luckily he was only wounded.
a) barely b) little c) merely d) slightly
6. John slipped as he was walking beside the river, and fell into the water with a loud
a) bang b) crash c) splash d) trickle
7. The patient was found to be suffering from injuries as a result of his fall.
a) multifarious b) multiple c) multipliable d) multiplied
8. I didn't notice the log on the ground and over it.
a) crept b) crushed c) skipped d) stumbled
9. The sudden noise made me
a) frighten b) jump c) shudder d) startle
10. John slipped on a piece of orange and broke his leg.
a) crust b) coat c) peel d) shell

197. MENTAL HEALTH. *Choose the correct answer.*

1. His mother's illness had placed him under a considerable
a) strain b) stress c) tension d) worry
2. He sat all day silently watching the fire and seemed to have no at all left in him.
a) action b) life c) mind d) movement
3. He has a medical full of nervous trouble.
a) ancestry b) history c) story d) tree
4. "Deep breathing will help you down," the doctor advised.
a) calm b) relax c) remain d) rest
5. Robert has suffered from epileptic ever since his accident.
a) disorders b) disturbances c) falls d) fits
6. Anyone would lose their living with that madman.
a) brain b) brains c) health d) sanity
7. The doctors say he'll take a long time to get the shock.
a) above b) over c) past d) through

8. As she is so heavily overworked, there is a possibility that she will have a nervous breakdown.
a) distinct b) little c) manifest d) tiny
9. Some psychiatrists argue that, in the final parents are to blame for their children's behaviour.
a) analysis b) case c) collapse d) experiment
10. He showed signs of mental disturbance so they sent him to a hospital.
a) brain b) lunatic c) psychiatric d) psychological
11. is one of the most important factors when giving first aid.
a) Boldness b) Courage c) Conviction d) Reassurance
12. What's the matter with you? You look as if you had seen a
a) ghost b) horror c) monster d) tragedy

*** 198. MENTAL HEALTH. Choose the right answer.**

1. He suffered a nervous and was obliged to rest for several months.
a) break-down b) drop-out c) fall-out d) knock-out
2. Every day in the hospital was the same and the got on Peter's nerves.
a) comparison b) monotony c) same d) similarity
3. Working with the mentally handicapped requires considerable of patience and understanding.
a) means b) provisions c) resources d) stocks
4. After the accident, his thinking seemed to be somewhat
a) confusing b) muddled c) ordered d) sane
5. His memory has become very lately.
a) infallible b) insecure c) precarious d) unreliable
6. The patient complained that no doctor really just how ill he was.
a) appreciated b) comprehended c) judged d) regarded
7. Psychic people claim to possess highly-developed powers of extra- perception.
a) sense b) sensitive c) sensory d) sensuous
8. He feels slightly but this is a common after-effect of influenza.
a) dejected b) depressed c) deprived d) oppressed
9. My nerves are totally
a) burst b) cracked c) demolished d) shattered
10. Yoga is very beneficial for people who suffer from emotional as it helps them gain an inner peace.
a) havoc b) knock-out c) stress d) violence
11. If people are deprived of dreaming during sleep they begin to show signs of mental
a) decay b) deficiency c) derangement d) subnormality

199. PATIENTS. *Choose the right answer.*

1. After her illness, it took her a month to her normal strength.
a) receive b) refresh c) regain d) return
2. My brother received an ankle injury last week and will not be for tomorrow's match.
a) conditioned b) fit c) healthy d) suitable
3. Betty is almost well again now, but she still looks rather
a) faded b) light c) pale d) poor
4. Bitterly cold grey weather together with the after-effects of influenza made her feel very
a) bored b) depressed c) disgusted d) worried
5. His long illness left him so that he had to spend four months regaining his strength before he could go back to work.
a) decreased b) invalid c) unhealthy d) weak
6. My grandma is not very well, in fact, we are rather about her.
a) anxious b) careful c) troublesome d) urgent
7. We realised that he was under great because of his wife's illness.
a) crisis b) excitement c) nervousness d) strain
8. The patient was to hear that he had not broken his leg.
a) reconciled b) refreshed c) relaxed d) relieved
9. My son is ill so I must go home and look him.
a) about b) after c) for d) towards
10. My grandfather's condition got worse during the cold weather.
a) evenly b) firmly c) steadily d) smoothly
11. Sarah looks of her former self since her long illness.
a) an illusion b) an image c) a shade d) a shadow
12. Children usually pick after an illness much more quickly than adults.
a) off b) on c) over d) up
13. The main purpose in keeping fit is to feel more pleasure in being
a) alive b) conscious c) live d) lively
14. I heard she was ill, so I to see her.
a) came there b) came c) went out d) went round
15. She had a lot of before the operation.
a) ache b) hurt c) ill d) pain
16. The doctor advised me to take a(n) rest for a few weeks.
a) absolute b) complete c) full d) total
17. Has John got his illness yet?
a) at b) out of c) over d) up
18. Pensions are given to people who lose in industrial accidents.
a) arms b) heads c) limbs d) pieces

19. My sister is not very strong and is often ill. Her health is very
 a) delicate b) sick c) slim d) unwell
20. It was a long illness, with months of treatment, but he recovered.
 a) after a time b) at a time c) in time d) on time
21. The man looked very pale as he had lost a lot of in the accident.
 a) blood b) body c) bone d) skin
22. A week after the operation he was from hospital.
 a) discharged b) freed c) liberated d) released
23. The doctor has told him that he must not go back to work so soon after such a long

 a) disease b) failing c) illness d) weakness
24. I don't like the look of her She doesn't look right.
 a) appearance b) attitude c) personality d) qualifications
25. As I felt so much better, my doctor me to take a holiday by the sea.
 a) accepted b) advised c) considered d) suggested

*** 200. PATIENTS.** *Choose the right answer.*

1. She was that we could go and see her in hospital.
 a) anxious b) concerned c) delighted d) mad
2. The woman was in a emotional state after hearing of her son's accident.
 a) doubtfully b) greatly c) highly d) largely
3. She didn't seem to know what was happening at all, she looked completely
 a) bewildered b) doomed c) doubtful d) undecided
4. We're sorry you are ill and send you our best wishes for a speedy
 a) recovery b) relief c) repair d) survival
5. She will never be able to the winters in Poland because of her health.
 a) repulse b) resist c) stand d) sustain
6. Sam is in hospital again. The poor chap seems accidents
 a) bound b) destined c) disposed d) prone
7. After her long illness she looked quite
 a) elevated b) emaciated c) emancipated d) emasculated
8. He's been very ill but we think he'll it.
 a) come back b) get over c) pull through d) take off

*** 201. PATIENTS.** *Choose the right answer.*

1. Don't ask me anywhere. Since my operation I am not going out.
a) able to b) in for c) up to d) willing to
2. If you've got a bad cold, it's no wonder you're
a) on form b) out of order c) out of sort d) under the weather
3. His doctor warned him to it easy for a few months and relax.
a) exist b) live c) pass d) take
4. You know that smoking always brings a fit of coughing.
a) in b) on c) out d) up
5. I think I need a holiday. I have been feeling rather lately.
a) below standard b) downcast c) off colour d) under strength
6. He took the pills and a week later he was as right as
a) dawn b) rain c) sunshine d) water
7. Poor old man! He has one foot in the
a) bath b) door c) grave d) shoe
8. Sue looks the picture of since she returned from her holiday.
a) health b) wealth c) well-being d) wholesomeness
9. After a month in the sunshine she was well on the to recovery.
a) avenue b) direction c) road d) route
10. The patient recovered from his operation
a) by bits and pieces b) by degrees c) gradual d) in bits and pieces
11. A few months after her successful operation she felt on top of the
a) earth b) land c) sky d) world
12. After your treatment, doc, I felt as as a fiddle.
a) fine b) fit c) straight d) well

202. SMOKING. *Choose the right answer.*

1. Smoking is a dirty
a) custom b) fashion c) habit d) manner
2. You will die of lung cancer if you in smoking so many cigarettes.
a) assist b) consist c) insist d) persist
3. It is well-known that smoking can do you great
a) damage b) danger c) harm d) trouble
4. His doctor advised him to himself to three cigarettes a day.
a) border b) cage c) keep d) limit
5. Heavy smokers are twenty-five times more likely to be by lung cancer than non-smokers.
a) attacked b) gripped c) stricken d) taken
6. I used to be quite a smoker, but I gave it up several years ago.
a) bad b) frequent c) heavy d) strong

7. Smoking is a very bad habit, which many people find difficult to
a) beat b) break c) breathe d) cough
8. Can you me an effective way to stop smoking?
a) advise b) instruct c) show d) suggest
9. All cigarette packets carry about the effect of smoking on health.
a) an advice b) an alarm c) an alert d) a warning
10. It has been conclusively that smoking causes many diseases.
a) admitted b) approved c) declared d) established
11. Experts have found that breathing in tobacco smoke can be to non-smokers.
a) harmful b) spoiling c) unhealthy d) wholesome
12. He never stops smoking; one cigarette after another. I'm afraid he's become a smoker.
a) chain b) cord c) line d) rope
13. You have a very nasty cough. You must on cigarettes.
a) cut down b) give up c) reduce d) take down
14. I hope you don't to my smoking.
a) disapprove b) disagree c) object d) oppose
15. Many people have smoking. Why don't you follow their example!
a) ended b) given up c) gone from d) left

203. SPECIALISTS. *Where can you find these patients? Match the patients with the correct wards or departments.*

1. Intensive Care Unit
 2. Casualty and Emergency Department
 3. Paediatric Ward
 4. Maternity Unit
 5. Orthopaedic Ward
 6. Surgical Ward
 7. Geriatric Ward
 8. Ophthalmic Ward
 9. Gynaecological Ward
- a. Mary who has just had a baby
 - b. John who has broken his leg
 - c. My grandmother who is suffering from pneumonia complications
 - d. Peter who will have his appendix removed
 - e. Betty's mother who is suffering from women's disease
 - f. My mother who will be operated on for an eye cataract
 - g. Samuel who is unconscious
 - h. Paul who has just been in a car crash
 - i. Your son who has measles

204. SPECIALISTS. Give the name of the persons defined below.

1. a family doctor g _ _ _ _ _ p _ _ _ _ _ er
2. someone who looks after sick people in hospital _ _ _ _ _ s _ _
3. sick person who has to stay in hospital i _ - _ _ _ _ _ _ _
4. sick person who has to visit hospital regularly for treatment o _ _ _ - _ _ _ _ _ _ _
5. someone who operates on sick people _ _ _ _ _ o _ _
6. person badly injured in an accident, fire, war _ _ a _ _ _ _ _ _ _
7. person who helps at the birth of a baby m _ _ _ _ _ _ _
8. person who specializes in one area of medicine _ _ p _ _ _ _ _ _ _ _

****205. SPECIALISTS.** Some of these words look so much alike that we often confuse them. See if you can get them straight. Here are some specialists with brief descriptions of their specialties. Check the one correct title that fits the description in each case.

1. He treats children's diseases.
 - a. He is an orthopaedist.
 - b. He is a pediatrician.
 - c. He is a pathologist.
2. He corrects deformities of the body.
 - a. He is a gynaecologist.
 - b. He is an orthopaedist.
 - c. He is a pathologist.
3. He straightens crooked teeth.
 - a. He is an orthodontist.
 - b. He is an orthopaedist.
 - c. He is a pathologist.
4. He is a medical doctor who specializes in diseases of the eye.
 - a. He is an oculist.
 - b. He is an optician.
 - c. He is an orthopaedist.
5. He makes your eyeglasses.
 - a. He is an oculist.
 - b. He is an orthopaedist.
 - c. He is an optician.
6. He specializes in disorders of the mind.
 - a. He is an intern.
 - b. He is a psychiatrist.
 - c. He is a physiotherapist.
7. He treats diseases by electricity.
 - a. He is a pathologist.
 - b. He is a physiotherapist.
 - c. He is a psychologist.

8. His specialty is taking and interpreting X rays.
 - a. He is a gynaecologist.
 - b. He is a neurologist.
 - c. He is a radiologist.
9. He specializes in diseases of the nervous system.
 - a. He is a cardiologist.
 - b. He is a dermatologist.
 - c. He is a neurologist.
10. He treats diseases of old age.
 - a. He is a cardiologist.
 - b. He is a geriatrician.
 - c. He is a pediatrician.
11. He specializes in skin diseases.
 - a. He is a dermatologist.
 - b. He is a geriatrician.
 - c. He is a pathologist.
12. He treats women's diseases.
 - a. He is a dermatologist.
 - b. He is a geriatrician.
 - c. He is a gynaecologist.
13. He brings children into the world.
 - a. He is a gynaecologist.
 - b. He is an obstetrician.
 - c. He is a pediatrician.

**** 206. SPECIALISTS.** Which of the professionals would you consult in each of the following cases?

- | | |
|--|---------------|
| 1. To operate on an eye cataract | _____ c _____ |
| 2. To cure your son's measles | _____ d _____ |
| 3. To make your new glasses | _____ i _____ |
| 4. To deliver a baby | ob _____ |
| 5. To test your eyesight | _____ t _____ |
| 6. To cure a rash on the skin | d _____ |
| 7. To treat a sick mind | p _____ |
| 8. To operate on your appendix | _____ r _____ |
| 9. To examine the old-age complaints of your grandmother | g _____ |
| 10. To treat Peter's deformed hip | _____ p _____ |
| 11. To analyze your dreams | _____ s _____ |
| 12. To treat the ailments of your wife | _____ n _____ |

**** 207. SPECIALISTS.** *What is the difference between a psychiatrist and a psychoanalyst?*

208. SYMPTOMS. *Match the symptoms with the explanation what caused them.*

- | | |
|---------------------------|---|
| 1. Why are you sneezing? | a. I'm terrified by this story. |
| 2. Why are you crying? | b. I've cut myself with a bread-knife. |
| 3. Why are you yawning? | c. I'm bored with this lecture. |
| 4. Why are you coughing? | d. Cigarette smoke irritates my throat. |
| 5. Why are you bleeding? | e. You are hurting me. |
| 6. Why are you sweating? | f. I have a bad cold. |
| 7. Why are you shivering? | g. I'm very cold. |
| 8. Why are you shaking? | h. I must have eaten some bad food. |
| 9. Why are you vomiting? | i. It's too warm in here. |

**** 209. SYMPTOMS.** *Match the following symptoms of disease with their definitions.*

- | | |
|------------------|--|
| 1. belching | a. difficult or infrequent emptying of the bowels |
| 2. colic | b. weariness from bodily or mental exertion |
| 3. constipation | c. to become senseless and motionless |
| 4. cramp | d. feeling as if everything were turning round |
| 5. diarrhea | e. act of sending out gas from the stomach noisily through the mouth |
| 6. dizziness | f. a burning sensation in the stomach from indigestion |
| 7. faint | g. pain in a nerve |
| 8. fatigue | h. feeling of sickness as caused by bad food |
| 9. fever | i. yellowness of the skin and the whites of the eyes |
| 10. heartburn | j. inability to sleep |
| 11. hiccups | k. a sensation in the skin causing a desire to scratch |
| 12. indigestion | l. the soft yellowish substance formed in and coming out from a poisoned place in the body |
| 13. inflammation | m. patch of tiny red spots on the skin |
| 14. insomnia | n. severe pain in the stomach and bowels |
| 15. itch | o. too frequent and too watery emptying of the bowels |
| 16. jaundice | p. sudden and painful tightening of the muscles |
| 17. nausea | r. condition of the body with temperature higher than usual |
| 18. neuralgia | s. a spasm of the respiratory muscles |
| 19. pus | t. a redness and swelling attended with heat, pain |
| 20. rash | u. difficulty in digesting food |

**** 210. SYMPTOMS.** *Give the Polish names of the symptoms in the above exercise.*

**** 211. SYMPTOMS.** Choose words from the group below to complete the sentences. It may be necessary to change the form of the given words.

dizzy feverish queasy rash runny seedy sore
swollen to cough to vomit

1. I haven't taken her temperature yet but her face is flushed and she seems
2. It's hard to describe. I just feel generally Can you prescribe a tonic?
3. When I stand up the room seems to be going round. I feel really
4. I'm not in pain but the glands in my neck seem to be
5. I've got a tickle in my throat. I can't stop
6. I feel a bit queasy. I think I'm going to
7. I've come out in a all over my chest and arms. I think I may be allergic to strawberries.
8. It's like being sea-sick. I feel whenever I move about.
9. My throat is awfully I hope it's not another bout of tonsilitis.
10. I've got a nose. I suppose it's a cold coming on.

*** 212. SYMPTOMS.** Choose the correct answers.

1. You should put your hand in front of your mouth when you
a) sniff b) snore c) swallow d) yawn
2. Six people were overcome by from a container in the laboratory.
a) fumes b) leaks c) odours d) outflows
3. She has been working so hard she feels quite
a) careful b) dull c) exhausted d) wasted
4. The dog was in a terrible when we found it.
a) condition b) danger c) illness d) sickness
5. His illness made him of concentration.
a) incapable b) incompetent c) powerless d) unable
6. I felt a sharp when I put my hand in the boiling water.
a) ache b) harm c) pain d) suffer
7. If you have got measles, your body is covered in
a) blots b) dots c) freckles d) spots
8. Every time she eats shellfish, she comes out in
a) a blush b) a bruise c) an itch d) a rash
9. The baby is very fretful: he must be some teeth.
a) cutting b) grinding c) making d) producing
10. There is a small hard on my wrist. I think I'd better see the doctor.
a) bruise b) lump c) rash d) swelling
11. I have a bad cold, and have lost all of smell.
a) degree b) scent c) sense d) skill

12. He from rheumatism.
a) hurts b) pains c) suffers d) troubles
13. Women seem able to pain better than men.
a) bear b) carry c) support d) wear
14. I couldn't go to the party because of a cold.
a) fast b) hurried c) sudden d) surprising
15. He fell heavily and was immediately conscious of pain in his right arm.
a) acute b) hard c) raw d) strong
16. Left on his back, an unconscious casualty may in his own vomit.
a) drown b) sink c) submerge d) suffocate
17. I have a headache.
a) burning b) raving c) spitting d) splitting
18. Her sister's kept me awake for half the night.
a) blowing b) coughing c) flowing d) swallowing
19. His stomach began to because of the bad food he had eaten.
a) ache b) be hurt c) harm d) pain
20. You can die from breathing the from a car engine for too long.
a) air b) fumes c) smoke d) steam
21. He says he has got in his stomach.
a) aches b) hurt c) pains d) suffering
22. I've got such a throat I'm sure I must be going to have a cold.
a) hurt b) irritable c) sensitive d) sore
23. I think you should see a doctor about that
a) belch b) blister c) inflammation d) pimple
24. I'm not really ill, but I have a headache.
a) delicate b) pale c) slight d) weak
25. Colour-blind people often find it difficult to between blue and green.
a) compare b) contrast c) distinguish d) separate

213. SYMPTOMS. *Choose the right answer.*

1. When I tried to walk I had a sharp in my leg.
a) cut b) hurt c) pain d) wound
2. Whenever she catches a cold, she gets a all over her face.
a) blemish b) lump c) rash d) sore
3. She of severe pains in her arms and legs.
a) complains b) grumbles c) remarks d) says
4. You're looking very pale — do you sick?
a) become b) fall c) faint d) feel

5. My husband does not feel at all well. I think he must have eaten something that with him.
a) disagreed b) disturbed c) hurt d) poisoned
6. If you have a sore throat it is very difficult to
a) bite b) chew c) digest d) swallow
7. If you didn't keep scratching that spot on your face, it would soon
a) cure b) heal c) mend d) remedy
8. When I took his temperature, it was two degrees above
a) normal b) ordinary c) regular d) usual
9. I was so tired I couldn't stop
a) coughing b) crying c) laughing d) yawning
10. After the accident she suffered brain and couldn't speak.
a) damage b) decay c) destruction d) disease
11. The child who swallowed a peanut began to
a) breathe b) choke c) cough d) yawn
12. May I please have a glass of water? I feel a little
a) bad b) faint c) hungry d) ill

214. SYMPTOMS. *Choose the correct form.*

The clinical thermometer is used (for, to) measuring (body's, body) temperature. It (consists of, contains, includes) a tube made (from, of, with) glass, which (comprises, contains, consists of) a certain (amount, number) of mercury. When the mercury is (hot, heated), it (expands, extends, increases) and (raises, rises) up the tube, which is graduated in degrees Fahrenheit or Centigrade (according, depending) on the country of manufacture.

*** 215. SYMPTOMS.** *Choose the correct form.*

1. The dying man said nothing: he merely
a) mumbled b) sighed c) stammered d) whispered
2. There is something wrong with his vocal chords and, as a result, he has always been
a) deaf b) dumb c) silent d) speechless
3. He suffers from a speech and so he cannot pronounce the letter "r" correctly.
a) break b) defect c) error d) mistake
4. She had lost her voice and could only speak in a
a) breath b) rustle c) whisper d) whistle
5. After speaking for two hours, the lecturer found he could scarcely talk, as he had become
a) dumb b) hoarse c) inarticulate d) speechless

6. When he spoke on the telephone, his voice was so that I could hardly hear him.
a) dim b) dull c) faint d) unnoticeable
7. You will find John rather difficult to understand at first, as he has a slight in his speech.
a) complication b) contraction c) difficulty d) impediment
8. You will have to , Aunt Betty is rather deaf.
a) call up b) ring up c) speak up d) stand up
9. After a fall from a horse, his speech became rather
a) anxious b) confused c) confusing d) clear
10. I'm afraid I'm rather of hearing. Will you speak a little louder, please?
a) deaf b) hard c) quiet d) slow
11. His stomach felt very after that rough journey in a lorry.
a) disused b) undone c) used up d) upset
12. It was so cold my fingers were quite
a) insensible b) numb c) paralysed d) senseless
13. Although the injured driver was almost unconscious, he was in pain.
a) moaning b) mumbling c) stammering d) whispering
14. He was so cold that his teeth were
a) chattering b) perishing c) shivering d) shuddering
15. He over the body of a cat lying on the pavement.
a) crashed b) stumbled c) toppled d) tumbled
16. John broke his leg. That is why he still a little.
a) halts b) limps c) staggers d) trips
17. I was by the gas in the room and fell to the ground.
a) depressed b) overcome c) overturned d) submerged
18. Her right eye when she is anxious.
a) twiddles b) twirls c) twitches d) twists
19. I have got such a headache that I can't concentrate on the lecture.
a) beating b) drumming c) hammering d) throbbing
20. He had a terrible cold and found it difficult to breathe as his nose was
a) closed up b) filled up c) shut up d) stuffed up
21. The fumes were so thick that he was for breath.
a) gasping b) inhaling c) suffocating d) wheezing
22. Go straight to the hospital and have your hand attended to — it looks to me.
a) affected b) infected c) intoxicated d) polluted

X. History

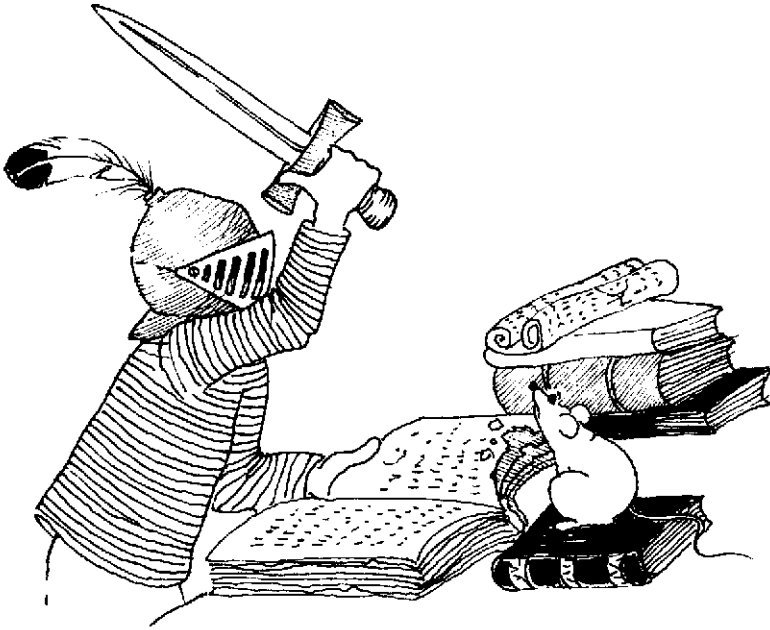

Teacher: "Tommy, who was Anne Boleyn?"

Tommy: "She was a flat-iron."

Teacher: "What on earth do you mean?"

Tommy: "Well, it says here in the history book 'Henry VIII, having disposed of Catherine of Aragon, pressed his suit with Anne Boleyn'."

*

A boy was asked by his history teacher to tell the story of Queen Elizabeth and Sir Walter Raleigh.

"Well," said the modern boy, "the queen was hopping out of her taxi, and Sir Walter spread his raincoat in front of her and said: 'Step on it, baby'."

216. HISTORY. *Choose the correct answer.*

1. The cathedral was very carefully last century.
a) mended b) redone c) replaced d) restored
2. That vase is very old and valuable; please it carefully.
a) drop b) handle c) place d) treat
3. We managed to catch a of the Queen as the procession passed.
a) glance b) glimpse c) sight d) view
4. This coin was to celebrate the victory at Trafalgar.
a) forged b) minted c) moulded d) spent
5. Legend it that Robin Hood fired an arrow from his death-bed and was buried where the arrow landed.
a) does b) has c) says d) tells
6. The Wawel museum has a collection of magnificent tapestries in the sixteenth century.
a) knitted b) sewn c) threaded d) woven
7. Sir Winston Churchill was a of my uncle's when they both studied at the Royal Military College at Sandhurst.
a) colleague b) confederate c) fellow d) partner
8. Many Indians in North America live in tribal
a) compounds b) enclosures c) reservations d) reserves
9. Many of the earliest to North America established large plantations.
a) emigrants b) entrants c) exiles d) immigrants
10. Kościuszko used to live in that house. A on the wall commemorates this.
a) badge b) medal c) plaque d) shield
11. War destroys everything and should be at all costs.
a) avoided b) conquered c) defeated d) ignored
12. The Sussex downs are part of the English national
a) ancestry b) heritage c) inheritance d) tradition
13. Papermaking began in China and from there it to North Africa and Europe.
a) flew b) flowed c) sprang d) spread
14. I have been tracing my family history and I have discovered that one of my fought on the Polish side in the Battle of Tannenberg in 1410.
a) ancestors b) descendants c) forerunners d) predecessors
15. This kind of pottery is to certain tribes in the Pacific islands.
a) characteristic b) distinctive c) peculiar d) uncommon
16. This book gives a brief of the history of the castle and gives details of the art collection in the main hall.
a) article b) outline c) reference d) research
17. The first English dictionary was by Dr Johnson.
a) collected b) compiled c) composed d) constructed

18. No one was able to explain the of the old custom.
a) beginning b) origin c) reason d) starting point
19. The first American were frequently attacked by Indians.
a) colonizers b) discoverers c) pioneers d) settlers
20. The ink on the old manuscript had faded with time and so parts of the text were
a) illegible b) illegitimate c) illiterate d) inedible
21. According to Darwin, man is from the apes.
a) descended b) elevated c) originated d) spread
22. The conspirators were planning the of the Government.
a) demolition b) disaster c) overthrow d) withdrawal
23. The King was obliged to , and a republic was proclaimed.
a) abdicate b) die c) renounce d) vacate
24. Old sailing ships usually had a of a woman on the prow.
a) face-lift b) feature c) figurehead d) frontispiece

*** 217. HISTORY.** *Fill in the blanks using the words from the list below.*

ancestors	anthem	chronicles	civilizations	curator
excavating	historic	historical	invention	manuscripts
orb	origin	posterity	prehistoric	remains
sceptre	treasure			

1. Archeologists are a tomb in Central Asia which is said to be over 20,000 years old.
2. Prior to the of the steam engine, most forms of transport were horsedrawn.
3. The ancient of Greece and Rome still have a lot to teach us today.
4. The ancient regalia of our state, namely the crown, the and the , are kept in the National Museum.
5. Any event that is recorded by history is an event.
6. The standing stones at Stonehenge date back to times.
7. Many details of life in the past are recorded in and hand-written never as yet published.
8. Both sides in the war claimed they had right on their side — will decide who was right.
9. One of my , who lived in the XVIIth century, was related by marriage to the Scottish kings.
10. Archeologists are examining the of a Roman temple near our town.
11. An important event, such as the outbreak of WW II, is a event.
12. What do you know about the of the Polish national “Mazurek Dąbrowskiego”?
Do you know who composed it and when?
13. Sometimes gold coins and other can be found in wrecked ships.
14. The museum wishes to appoint an assistant for its Renaissance collection.

218. HISTORY. *Fill in the blanks with the following words. You may use each word only once.*

ancient	chronology	date	different	discovery
dividing	Egyptians	emphasis	Empire	era
events	fall	Far East	historians	history
increasing	Japan	mark	medieval	modern
neglect	periods	round	scholars	science
western				

Divisions of History

The of dividing time into and of giving dates to historical is called History is generally divided into three periods, , medieval, and

Ancient history usually begins with the story of the , Summerians, Babylonians, and Assyrians. From there it moves on to a study of the Hebrews and Phoenicians, and the Persian It then shifts its to the west, and deals with Greece, Carthage, and Rome. For a long time, historians tended to the Far East, but historians now place emphasis on the histories of China, , India and other countries of the

No one exactly knows where ancient ought to end. used to agree on the A.D. 476, which was supposed to the fall of the Roman Empire. We now know that Rome did not suddenly "fall" and that life in 477 was not much from life in 475. But the end is usually given as about 400 or 500 A.D.

Some historians end the period with the of the Byzantine Empire in 1453. Others run the date up to 1492, so that they can start the modern with the of America. Since there is really no sharp line, many prefer to begin the modern period with the number 1500.

219. HISTORY. *Choose the correct answer.*

1. During Queen Elizabeth I's , England's role in the world changed dramatically.
a) coronation b) monarchy c) reign d) ruling
2. I can't quite make out the at the bottom of the manuscript.
a) subscription b) signal c) signature d) signing
3. There is a memorial in the church commemorating the soldiers who fell in the last war.
a) block b) grave c) stone d) tile
4. The Second World War in 1939.
a) broke off b) broke out c) broke open d) broke up
5. You need a special to go into this part of the castle.
a) agreement b) allowance c) permission d) permit
6. The vase is definitely not ; just a very good imitation.
a) factual b) genuine c) real d) true
7. The prince power on the death of his father.
a) assumed b) consumed c) presumed d) resumed

8. The king had no on any disloyal subject.
a) allowance b) forgiveness c) mercy d) sympathy
9. The curator of the archives was most and actually let me examine the ancient manuscript.
a) favourable b) gratifying c) obliging d) promising
10. The culture of minorities living in any society must be respected.
a) national b) native c) racial d) tribal
11. After the news of the victory, the people lit in the streets and danced round them all night.
a) beacons b) bonfires c) furnaces d) illuminations
12. Queen Elizabeth II her father as reigning monarch in 1952.
a) acceded b) assumed c) succeeded d) superseded
13. There are some very beautiful glass windows in Canterbury Cathedral.
a) designed b) drawn c) marked d) stained
14. The statue in the city square the soldiers who lost their lives in WW II.
a) celebrates b) commemorates c) remembers d) reminds
15. Hamlet thought he saw his father's
a) ghost b) illusion c) soul d) vision
16. Lovers have their names on this old statue for hundreds of years.
a) carved b) chopped c) outlined d) printed
17. Prof. Ancient is an authority on architecture.
a) antiquarian b) archaic c) mediaeval d) middle-aged
18. Claudius remained in until the year 54 A.D.
a) energy b) force c) power d) strength
19. Ms Curious is doing into the spread of Mesopotamian culture.
a) an examination b) a poll c) research d) a survey
20. The of the "Anna Maria" is only a few yards from the beach, and we swam out to it yesterday.
a) remains b) rest c) ruin d) wreck
21. The ambassador presented his to the Queen.
a) credentials b) depositions c) documentations d) references
22. The Union Jack is the national of Great Britain.
a) emblem b) flag c) motto d) standard
23. Archeologists are going to that site in the hope of finding Roman remains.
a) examine b) excavate c) exhume d) explore
24. In a multi-racial society, it is important to preserve the culture of its members.
a) biological b) ethnic c) national d) tribal

220. HISTORY. Fill in the blanks with the following words. You may use each word only once.

church	Death	defeated	explorer	fought
influence	invasion	invented	monk	paintings
population	printing	Reformation	Roses	Schism
ships	stake	Theses	treaties	victory
voyage	war	writings		

Events of the Renaissance

- c. 1300 The Renaissance began in Italy with Giotto's and by Petrarch and Boccaccio.
- 1334—1351 The Black swept across Europe, destroying about a quarter of the
- 1337—1453 France and England the Hundred Years', a series of wars broken by truces and
- It began with the English of Normandy. The English won the battles of Crecy, Poitiers, and Agincourt, but the French them at Orleans, and finally drove them out of France.
- 1378—1417 The Great divided the Roman Catholic Church. Two popes, one Italian and one French, claimed control of the
- 1429 Joan of Arc led the French to over the English in the Battle of Orleans. Later, the English burned her at the in Rouen.
- c. 1440 Johannes Gutenberg, a German printer, movable type for
- c. 1485 England came under the of the Renaissance after the Wars of the, which ended in 1485.
- 1517 Martin Luther, a German, began the Protestant in Germany when he nailed his Ninety-Five to the door of All Saints' Church in Wittenberg.
- 1519—1522 Spanish made the first around the world. Ferdinand Magellan, the Portuguese navigator and commanded the voyage.

221. HISTORY. Choose the one word or phrase that best keeps the meaning of the original sentence if it is substituted for the capitalized word or phrase.

- At the battle of Waterloo, Napoleon's forces **RETREATED**.
 - attacked
 - intercepted
 - pursued
 - withdrew
- Defined most **BROADLY**, folklore includes all the customs, beliefs and traditions that people have handed down from generation to generation.
 - dryly
 - fancifully
 - librally
 - quaintly

3. Embroidery **DEPICTING** scenic views became popular especially towards the **end of the eighteenth century**.
 - a) commemorating
 - b) distorting
 - c) emphasizing
 - d) portraying
4. Salt has been a respected **COMMODITY** for much of recorded time.
 - a) article of trade
 - b) flavouring
 - c) preservative
 - d) remedy for illness
5. During her husband's presidency, Jacqueline Kennedy **UNDERTOOK** the co-ordination of the White House restoration.
 - a) took down
 - b) took on
 - c) underestimated
 - d) underplayed
6. **MOUNTING** evidence indicates that acid rain is damaging historic sites in Cracow.
 - a) Increasing
 - b) Irrefutable
 - c) Hanging
 - d) Tentative
7. Most people know that Copernicus was an acclaimed astronomer, but how many realize that he also **WON** recognition for his talent as a politician?
 - a) achieved
 - b) anticipated
 - c) deserved
 - d) sought
8. Grunwald was the **SCENE** of one of the most famous victories of the Polish army.
 - a) adventure
 - b) event
 - c) landscape
 - d) location
9. The attack on Fort Sumter near Charleston **PROVOKED** a sharp response from the North, which led to the American Civil War.
 - a) defied
 - b) demanded
 - c) elicited
 - d) expedited
10. Bread has been a **STAPLE** of the human diet since prehistoric times.
 - a) basic part
 - b) fastener
 - c) great delicacy
 - d) highlight

11. As early as the eleventh century large groups of people DWELT IN the vicinity of our lake.
- longed for
 - planned for
 - resided in
 - worshipped in
12. The president requested from the parliament an APPROPRIATION to build a spacecraft.
- funding
 - guidance
 - power
 - property

* 222. HISTORY. Divide the vocabulary listed below into the following five groups:

- ROYAL FAMILY
- ROYAL HOUSEHOLD
- PEERAGE
- KNIGHT (EQUIPMENT)
- CASTLE

armour	banqueting-hall	baron	battlement	bedchamber
consort	courtyard	drawbridge	duke	dungeon
earl	fortress	gauntlet	herald	jester
king	lady-in-waiting	lance	marquis	minstrel
moat	page	prince	princess	queen
shield	sword	tower	turret	

223. ARMOUR. Match the elements of the knight's equipment listed above with the right numbers in the drawing below.

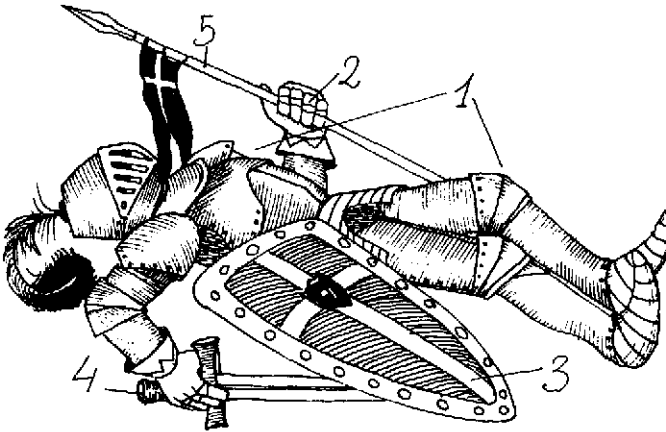

* 224. HISTORY. Choose the correct answer.

1. With an eighty-hour week and little chance or time for enjoyment, life must have been very for the nineteenth-century factory worker.
a) anxious b) dark c) hard d) pessimistic
2. A scholarship has been endowed to the memory of Sister Mary's work among the blind.
a) encourage b) foster c) perpetuate d) prolong
3. These tribes still the years of colonial domination bitterly.
a) disregard b) grudge c) object d) resent
4. Those columns have no practical purpose. They are purely
a) conspicuous b) decorative c) gaudy d) outstanding
5. This castle has not been lived in for years and the rooms smell very
a) dirty b) greasy c) grimy d) musty
6. Through the centuries of burning heat, the old castle walls had gradually and little was left of them now.
a) crumbled b) crumpled c) powdered d) shattered
7. There could have been a war over the disputed area but in the end reason
a) counted b) induced c) prevailed d) survived
8. The stone for building the cathedral was obtained from local
a) excavations b) mines c) pits d) quarries
9. Medieval travellers' tales of fantastic creatures were often fascinating but not always
a) conceivable b) credible c) credulous d) imaginable
10. The of the town-name is unknown, but it is certainly not from any Latin-based language.
a) descent b) derivation c) extract d) genesis
11. The castle was surrounded by a , which nowadays contains only occasional rainwater.
a) dyke b) fence c) hedge d) moat
12. The Duke had to sell the castle because he could no longer afford its
a) outlay b) subscription c) sustenance d) upkeep

XI. Houses and Homes

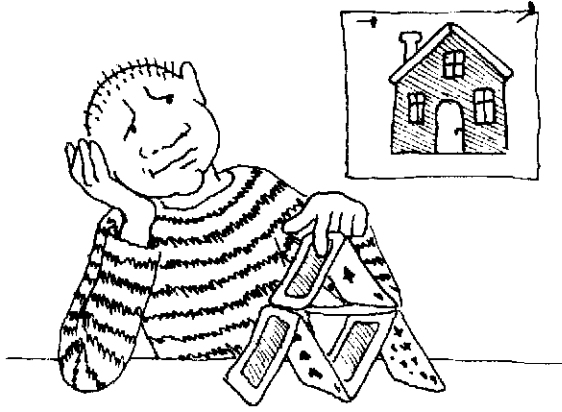

“We are living in a better neighbourhood now.”

“So are we.”

“Have you moved, too?”

“No. We’re still living in the same block you moved away from.”

*

“I knew an artist once who painted a cobweb on the ceiling so realistically that the maid spent hours trying to get it down.”

“Sorry, dear, I just don’t believe it.”

“Why not? Artists have been known to do such things.”

“Yes, but not maids!”

225. PLACES TO LIVE. Write the number of each drawing next to the correct word.

- bungalow
- block of flats
- caravan
- castle
- cottage
- detached house
- houseboat
- lighthouse
- mansion
- palace
- semi-detached house
- tent
- terraced house
- windmill

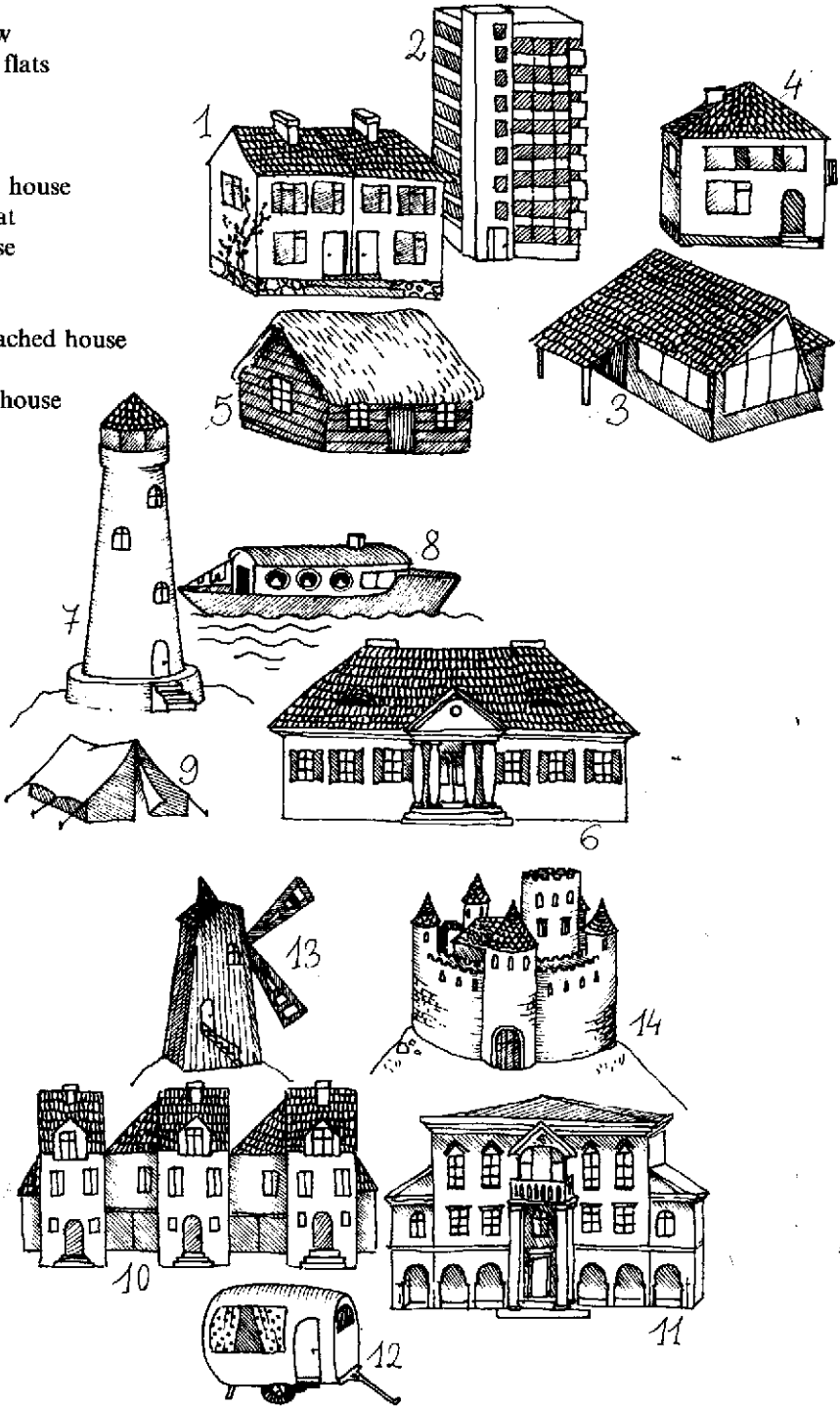

226. PLACES TO LIVE. *Choose the correct answer.*

1. They live in a(n) house which stands by itself in a field.
a) attached b) detached c) detaching d) semi-detached
2. Having made his fortune he now in great luxury in a large house in the country.
a) dwells b) inhabits c) leaves d) lives
3. My brother lives on the eleventh floor of that of flats.
a) block b) building c) house d) tower
4. His house is nothing out of the , it's just an average four-roomed house.
a) normal b) ordinary c) typical d) usual
5. Going down the street, she walked past a long of houses, all exactly alike.
a) queue b) rank c) row d) train
6. In the village he was looked up to as the lord of the
a) castle b) fortress c) manor d) tower
7. He keeps all his tools and do-it-yourself equipment in a in the garden.
a) barn b) hut c) shed d) stable
8. Our house isn't joined to the other houses in the street: it's
a) attached b) disconnected c) detached d) divided
9. The new police station is to be built the main square.
a) close b) near c) neighbourhood d) side
10. I am staying in a youth in the centre of the town.
a) hostel b) inn c) pub d) stable

227. PLACES TO LIVE. *What sort of people would you expect to find living in the following?*

- | | | |
|-------------|---------------|--------------|
| 1. barracks | 5. an inn | 9. a shanty |
| 2. a hotel | 6. lodgings | 10. a tent |
| 3. a hovel | 7. a mansion | 11. a wigwam |
| 4. an igloo | 8. a tenement | |

228. PLACES TO LIVE. *Complete each of the following sentences with an appropriate word for a type of building.*

1. He is a real prince and his family has lived in this _____ t _____ since the 14th century.
2. The high _____ y _____ in New York are mostly to be found in the central part of Manhattan.
3. Students can save money and make friends by living in a university _____ t _____ .
4. An elderly person is better off in a _____ a _____ with no stairs to climb.
5. I've always dreamed of moving to the country and living in an old _____ t _____ .
6. The student's room was so untidy it was like a p _____ .

7. When he was set free after twenty years in _____ s _____, he was amazed at the changes he found.
8. They don't live in a house, they live in a modern _____ c _____ of _____.
9. A family house standing on its own is called a _____ c _____ house.
10. He keeps his tools and equipment in a _____ he has put up in his garden.

229. PLACES TO LIVE. *Fill in the right word.*

1. This small cottage is _____ u _____ example of the local architecture of the 16th century. All the other buildings in the neighbourhood date from at least one hundred years later.
2. Originally this building was d _____ n _____ as a hotel. It was only after its construction began that they decided to turn it into a college.
3. The street was so narrow that she could not park her car. She had to park it on the _____ m _____ in front of the building.
4. They live outside the town centre in a little house in the _____ u _____.
5. We love our old house so much that we never want to _____ to a new one.
6. Many new apartments have been built in our neighbourhood. Our little old house is now s _____ n _____ by monstrous sky-scrapers.

230. KINDS OF HOUSING. *Put each of the following words or phrases into its correct place in the passage below.*

above	apartments	between	buildings
cities	communities	duplex	expensive
families	floors	homes	land
large	less	quarter	row
side	single	single-family	stores
suburban	wall		

Kinds of Housing

About two-thirds of the _____ in the United States live in single-family _____. About a _____ of the families live in _____ that have two to four _____, or in _____ or other commercial buildings that include apartments.

_____ cities have more apartment housing than small _____, because _____ is scarce and _____. Small towns and _____ areas, where land is _____ expensive than in city centres, have mostly _____ homes.

Philadelphia and other _____ have many _____ houses. These are usually single-family houses, one or two _____ high, standing _____ to wall. A _____ is a building with two apartments, either _____ by side with a _____ wall _____ them, or one _____ the other.

231. KINDS OF HOUSING. *Where do these people live or where might they be living at the moment?*

- | | |
|---|---------------------|
| 1. campers | _____ t |
| 2. holiday-makers who find hotels too expensive | g _____ h _____ |
| 3. a king | _____ c _____ |
| 4. monks | _____ n _____ |
| 5. nuns | _____ n _____ |
| 6. cowboys | r _____ -h _____ |
| 7. foresters in deep woods | (l _____ -) c _____ |
| 8. old people without families | o _____ 's h _____ |
| 9. skiers in the mountains | ch _____ |

232. HOUSES: BUILDING, REPAIRING OR BUYING. *Choose the right answer.*

- They bought the land with a to building a new office block.
a) goal b) purpose c) reason d) view
- Nowadays builders must get from the planning authorities before putting up a new house.
a) allowance b) freedom c) liberty d) permission
- Before you take the job on, would you give me a rough of how much it will cost?
a) estimate b) esteem c) value d) worth
- An architect planning a new house should always in mind his client's needs.
a) bear b) carry c) take d) train
- He gave some very advice on buying a house.
a) dear b) precious c) valuable d) wealthy
- The fire officer is coming to the building tomorrow.
a) inspect b) look c) watch d) witness
- They decided to down their original plans for the house and make it smaller.
a) change b) climb c) play d) scale
- In response to our advertisement, two couples are coming to over the flat tomorrow morning.
a) get b) look c) run d) pass
- Though badly damaged by fire, the palace was eventually to its original splendour.
a) renewed b) renovated c) repaired d) restored
- The house is part of his from his aunt.
a) heritage b) inheritance c) testament d) will

233. STAGES IN BUILDING A HOUSE. Put these stages in the right order and then match them with the expressions on the left.

- | | |
|-------------------|---|
| 1. First, | a. the drains are dug. |
| 2. Then, | b. the materials are bought. |
| 3. Meanwhile, | c. the house is painted. |
| 4. Subsequently, | d. the walls are built. |
| 5. At this stage, | e. the site is purchased. |
| 6. Next, | f. the site is levelled. |
| 7. Afterwards, | g. the foundations are laid. |
| 8. Then, | h. the house is ready to live in. |
| 9. Later, | i. the roof is put on. |
| 10. Eventually, | j. the doors and windows are put in. |
| 11. Finally, | k. the electricity and water systems are installed. |

234. HOUSES: BUILDING, REPAIRING OR BUYING. Choose the right answer.

- We are going to our house by building another room on to it.
a) develop b) extend c) spread d) stretch
- The charged by the architect for the plans of the new building were unusually high.
a) fees b) hire c) price d) sum
- The agents didn't letting all the new flats before the block was completed.
a) bargain b) expect c) foresee d) suspect
- The outside the house said: "PRIVATE".
a) advice b) label c) notice d) threat
- The of the house were dug in June and the roof was on by December.
a) basements b) ground floors c) scaffolds d) foundations
- When you build a house you must start by laying the
a) attic b) basement c) cellar d) foundations
- The house is old and it's in bad
a) condition b) damage c) situation d) state
- She was keen to the house to its original condition.
a) rebuild b) renew c) renovate d) restore
- We could have provided him with a detached house but he asked for a small flat.
a) decidedly b) solely c) specifically d) strongly
- The best person to approach if you are house-hunting is an estate
a) agent b) clerk c) official d) representative

* 235. **BUYING A HOUSE.** Put each of the following words or phrases into its correct place in the passage below.

buyer	contract	deposit
document	fixtures	information
lawyer	legal	possession
price	proof of ownership	property
purchaser	seller	signs
terms	time	

Buying a House

When a has chosen the house he wants, he has a draw up a contract. This states the definition of the, gives the purchase, and demands from the present owner. It also includes other important, such as the that are to remain in the house and the when the will take

The buyer pays a when he the, . The deposit binds the to the of the contract.

* 236. **BUYING A HOUSE.** Choose the right answer.

1. He refused to sell his house at the low offered.
a) expense b) figure c) money d) sale
2. There has been a in the sales of new houses since mortgages became more difficult to obtain.
a) broke b) crash c) dive d) drop
3. All their money is up in the new house they have bought.
a) connected b) limited c) lying d) tied
4. The of two houses proved such a financial burden that they were forced to sell one.
a) upkeep b) uproar c) upshot d) upsurge
5. I am not prepared to sell you my house unless you offer a more price.
a) actual b) correct c) realistic d) true
6. When my grandfather died, his house was put up for
a) auction b) bargain c) offer d) market
7. He bought his house on an plan, paying a certain amount of money each month.
a) instalment b) part c) piece d) share
8. Before you agree to buy that house, find out if the Building Society will give you a
a) credit b) deposit c) loan d) mortgage
9. His solicitor advised him to make sure that the house was fully by insurance.
a) covered b) defended c) guarded d) protected
10. The corrupt real-estate agent wanted to obtain the contract so he offered a to the civil servant.
a) bait b) bonus c) bribe d) tip

**** 237. BUYING A HOUSE.** Rewrite the following advertisement in its full form.

Mod. det. hse., immac. cond. Fhld. 3 gars. 5. beds., 3 receps., 2 fully tiled baths. + sep. wcs; lge. fit. kit. 18 × 9 ft., dble sink; lux. lnge. Gas CH/chw; dble. glaz. Curts., fit. cpts. included. Landscd. gdn., swim. pool. Few mins., stn., bus, amens., seafront. \$ 150,000 ono.

238. BUYING A HOUSE/FLAT. Choose the correct answer.

1. They sold their house for only \$ 15,000, so the buyer got a wonderful
a) amount b) bargain c) cost d) worth
2. If we want to buy a house, we'll have to our spending.
a) care for b) cut back c) let down d) save
3. The rise in house prices him to sell his house for a large profit.
a) achieved b) enabled c) managed d) succeeded
4. They me a good price for my house, so I sold it.
a) brought b) offered c) showed d) suggested
5. All house-owners need policy against thefts or accidents.
a) an assurance c) an insurance c) a protection d) a security
6. I advise you to take to ensure that your property is adequately covered by insurance.
a) actions b) dealings c) means d) steps
7. They great difficulty saving up enough money for a house.
a) achieved b) found c) had d) made
8. He bought that house, that he would inherit money under his uncle's will.
a) accounting b) assuming c) considering d) estimating
9. They made of over \$ 1,500 on the sale of their house.
a) a benefit b) a gain c) a fall d) a profit
10. He was lucky to get the house for less than the asking
a) amount b) cost c) price d) value
11. This house has been up sale for over a year now.
a) at b) for c) in d) to

239. RENTING A FLAT. Choose the correct answer.

1. The only of the flat is that it's a bit too small.
a) complaint b) disadvantage c) mistake d) sorry
2. They are going to ask the landlord to their rent.
a) drop b) leave c) lessen d) lower
3. The flat we have rented is very for the train station.
a) comfortable b) convenient c) near d) suitable

4. I would love to have a house , but for the time being I must rent this flat.
a) by my own b) for my own c) of my own d) to my own
5. Our main concern is to raise the lodgers' of living.
a) capacity b) conditions c) degree d) standard
6. Students in hostels are to keep their rooms clean and tidy.
a) desired b) expected c) hoped d) wanted
7. Are you going to your flat in Cracow while you are abroad?
a) dispose b) hire c) let d) sale
8. He asked if we would to share the room.
a) accept b) agree c) approve d) consider
9. The for the flat is \$ 70 a week.
a) due b) fee c) hire d) rent
10. We are into our new flat next week.
a) arriving b) entering c) moving d) transporting
11. The tenants were not to disturb other tenants after 11 p.m.
a) appealed b) demanded c) desired d) requested
12. Could we both stay at your flat? Have you got enough ?
a) area b) place c) room d) space
13. My landlady doesn't me to have parties.
a) agree b) allow c) appreciate d) approve
14. When the owner let the flat to me I signed a(n) that I would leave at the end of June.
a) advice b) agreement c) bargain d) insurance
15. a flat with someone is cheaper than living on your own.
a) Dividing b) Halving c) Parting d) Sharing
16. Your new flat me very much of the one we had in London.
a) recalls b) recollects c) remembers d) reminds
17. The of newcomers to longstanding residents is very high in this block of flats.
a) average b) cross-section c) percentage d) proportion
18. I should like to rent a flat; modern, comfortable and in a quiet position.
a) above all b) after all c) before all d) over all
19. The room was noisy and not very for studying.
a) fitted b) matching c) proper d) suitable
20. Many accidents in the home could be if householders gave more thought to safety in their houses.
a) avoided b) excluded c) preserved d) protected

**** 240. RENTING A FLAT.** Rewrite the advertisement in its full form.

A lux. s/c sgl. furn. gdn. flt. 1 rm., k. & b. C.H.

Cpts., Col. T.V., tel., fridge, ckr., h/c.

\$ 180 p.m. Refs. reqd.

Avail. mid. Apr.

Tel: 01-678-1234 Evgs after 7.

241. RENTING A FLAT. Choose the correct answer.

1. Some of the people living on the Council's new estate decided to set up a(n) association.
a) dwellers' b) football c) inhabitants' d) tenants'
2. There are several landlords approved by the university who take in
a) inhabitants b) lodgers c) residents d) settlers
3. The landlord requires a \$50 from tenants to cover possible damage.
a) bail b) deposit c) security d) tip
4. My landlady has recently signed an agreement renewing my for the next four years.
a) occupation b) possession c) residence d) tenancy
5. They the advantages and disadvantages of moving and finally decided against it.
a) asked themselves b) weighed up c) meditated d) thought
6. Having decided to rent a flat, we contacting all the accommodation agencies in our city.
a) set about b) set off c) set out d) set to
7. The Housing Committee has decided to give to young married couples with children.
a) preferment b) presentation c) prestige d) priority
8. Homeless families the empty houses and started to renovate and redecorate them.
a) homed b) moved c) squatted d) tenanted
9. When the landlord died all the sitting tenants were given notice to
a) depart b) disappear c) leave d) quit
10. The landlord them because they hadn't paid their rent for three months.
a) demolished b) dismissed c) evicted d) threw out

*** 242. RENTING A FLAT.** Choose the right answer.

1. The scarcity of housing accommodation means that people can no longer afford to where they live.
a) buy and sell b) come and go c) look and see d) pick and choose
2. Considering how few services we get, the rates we pay are
a) daylight robbery b) down to earth c) out of this world d) peanuts

3. The squatters are fighting and nail not to be evicted from the houses they have occupied.
 a) finger b) hammer c) toe d) tooth
4. He lives a(n) throw from the station.
 a) apple's b) arrow's c) knife's d) stone's
5. You've managed to find a cheap flat near Picadilly Circus. you!
 a) Happy b) Fortunate c) Lucky d) Merry

243. PARTS OF A HOUSE. *Write where you would expect to find the following rooms in a house and what they would normally be used for.*

- | | |
|------------------|------------------------|
| 1. attic | 5. lavatory/toilet/loo |
| 2. basement | 6. loft |
| 3. cellar | 7. lounge |
| 4. larder/pantry | 8. study |

*** 244. PARTS OF A HOUSE.** *Match the definition with the correct part of a house.*

- | | |
|--------------------|--|
| 1. alcove | a. windows made up of two panes of glass instead of one |
| 2. attic | b. the half-pipe along the edge of the roof to carry away rainwater |
| 3. chimney | c. a small space in the form of a small room added to another room for a bed, books, etc. |
| 4. cellar | d. a window in the roof |
| 5. central heating | e. used in modern houses instead of open fires |
| 6. double glazing | f. the space at the top of the stairs |
| 7. French windows | g. a roofed entrance built onto a house |
| 8. hall | h. doors made of glass which usually open out onto the garden |
| 9. guttering | i. a hall or corridor, not a room, which leads from the entrance to the rooms inside a building |
| 10. landing | j. the wide passage just inside the entrance of a house off which the rooms open |
| 11. lobby | k. a room immediately below the roof of a house |
| 12. lounge | l. a hollow passage often rising above the roof of a building which allows smoke and gases to pass from the fire |
| 13. niche | m. an underground room, usually used for storing goods |
| 14. porch | n. a comfortable room for sitting in |
| 15. skylight | o. a hollow place in a wall, usually made to hold an ornament, books, etc. |

* 245. PARTS OF A HOUSE. Indicate the following parts of a house on the drawing below.

alcove	attic	chimney	cellar
French windows	guttering	skylight	porch

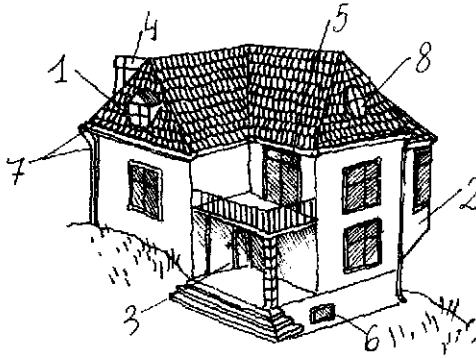

246. PARTS OF A HOUSE. Choose the correct answer.

1. A row of trees the house from the north wind.
a) fence b) prevent c) shelter d) warn
2. The house is old and it's in bad
a) condition b) damage c) situation d) state
3. Many old houses have an underground room called a(n)
a) attic b) cave c) cellar d) loft
4. People were strolling under the trees on either side of the broad through the park.
a) alley b) avenue c) path d) track
5. His flat is in the
a) basement b) cellar c) ground d) lift
6. He hung up his overcoat in the as soon as he came into the house.
a) attic b) cellar c) hall d) loft
7. The shop had on the door but it was closed.
a) available b) free c) open d) vacant
8. Some town children had never seen grass or trees and could play only in a small between their houses.
a) field b) garden c) park d) yard
9. There was a magnificent drive which round to the front of the mansion.
a) arched b) bent c) curved d) inclined
10. Three stone lead up to the front door.
a) levels b) stairs c) stones d) steps
11. It is a large building, on six , and many families live there.
a) flats b) floors c) stages d) stairs
12. The from the gate to the cottage was overgrown with weeds.
a) passage b) path c) road d) street

13. The hall seemed lit after the bright sunshine outside.
 a) dimly b) faintly c) slightly d) vaguely
14. Their office of four small rooms.
 a) consists b) contains c) includes d) numbers
15. He went down to his workshop in the
 a) annexe b) basement c) ground floor d) loft
16. In this part of the country, the fields are separated by stone
 a) barriers b) fences c) hedges d) walls
17. My address is 52 Long Street, and I live on the
 a) basement b) cellar c) ground floor d) foundations
18. Their flat is on the top
 a) attic b) floor c) loft d) store
19. They have a tennis at the bottom of their garden.
 a) court b) field c) ground d) pool
20. We haven't got a garage, so we leave our car outside in the
 a) drive b) garden c) pavement d) porch

247. PARTS OF A HOUSE. Write in which room you would look for the following people.

- | | | | |
|--|---|---------|--------------|
| 1. an artist | a | __ t | _____ |
| 2. a corpse | a | m | _____ |
| 3. a football player after the match | a | ch | _____ - room |
| 4. a gardener in winter | a | g | _____ |
| 5. a novelist | a | s | _____ |
| 6. a patient before an appointment | a | _____ | room |
| 7. a photographer developing pictures | a | _____ k | _____ |
| 8. a pilot while flying | a | c | _____ t |
| 9. a prisoner | a | _____ l | _____ |
| 10. some off-duty soldiers | a | m | _____ |
| 11. some workers during their lunchbreak | a | c | _____ |
| 12. some teachers between lessons | a | s | _____ |

*** 248. PARTS OF A HOUSE.** Choose the right answer.

1. The smell of the dirty alley drove us away.
 a) foul b) grimy c) polluted d) squalid
2. He waited in the for the front door to open.
 a) crypt b) inlet c) porch d) threshold
3. Although most of the rooms are small, the hall is
 a) abundant b) extended c) spacious d) tiny

4. The of the roof kept the rain off better.
a) climb b) flow c) plane d) slope
5. The villa has excellent for cooking and for washing clothes.
a) amenities b) conveniences c) facilities d) utilities
6. In the old house he had to bend down to avoid hitting his head on the
a) beams b) bearings c) props d) supports
7. The kitchen was small and so that the disabled woman could reach everything without difficulty.
a) compact b) complete c) complex d) contained
8. The only way to see into the basement room was by peering through the at the bottom of the wall.
a) drain b) fanlight c) grating d) skylight
9. The built onto the back of the house provided valuable extra space.
a) development b) enlargement c) extension d) growth
10. In the room resembles the letter L.
a) figure b) form c) pattern d) shape

249. HOUSES. *Fill in the right words.*

1. My landlord has decided to increase my _____ next year.
2. Leave your umbrella in the stand in the _____.
3. The main _____ n _____ was locked so they had to use the _____ door.
4. Our flat is in very poor shape now. Last time we had it _____ c _____ was ten years ago.
5. It was very cold in the _____ r _____ so she covered her sleeping daughter with an extra blanket.
6. If you want the estate agent to sell the house for you, you'll have to let him see the d _____ s that show you're the legal owner.
7. It was very stuffy in the room and the air was difficult to _____ t _____.
8. I expected my husband to come home late, therefore I left the door _____ k _____.
9. "Would you like to take a _____?" "No, thanks, I've just had a shower."
10. _____ on the door before you come into the room!
11. Your room is a terrible _____! Clean it up at once!
12. In Britain a home loan is usually referred to as a m _____.
13. Our children no longer sleep in the same room. They have _____ r _____ bedrooms now.
14. We were all at home last night sitting watching television in the _____ u _____.
15. I put an _____ d _____ for a flat in the newsagent's window, but I haven't had any replies yet.

250. HOUSES. *Choose the right answer.*

1. The street lamps are switched on automatically at
a) dark b) dusk c) evening d) sunrise
2. His bedroom the park.
a) overlooks b) oversees c) overtakes d) undergoes
3. The bright colour of the woodwork rather from the quiet beauty of the house.
a) contracts b) detracts c) distracts d) extracts
4. The old houses were down to make way for a block of flats.
a) banged b) hit c) knocked d) put
5. My house is very for getting to work as it is only a few minutes from the station.
a) convenient b) fit c) suitable d) useful
6. There were so many new buildings in the town that she hardly the place.
a) distinguished b) identified c) made out d) recognised
7. It is only a small flat but it my needs perfectly.
a) fills b) fits c) settles d) supplies
8. We are into our new house on Monday.
a) arriving b) entering c) moving d) transporting
9. This house has only been since last summer.
a) dwelled b) lived c) occupied d) resided
10. Just looking at the room you would have no idea of the real purpose it
a) filled b) served c) took d) used
11. They've finally decided to that lovely old house on the hill.
a) appoint b) preserve c) renew d) renovate
12. In recent years there has been a(n) increase in the cost of living.
a) important b) powerful c) significant d) wide
13. The Newrichs have just bought a beautiful house in the country.
a) aged b) ancient c) antique d) old

251. HOUSES. *Give a synonymous word for the capitalized expression.*

1. For a moment we sat **WITHOUT ANY LIGHT AT ALL**.
For a moment we sat in complete
2. **HOW LONG** is the new pitch?
What is the of the new pitch?
3. It took us about an hour to **GET ALL THE GOODS OFF** the lorry.
It took us about an hour to the lorry.
4. He pays **A LOT OF MONEY FOR HIS FLAT**.
He pays a high for his flat.
5. We live in a **RESIDENTIAL DISTRICT AWAY FROM THE CENTRE OF TOWN**.
We live in a

*** 252. HOUSES.** *Choose the right answer.*

1. Greg is in the garden, chopping for the fireplace.
a) forests b) trunks c) twigs d) wood
2. It was very in the cottage with the comfortable armchairs by the fire.
a) easy b) gratifying c) refreshing d) snug
3. In spite of the thunderstorm, the children slept all night.
a) noisily b) roundly c) resonantly d) soundly
4. Do open the window; this room seems very
a) breathless b) mouldy c) rancid d) stuffy
5. Believing herself alone in the house she was when she heard someone moving about in the hall.
a) amazed b) annoyed c) incredulous d) startled
6. He took out a big of keys, and opened the door.
a) branch b) bunch c) group d) packet
7. The children round the fire to keep warm.
a) cloistered b) grouped c) huddled d) tucked
8. The of the family home following the divorce was a great shock to the children.
a) break-down b) break-in c) break-out d) break-up
9. The house looked in the failing evening light.
a) austere b) lucky c) severe d) strict
10. I have lived near the railway for so long now that I've grown to the noise of the trains.
a) accustomed b) aware c) familiar d) unconscious

253. FURNITURE AND FITTINGS. *Choose the right answer.*

1. Some rooms don't have curtains at the windows, they have
a) blinds b) carpets c) gates d) stores
2. When Madeleine lost her front-door , she went straight to the police-station.
a) bolt b) fastener c) key d) lock
3. I was so tired last night that I fell asleep the moment my head touched the
a) bed b) blanket c) cushion d) pillow
4. It was on the top shelf, out of
a) achievement b) attempt c) reach d) touch
5. It was very dark in the cellar so he a match.
a) rubbed b) scraped c) scratched d) struck
6. What a beautiful ! It's a pity we don't have any flowers to put in it.
a) crystal b) cup c) glass d) vase
7. The house is quiet because the carpets are so
a) fat b) heavy c) smooth d) thick

8. It was difficult to see anything because the lights were so
a) dim b) dull c) faded d) weak
9. The table was a curious as both the top and the legs were curved.
a) form b) model c) pattern d) shape
10. Have you got a in your bag? It's so dark here that I can't even see the path.
a) bulb b) candle c) lantern d) torch
11. She closed the windows and drew the before switching on the light.
a) coverings b) curtains c) masks d) shades
12. One end of his single room was used as a kitchen but this was hidden behind a
a) blind b) screen c) shield d) veil
13. When she cleaned the high windows, she always stood on a three-legged
a) bench b) chest c) ladder d) stool
14. They us how to work the machine.
a) begged b) demonstrated c) explained d) showed
15. Please wipe your feet on the door- before you come in.
a) blanket b) mat c) rug d) tile
16. You shouldn't leave your bicycle outside in the rain. It will get.
a) broken b) muddy c) oxidised d) rusty
17. The old lady managed to climb the which was narrow but not all that steep.
a) degree b) ladder c) scale d) staircase
18. The vacuum cleaner is a valuable labour-saving for the busy housewife.
a) device b) engine c) instrument d) piece

254. FURNITURE AND FITTINGS. THE LIVING ROOM. Give the names of the indicated items of furniture.

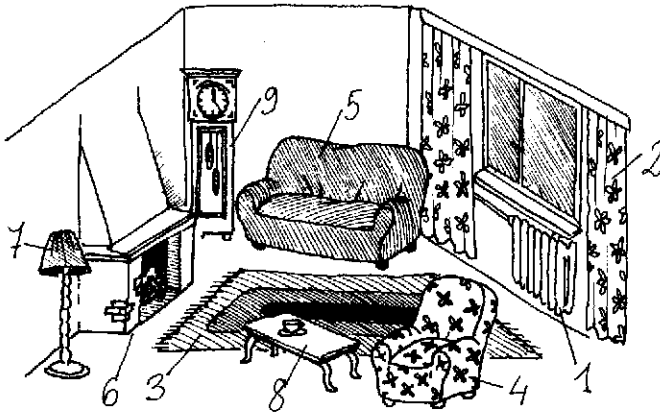

- | | | |
|------------------|--------------------|------------------|
| 1. r _____ | 2. _____ t _____ s | 3. _____ p _____ |
| 4. _____ c _____ | 5. s _____ | 6. _____ l _____ |
| 7. _____ s _____ | 8. c _____ t _____ | 9. _____ |

255. FURNITURE AND FITTINGS. *Choose the right answer.*

1. She couldn't see herself in the mirror because of the rising from the hot bath.
a) fog b) mist c) smoke d) steam
2. Her room is comfortable but rather on the small
a) angle b) basis c) side d) size
3. This chair looks very to our old grey one.
a) exact b) familiar c) like d) similar
4. There were four chairs in the living room, one in each
a) corner b) edge c) side d) wall
5. This beautiful wardrobe has been in our family for over two centuries and is now very
a) dear b) expensive c) precious d) valuable
6. This table would nicely for Mary's room.
a) agree b) do c) fit d) suit
7. She wanted to remove the colour from the curtains so she them.
a) bleached b) dried c) dyed d) rinsed
8. It was a strange clock with an hour that was longer than the minute one.
a) finger b) hand c) needle d) rod
9. Whether or not you like some kinds of modern furniture is a matter of
a) comparison b) favour c) taste d) vogue
10. Be careful how you handle this vase as it is
a) invaluable b) priceless c) valueless d) worthy
11. The windows don't fit very well and it makes the room awfully
a) airy b) breezy c) draughty d) ventilated
12. Where do you your pencils? In this drawer?
a) close b) guard c) hold d) keep

*** 256. FURNITURE AND FITTINGS.** *Choose the right answer.*

1. Be careful going up the stairs, Ma. Hold on to the
a) banister b) edge c) railing d) side
2. If you have a new key cut, it must be an exact of the existing one.
a) counterfeit b) copy c) imitation d) model
3. The kitchen of the holiday cottage looked rather than beautiful.
a) mundane b) practicable c) utilitarian d) workable
4. They had four children so the new washing-machine was a great
a) advantage b) aid c) benefit d) boon
5. Mrs Elegant has had the couch in her sitting-room in red velvet.
a) clothed b) enriched c) sewn d) re-upholstered

6. The room was so with furniture that is was impossible to move.
a) assembled b) burdened c) cluttered d) overrun
7. Switch on the lamp, it casts a nice warm on the polished furniture.
a) beam b) glow c) sheen d) shine
8. The wind blew so hard and so strongly that the windows in their frames.
a) flapped b) rattled c) shocked d) slapped
9. Do you know that Mrs Impudent has bought curtain material exactly the same as ours.
She's a dreadful
a) ape b) copy-cat c) mocking bird d) parrot
10. You'd better pack those glasses extremely carefully if you want them to arrive
a) complete b) entire c) intact d) whole
11. It is advisable to pull down the when the sun is very hot.
a) blinds b) covers c) screens d) shutters
12. The drawer is You will have to get something to break it open.
a) fixed b) jammed c) loose d) rooted

257. FURNITURE AND FITTINGS. THE BEDROOM. Match each of the following names of items of furniture and fittings with the correct number in the picture.

- ... wardrobe
- ... pillow
- ... pillow-case
- ... sheet
- ... bedspread
- ... mattress
- ... bedside table
- ... dressing-table
- ... stool
- ... mirror
- ... chest-of-drawers
- ... rug

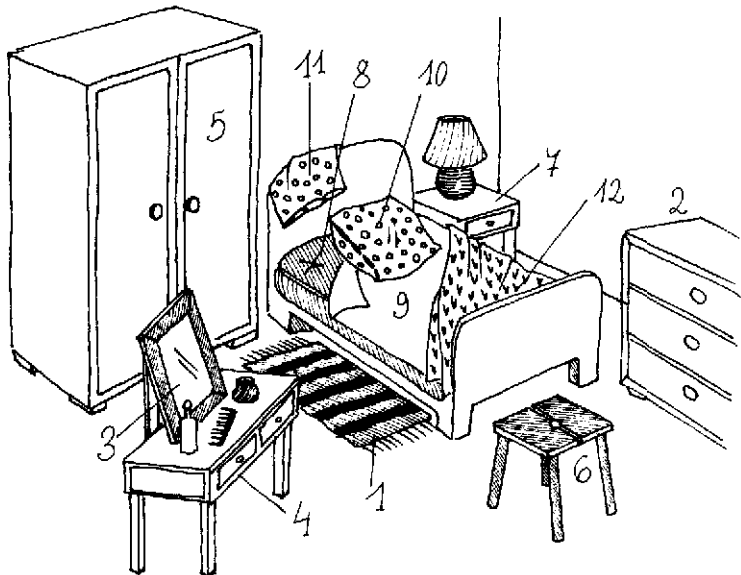

258. FURNITURE AND FITTINGS. *What would you expect to find in the following?*

- | | |
|-----------------------|----------------|
| 1. a bureau | 4. a safe |
| 2. a chest-of-drawers | 5. a sideboard |
| 3. a linen chest | 6. a wardrobe |

259. FURNITURE AND FITTINGS. THE BATHROOM. *Match each of the following names with the correct number in the picture.*

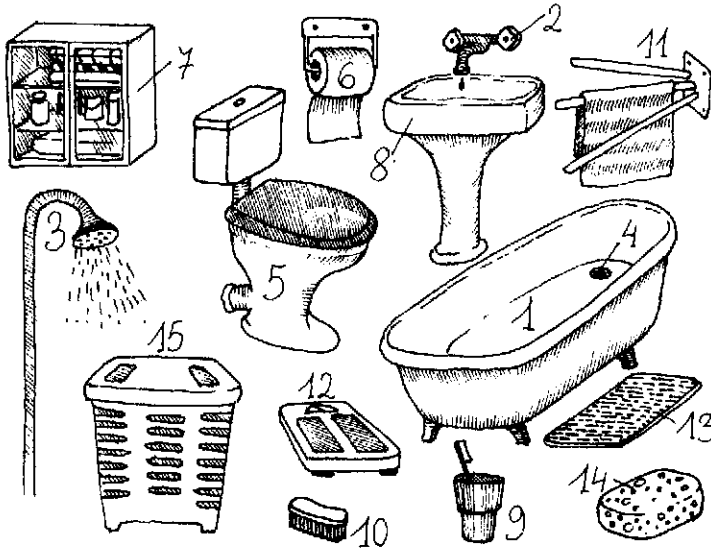

- | | | | |
|----------------------|--------------------|-----------------|----------------|
| ... bath | ... laundry-basket | ... shower | ... tooth-mug |
| ... bathmat | ... lavatory | ... sponge | ... towel rail |
| ... bathroom cabinet | ... nailbrush | ... tap | ... wash-basin |
| ... bathroom scales | ... plug-hole | ... toilet-roll | |

260. FURNITURE AND FITTINGS. *Arrange the following household contents under three headings:*

1. Furniture
2. Household appliances
3. Soft furnishings

- | | | | | |
|-------------|----------|--------------|-------------|----------------|
| bedding | chairs | dishwasher | sideboard | television |
| beds | cooker | freezer | tables | vacuum cleaner |
| bookshelves | curtains | refrigerator | tablecloths | wardrobes |
| carpets | cushions | rugs | telephone | |

*** 261. FURNITURE AND FITTINGS.** *Choose the best answer.*

- All the rooms have carpets, which are included in the price of the house.
a) adapted b) equipped c) fitted d) suited
- She read him a good-night story, him up and then kissed him and turned the light off.
a) fixed b) folded c) packed d) tucked
- The Palace offered a variety of riches: Persian rugs, marble tables, etc.
a) affluent b) opulent c) unsaleable d) wealthy
- Put the vase on the over the fireplace.
a) ledge b) mantelpiece c) sill d) step
- The children were sleeping in bed.
a) easily b) homely c) snugly d) softly
- Don't leave your coat on the chair, hang it on the behind the door.
a) bracket b) hook c) lump d) rod
- In the old days, curtains were hung over doors to keep out
a) breezes b) currents c) draughts d) gales
- The drawer is ; I shall have to try and open it with a knife.
a) bolted b) dislocated c) screwed d) stuck
- With its expensive furniture and carefully-chosen colour scheme the room looked
a) convenient b) homely c) luxuriant d) luxurious
- The room was of furniture.
a) absent b) devoid c) scanty d) scarce
- As Mary opened the door, the candle in the breeze and then went out.
a) flamed b) flickered c) sparkled d) twinkled
- There is no danger in using this machinery as long as you to the safety regulations.
a) abode b) adhere c) comply d) observe

262. FURNITURE AND FITTINGS. *Complete the following sentences.*

- I keep all my clothes in the bedroom in a big _____ r _____ .
- The silver _____ t _____ on the table were shining brightly because they reflected the flickering light of the _____ n _____ .
- It was a cold evening so I had a log fire going in the _____ r _____ .
- The most important thing about a house or flat is that it should be h _____ .
- My grandfather likes to sit in his favourite _____ c _____ , smoking his _____ p _____ .
- I thought these were real flowers, but they are _____ f _____ . They are made of plastic.
- In Cracow, in order to get RAIUNO reception, it's essential to have a proper a _____ .
- The _____ g _____ of this carpet is about 8 ft.

9. Although we now have eight chairs, I'm afraid this will not be _____ g _____ and some of our guests will have to sit on that old _____ t _____.
10. I eventually found the scissors I'd lost behind the chest of _____ w _____.
11. Our house has central heating, so every room has a _____ d _____.
12. Doors that go round and round are called r _____ doors.
13. It is very difficult nowadays to find cheap and comfortable a _____ n in Cracow.
14. Everything in my kitchen is stored away in _____ b _____.
15. A door swings on its _____ n _____.

263. OPERATING HOUSEHOLD APPLIANCES. *Choose the correct answer.*

1. When you turn off the TV, please pull out the, too.
a) block b) plug c) switch d) wire
2. The electricity failure is not dangerous. There is no need for
a) alarm b) cowardice c) dread d) scare
3. When you this red button, the machine stops.
a) hit b) lift c) press d) pull
4. He the tap but could get no water.
a) adjusted b) controlled c) opened d) turned on
5. Where is the book of for using this washing machine?
a) directives b) instructions c) orders d) regulations
6. Can you help me? I can't how to start this machine.
a) do in b) get on c) set down d) work out
7. Don't touch that wire or you may get an electric
a) attack b) current c) shock d) surprise
8. Mr Impatient kicked the washing machine to try to it work.
a) cause b) force c) get d) make
9. The door will open if you it hard.
a) hold b) knock c) push d) throw
10. You can get drinking water by turning this
a) knob b) pipe c) switch d) tap
11. He wanted a bath but couldn't find the
a) cork b) lid c) plug d) stopper
12. I the door-bell several times but there was no-one at home.
a) knocked b) pulled c) rang d) squeezed
13. Ms Forgetful can't use her hair-drier as she forgot to buy a for it.
a) pin b) plug c) socket d) switch
14. A food processor has become an indispensable piece of in the home.
a) device b) equipment c) gadget d) machine
15. Who's left the tap running? There's a of water on the floor.
a) bucket b) heap c) pool d) stain

* 264. OUT OF ORDER. Choose the right answer.

1. The bath water doesn't run away properly; I think the must be blocked.
a) conductor b) hole c) pipe d) tube
2. The tap was dripping because it needed a new
a) rubber b) stopper c) washer d) wringer
3. There is a lot of water on the floor. I think the washing machine must be
a) dropping b) leaking c) oozing d) seeping
4. Phone the ! Water is pouring down the stairs.
a) builder b) engineer c) piper d) plumber
5. We'll have to use the stairs as the lift is out of
a) function b) movement c) order d) practice
6. My washing machine has, so I'm going to the laundrette.
a) broken down b) gone out c) run down d) worn out
7. There is something with my TV. The picture won't come on.
a) bad b) missing c) unusual d) wrong
8. I can smell gas — there must be a somewhere.
a) break b) drip c) flow d) leak
9. He has a little next to his garage where he makes things for the house.
a) housework b) mill c) workhouse d) workshop
10. The central heating doesn't seem to be properly.
a) going b) performing c) warming d) working
11. When I turned on the switch, the lights
a) cracked b) expired c) fired d) fused
12. I can't open this case; the seems to be jammed.
a) bolt b) catch c) closing d) lock
13. He swatted a fly on the window and the glass.
a) broke b) cracked c) cut d) slashed
14. We shall have to have the deck-chairs repaired. The canvas has
a) broken b) burst c) cracked d) split
15. My binoculars were not actually broken, they just needed
a) adjusting b) curing c) mending d) repairing
16. Most of the machines are as a result of an electric breakdown.
a) disused b) idle c) out of work d) powerless
17. I think there is something wrong with my lamp. I a shock when I tried to switch it on.
a) got b) made c) suffered d) took
18. The water could not flow freely because the pipe was
a) blocked b) bolted c) loaded d) trapped
19. She keeps a supply of candles in the house in case of a power
a) absence b) cut c) lack d) shortage
20. I should like to point out that two months have since you promised to come and repair my television.
a) elapsed b) expired c) lapsed d) transpired

265. CONNECTORS. Match each of the following connectors with the correct number in the picture below.

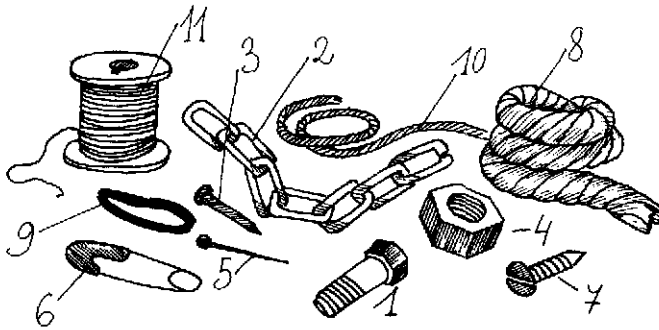

- | | |
|-----------------|----------------|
| ... thread | ... screw |
| ... chain | ... nut |
| ... string | ... safety pin |
| ... rope | ... pin |
| ... rubber band | ... bolt |
| ... nail | |

266. CONNECTORS. Crossword puzzle.

1	—	C	— — — —
2	—	O	— —
3	— —	N	— — — —
4	—	N	— — — —
5	— — — —	E	— — — —
6	—	C	— — — — — —
7	— —	T	— — — —
8	—	O	— — — —
9	—	R	— — — — — —
10	—	S	— — — — — —

1. we use a screwdriver to put it on or take it out (5)
2. mountaineers use it to keep together and avoid falling (4)
3. it is used in dressmaking to hold pieces of cloth together (3)
4. we use a hammer to knock it into wood (4)
5. we use a needle to sew cloth with it (6)
6. it is made of iron and it is used to keep large ships in place in port (5)
7. it is made of metal and is used with 8. to keep different parts of machines together (3)
8. used with 7. to keep different parts of machines together (4)
9. to pin a notice to a notice board we use pins (7)
10. we tie up a parcel with it (6)

267. TOOLS. Match each of the following tools with the correct picture below.

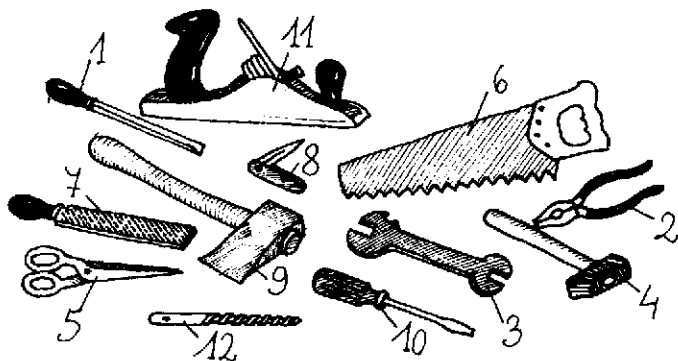

- | | | | |
|------------|-----------------|--------------|-------------|
| ... axe | ... chisel | ... drill | ... file |
| ... hammer | ... screwdriver | ... penknife | ... plane |
| ... pliers | ... saw | ... scissors | ... spanner |

268. TOOLS. Complete each of the following sentences with the name of a tool. Each dash (—) represents one letter.

- We cut down trees with an _____.
- We cut paper or cloth with a pair of _____.
- We knock nails into wood with a _____.
- We raise a car to change a wheel with a j_____.
- We put in and take out screws with a _____.
- We tighten or loosen nuts with a s_____.
- We saw wood with a _____.
- We bend and cut wire with p_____.
- We break up roads, rocks, etc. with a p_____.
- We draw corks out of bottles with a c_____.

269. TOOLS. Choose the right answer.

- I'll lend you my to chop down the tree.
a) axe b) jack c) saw d) spanner
- The screw on the cupboard seems to have worked
a) away b) loose c) unfixed d) unsteady
- I must cut this sheet of paper in two. Would you pass me the
a) axe b) chisel c) pickaxe d) scissors
- The axe left lying on a bench in the rain was now covered with
a) dirt b) dust c) mud d) rust
- Put some oil on that tight nut; that might the trick.
a) do b) make c) win d) work

6. These bolts are much too stiff to loosen by hand. Have you got a ?
a) jack b) key c) screwdriver d) spanner
7. What is the use of having a hammer, if you haven't any ?
a) bolts b) hooks c) nails d) screws
8. The simplest way to get this nut off the bolt would be to use a
a) chisel b) jack c) screwdriver d) spanner
9. A small is handy for minor electrical jobs in the home.
a) hammer b) nail c) screwdriver d) saw
10. He hammered a into the wall.
a) nut b) nail c) pin d) screw

270. HOUSEHOLD CHORES. *Choose the right answer.*

1. Granny is coming for lunch. Please the room before she arrives.
a) arrange b) order c) polish d) tidy
2. You shouldn't walk around with feet. The floor isn't very clean.
a) bare b) naked c) nude d) stripped
3. The attic was thick with as no one had cleared it for years.
a) dust b) powder c) rust d) sediment
4. Will you the beds at once! Our guests are at the door!
a) clean b) cover c) make d) smooth
5. The house felt cold and after weeks of bad weather.
a) damp b) moist c) watery d) wet
6. If you don't like washing up, you could into the possibility of buying a washing-up machine.
a) ask b) look c) order d) save
7. I must get to the laundry and my washing.
a) bring b) carry c) clean d) collect
8. Mrs Helpful has cleaned our house from to bottom.
a) attic b) first floor c) roof d) top
9. The only way to clean the box is to it in soap and warm water.
a) brush b) polish c) wash d) wipe
10. Don't forget to put the back on the toothpaste when you have finished with it.
a) cap b) cover c) hat d) lid
11. She has to work hard to keep the house and tidy with such a big family.
a) arranged b) neat c) ordered d) smooth
12. "..... your feet before you come into the house," cried Mrs Tidy.
a) Clean b) Polish c) Rub d) Wipe
13. Your for today is to do the washing up.
a) duty b) homework c) labour d) task

14. Ask your sister if she could give me with the washing up.
a) an aid b) an assistance c) a hand d) a help
15. They managed to get all their unwanted things at the jumble sale.
a) away with b) even with c) out of d) rid of
16. When you've washed up, the plates before you put them away.
a) clean b) dry c) dust d) sweep
17. It's your to clean the room; I did it last week.
a) occasion b) time c) try d) turn
18. the tube gently, so as not to waste the toothpaste.
a) Hit b) Lick c) Press d) Squeeze
19. Don't leave your coat lying on the sofa like that! Hang it up by the at the back of the collar.
a) band b) hole c) hook d) loop
20. Please close the window; there's a terrible
a) breeze b) current c) draught d) headwind

*** 271. HOUSEHOLD CHORES.** *Choose the correct answer.*

1. Her mother had asked her to do several before she went out.
a) jobs b) labours c) studies d) works
2. We had on the attic last weekend, and cleared out fifteen years' accumulation of odds and ends.
a) an attack b) a blitz c) an invasion d) a raid
3. There was a of rubbish in the corner of the bedroom.
a) dump b) mass c) pile d) stack
4. Mike picked up a and went out to clear the snow away from the front of the house.
a) fork b) jack c) rake d) shovel
5. Do straighten that picture over the fireplace, it looks from here.
a) bent b) crooked c) inclined d) uneven
6. It was cold enough for a fire so Mr Obedient went off to some wood.
a) chip b) chop c) crumble d) splinter
7. The drunken couple did nothing to keep the flat clean and tidy and lived in the utmost
a) contamination b) decay c) pollution d) squalor
8. I just have a few household to cope with and then I'll be able to rest.
a) assignments b) charges c) chores d) works
9. There must be something I can do to breaking your favourite tea-pot.
a) face up to b) go in for c) make up for d) put up with
10. He has a(n) habit of emptying ashtrays out of his window on to our doorstep.
a) disgusting b) offending c) uncultivated d) uneducated

*** 272. DECORATING. Choose the right answer.**

1. Before beginning to use the paint, you should it in the tin.
a) roll b) stir c) turn d) twist
2. Always wear goggles when spraying paint as a against damage to your eyes.
a) prevention b) refuge c) restriction d) safeguard
3. The house was built more than a hundred years ago. My father had it when he bought it.
a) altered b) changed c) renewed d) transformed
4. Changing the colour of the room seemed a good at the time, but they regretted it later.
a) belief b) idea c) opinion d) thought
5. This room looks terrible, it's in such a
a) disorder b) litter c) mess d) rubbish
6. I think the pattern on that wallpaper has been printed
a) back to back b) face down c) side to side d) upside down
7. The house is in good though it needs to be repainted.
a) condition b) position c) standing d) state
8. The colour of the handle does not so long as it is the right size.
a) affect b) concern c) matter d) worry
9. It's we did something about redecorating the sitting-room.
a) full-time b) good time c) high time d) long time
10. The floor was so rotten that it almost under his weight.
a) gave away b) gave back c) gave up d) gave way
11. The Bears have just had their sitting room
a) coloured b) dyed c) redecorated d) replaced
12. In my opinion, standards of workmanship have over the past ten years.
a) aggravated b) declined c) diminished d) eroded
13. Could you give me a rough of what the job might cost?
a) account b) correlation c) estimate d) value
14. My brother has just had central heating in his flat.
a) inlaid b) inset c) installed d) introduced
15. The storm a lot of houses in the village.
a) blew b) damaged c) disturbed d) drowned

*** 273. DECORATING. Choose the right answer.**

1. It took us only one day to the paper off all four walls.
a) chip b) paste c) scrape d) stroke
2. If you paint the walls cream, I think it will the colour of the curtains better.
a) bring out b) lift out c) make out d) take out

3. If the door has jammed, there's no point in trying to force it open. You'll only the handle off.
a) drag b) gouge c) pluck d) pull
4. If you want to change the colour of these walls, they will need at least two of paint.
a) coats b) coverings c) layers d) sheets
5. That door when you open it. You must put some oil on the hinges.
a) creaks b) rustles c) screeches d) shrieks
6. All the windows of the house were by the explosion.
a) crashed b) crushed c) shattered d) shredded
7. What a(n) colour that wallpaper is! Why ever did you buy it?
a) alarming b) bad c) dreadful d) frightening
8. That window needs a new of glass.
a) mirror b) oblong c) pane d) square
9. I think we should have glass put in the bathroom window. The people on the other side of the street can see right in.
a) cracked b) frosted c) patterned d) thick
10. The renovation work will closing the local library for at least two months.
a) accomplish b) ensure c) entail d) result
11. The firm deals more with decoration than building.
a) inside b) interior c) internal d) inward
12. Shall we off all this awful old wallpaper and paint the room instead?
a) rip b) scratch c) strip d) tear
13. The front door is in a terrible state; the paint is badly.
a) crumbling b) eroding c) flaking d) rotting
14. To my I noticed that the roof was leaning to one side.
a) consternation b) constitution c) constriction d) consumption

274. TOWNS AND VILLAGES. *Choose the right answer.*

1. I love to round the old part of the town, enjoying its peace and quiet.
a) rush b) sit c) tour d) wander
2. The town stands mainly on the left of the river.
a) bank b) cliff c) coast d) shelf
3. The farm area as far as the river.
a) advanced b) developed c) extended d) lay
4. The current of this town is about 350 000.
a) group b) membership c) number d) population
5. The hotel has been built on the of a lake.
a) border b) boundary c) edge d) front
6. Uncle Billy has bought a piece of near the sea and is going to build a house there.
a) country b) earth c) land d) territory

7. Our old house in a beautiful spot deep in the woods.
a) placed b) rested c) situated d) stood
8. They are going to build a big office block on that plot of land.
a) blank b) unusing c) vacant d) void
9. I'm glad I chose this part of town to live in. It's such a peaceful
a) environment b) neighbourhood c) proximity d) surroundings
10. There has been a lot of about the housing shortage in big cities.
a) advertising b) circulation c) communication d) publicity

275. TOWNS AND VILLAGES. *Fill in the sentences.*

1. Erie is the capital of the region. It is, in fact, the only _ _ j _ _ r city in this rural area.
2. _ _ r _ _ _ life is healthy and quiet when compared with life in cities.
3. The house stood by itself in the middle of fields. It was completely _ _ s _ _ _ _ _ _ _ _ .
4. Our city is situated on the west _ _ _ _ _ of the river.
5. Our house is rather difficult to find. I'll draw you a little _ _ _ _ _ to show you the way.
6. Last year we decided to move to the _ _ _ b _ _ _ _ _ as living here will cost much less than living in the centre of the town.
7. I'll always be a c _ _ _ _ _ person. I can't stand the noise and smell of the city.
8. I'm planning a month's walk through the Scottish c _ _ _ _ _ _ _ _ _ _ .
9. Farming here is very difficult because the _ _ i _ _ is very poor.
10. She has just bought a huge _ _ _ _ _ c _ _ of land to build her house on.

*** 276. TOWNS AND VILLAGES.** *Choose the right answer.*

1. Our village is ; some of the houses are very far apart.
a) diffused b) extended c) scattered d) spread out
2. Modern buildings should with the surrounding area.
a) blend in b) join in c) match d) suit
3. Since they built the car factory, a lot of new houses have in the district.
a) hopped up b) jumped up c) leapt up d) sprung up
4. The new town hasn't the usual yet, but a theatre, cinema and library are under construction.
a) aids b) amenities c) conveniences d) equipment
5. When the capital got too crowded, they had to build new towns to take the
a) overfill b) overrun c) overspill d) overstock
6. The monastery is on the of the town.
a) neighbourhood b) outskirts c) suburbs d) surroundings

- * 277. **TOWNS AND VILLAGES.** *Choose the word or phrase that best keeps the meaning of the original sentence if it is substituted for the capitalized word.*
1. The man was **RELUCTANT** to put in a few hours of work in the garden.
 - a) anxious
 - b) cager
 - c) negligent
 - d) unwilling
 2. At first it seemed that the building would be all right but later it was found to need **ALTERATIONS**.
 - a) beautification
 - b) decorations
 - c) modifications
 - d) restoration
 3. The picture is **ASKEW**; please straighten it.
 - a) adjustable
 - b) crooked
 - c) high
 - d) level
 4. There is a large area of **SWAMP** that will have to be cleared before construction can begin.
 - a) dry, sandy soil
 - b) forest
 - c) prairie
 - d) soft wet land
 5. The **STRAY** dog was picked up by the dog catcher because he had no collar.
 - a) dirty
 - b) homeless
 - c) sick
 - d) unfriendly
 6. He **TRAMPED** across the carpet in his boots, leaving a trail of mud behind him.
 - a) limped
 - b) skipped
 - c) walked heavily
 - d) walked unsteadily
 7. Do not leave the iron on that delicate fabric or the heat will **SCORCH** it.
 - a) burn
 - b) melt
 - c) press
 - d) wrinkle
 8. I would like your **PERMISSION** to trim that part of the tree that hangs into my yard.
 - a) approval
 - b) attention
 - c) encouragement
 - d) consent

9. The use of this product for building houses was recently **BANNED** by the Ministry of Health.
- backed
 - prohibited
 - sponsored
 - studied
10. Every year the average family discard about a ton of **TRASH**.
- filler
 - fuel
 - garbage
 - paper

278. TOWNS AND VILLAGES. Crossword.

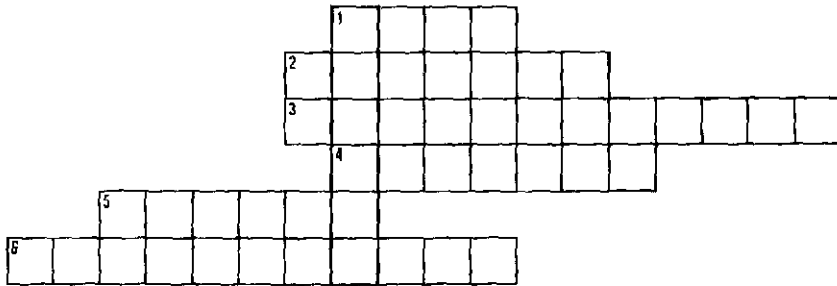

- place where your family lives (4)
- opposite of city (7)
- area near to or round a place (12)
- hills, trees, fields, etc. considered as things to look at (7)
- the world of animals, insects and plants (6)
- hills, trees, fields, etc. make this environment (11)

XII. Money and Banking



Sign in a restaurant: "In God we trust. All others cash."

*

Son : "What is a debtor, Pa?"

Papa: "A man who owes money."

Son : "And what is a creditor?"

Papa: "A man who thinks he is going to get it."

279. MONEY. *Choose the right answer.*

1. When you retire at the age of sixty-five, you receive a(n) from the government.
a) allowance b) fine c) grant d) pension
2. If production in that factory exceeds the target, the workers get a
a) bonus b) donation c) gratuity d) premium
3. Income tax is to one's annual income.
a) associated b) based c) dependent d) related
4. The of living has risen by 25% in the last six months.
a) cost b) expenditure c) expense d) price
5. The kidnappers demanded a of \$ 1,000,000.
a) fine b) penalty c) ransom d) reward
6. The World Bank has criticised the United States for not giving enough financial to the East European countries.
a) aid b) allowance c) loan d) premium
7. You can your basic wage by working longer hours.
a) effect b) help c) implement d) supplement
8. A salesman is paid a on the goods he sells.
a) commission b) percentage c) provision d) salary
9. The President admitted taking and had to resign.
a) bribes b) fees c) fines d) premiums
10. In our country of \$ 250 is paid weekly to a family with more than three children.
a) an allowance b) a fee c) an income d) a wage
11. Mr Mean cannot bear to even the smallest sum of money for a charity appeal.
a) give in b) let out c) part with d) pay off
12. Mr Rich earns \$ 8,000 a month and \$ 5 000 a month net.
a) bulk b) gross c) mass d) wholesale
13. You can only this postal order at a post office.
a) alter b) cash c) exchange d) pay
14. If they are not more careful with their accounts, they will go
a) bankrupt b) broken c) penniless d) poor
15. The Finance Minister will be making a today about new rates of income tax.
a) declaration b) notice c) statement d) talk
16. If I had another \$ 25,000 a year, I would consider myself
a) well deserved b) well done c) well-made d) well off
17. All the workers in our firm get a Christmas of \$ 100.
a) bonus b) fine c) prize d) reward
18. "Can you something for the orphans?" he asked, rattling a collecting-box.
a) give b) leave c) provide d) spare
19. Before starting a business, you have to raise the necessary
a) capital b) currency c) investment d) savings

20. The usual reason for exemption from tax does not in this case.
 a) apply b) concern c) impose d) regard
21. Mrs Unemployed is finding it difficult to pay the on her insurance policy.
 a) bonuses b) fees c) fines d) premiums
22. Our company made a record last year.
 a) benefit b) earn c) profit d) winning
23. While you are away from the office on business trips, you will be given a daily of \$ 50 towards meals and accommodation.
 a) allowance b) fine c) permit d) reward
24. I hate the beginning of each year when all the start coming in and I have to find the money to pay them all.
 a) accounts b) bills c) estimates d) receipts

**** 280. MONEY.** Give the names for the defined money expressions.

- | | |
|--|-----------|
| 1. a fixed amount which is paid, usually monthly, to workers of higher rank | a s _____ |
| 2. an amount of money which you lend to someone | a l _____ |
| 3. a sum of money which is owed to someone | a d _____ |
| 4. money which is in the form of coins and notes, not cheques | c _____ |
| 5. an amount of money you receive, usually weekly, in return for labour or service | a w _____ |
| 6. money paid by divorced father to his former wife for the upkeep of his children | a _____ y |
| 7. tax on imported articles paid to the Customs | _____ y |
| 8. paid at a restaurant after eating | a _____ l |
| 9. extra percentage paid on a loan | i _____ |
| 10. money paid for professional services, e.g. to a doctor | a f _____ |
| 11. money paid by the state, usually to students | a g _____ |
| 12. money paid by a company or the state on your retirement | a p _____ |
| 13. paid as a punishment for breaking the law | a f _____ |
| 14. paid to the government for services that the state provides | _____ s |
| 15. paid while travelling, especially on public transport, buses, trains, etc. | a f _____ |

281. MONEY. Put each of the following words or phrases into its correct place in the text below

banks	beads	buy	coins	change
currency	depositing	earn	exchange rate	
goods	investments	money	paper bills	
savings accounts	sell	shells	value	

Money

Money is what people use to things. People spend money on and services. Many people save part of their money by it in a bank. People money by performing services. They also earn money from , including government bonds, and from can be anything that people agree to accept in exchange for the things they or the work they do. Ancient peoples used such varied things as , , and cattle as money. Today, most nations use metal coins and Different countries' and bills look different and have different names.

A person can his money for the money of any country according to the Usually, such rates are set by the central of a country. The of a country's may change, depending on the economic and political conditions in that country.

**** 282. MONEY.** Match the definitions with the correct money word.

- | | |
|------------------|---|
| 1. an allowance | a) money paid to authors or inventors according to the sales of their work |
| 2. a bonus | b) a sum of money used to make more money from something that will increase in value |
| 3. commission | c) the money which a building society or bank lends to someone to buy a house |
| 4. a deposit | d) the money that a person pays to an insurance company to protect against loss or damage |
| 5. a dividend | e) money, usually from a relative, to live on |
| 6. an investment | f) an additional payment which is a reward to those who work for a company for their extra work |
| 7. a legacy | g) the amount of money borrowed from a bank, greater than that which is in your account |
| 8. maintenance | h) money received from someone in his or her will |
| 9. an overdraft | i) the amount of money that goes to a shareholder |
| 10. a premium | j) money paid by divorced or separated people to support the former husband or wife |
| 11. royalties | k) part of the value of a company that you may buy |
| 12. a share | l) part-payment of money which you make to stop the seller from selling his goods to others |
| 13. a mortgage | m) an amount of money, related to the value of goods sold, which is paid to a salesman for his services |

* 283. MONEY. Choose the correct answer.

1. The going for the job is \$ 7 an hour.
a) pay b) price c) rate d) wage
2. When you buy a house you can claim tax on the mortgage.
a) aid b) assistance c) benefit d) relief
3. Inflation is the first problem that the new government will have to
a) clasp b) grasp c) seize d) tackle
4. Mr Teenager's will be held in trust for him until he is 21. Then he will be free to spend it.
a) dowry b) heirloom c) heritage d) inheritance
5. When the company was declared bankrupt, all its fixed were claimed by its creditors.
a) assets b) benefits c) funds d) sums
6. Our country has never had a large in its balance of payments.
a) abundance b) addition c) overflow d) surplus
7. Miss Cheating is in trouble because she has not paid her National Insurance for ten years.
a) contributions b) subscriptions c) subsidies d) tributes
8. People in financial difficulties sometimes fall to unscrupulous money lenders.
a) fool b) prey c) sacrifice d) scapegoat
9. Because Mr Sacked has just lost his job, his aunt's legacy came as a useful
a) advantage b) benefit c) profit d) windfall
10. The government has introduced currency controls which will make it more difficult to holiday abroad.
a) extreme b) striking c) stringent d) strong
11. If you don't complete your income tax , you may have to pay more than is necessary.
a) account b) document c) report d) return
12. As a result of increased productivity, the workers received a pay increase.
a) fundamental b) palpable c) substantial d) tangible
13. \$ 150? \$ 250? Let's the difference and say \$ 200.
a) agree b) avoid c) decrease d) split
14. Newly coins always look clean and shining.
a) minted b) moulded c) pressed d) printed
15. For some jobless people, joining the queue is a humiliating experience.
a) benefit b) dole c) grant d) ration
16. If a man is legally separated from his wife, is he still for her debts?
a) answerable b) bound c) chargeable d) liable
17. The two men a coin to see who should take care of the business on the weekend.
a) hurled b) lobbed c) threw d) tossed
18. No-one knows precisely how much she earns a month, but \$ 4,000 can't be very of the mark.
a) broad b) distant c) far d) wide

19. The between the rich and the poor is very evident in the Western World.
a) deviation b) differentiation c) difference d) distance
20. The salary is \$35,000 per annum, with annual of \$2,000 for five years.
a) annexes b) bonuses c) increments d) prizes
21. The government's policy is to firms in trouble to prevent unemployment.
a) contribute b) endow c) grant d) subsidise
22. Being a teacher, I shop at stores which offer a to teachers.
a) deduction b) discount c) rebate d) subsidy
23. Share prices on the Stock Exchange plunged sharply in the morning but slightly in the afternoon.
a) recovered b) regained c) restored d) retrieved
24. The firm will go bankrupt if it cannot meet its
a) charges b) duties c) liabilities d) promises
25. Mr Businessman needed \$10,000, but as his capital was up in shares, he borrowed it from his bank.
a) bound b) knotted c) locked d) tied

284. MONEY. Complete. Each (---) represents one letter.

1. I spend about \$1.5 a week on bus --- es.
2. I had to pay --- on the Turkish carpet I brought in through the Customs yesterday.
3. Now that Mr Old has retired, he lives partly on his --- s --- and partly on the --- t --- from his post office savings account.
4. In spite of its size his family was quite --- off, because he brought in a good --- l ---.
5. Gold would be a good --- v --- t; it's bound to increase in value.
6. Due to inflation the --- of living went down by fifteen --- c ---.
7. I couldn't buy the house because the bank refused to let me have a m --- g ---.
8. If you borrowed money from him, you are under an --- l --- to give it back.
9. You must stop wasting your money on silly things and start --- v ---. This is the only solution to your --- n --- troubles.
10. One dollar is --- u --- to over 20,000 zł.
11. The main advantage of a --- u --- book or --- d --- card is that you don't have to carry cash around with you.
12. I carry loose change in my pocket and --- s in my leather --- l ---.

285. BANKS. Choose the correct answer.

1. Every Friday Fred money out of the bank.
a) cashed b) drew c) robbed d) stole
2. The of the pound has fallen recently.
a) expense b) price c) value d) worth

3. In order to buy his house Mr Not-Too-Rich had to obtain a large from his bank.
a) capital b) debt c) finance d) loan
4. The accounts show a of \$ 500 this month.
a) decrease b) deficit c) deterioration d) devaluation
5. Violetta drew all her savings from the bank to pay for her trip to Thailand.
a) along b) in c) out d) up
6. The bank will require three signatures when you open an account.
a) natural b) sample c) specimen d) trial
7. Miss Thrifty phoned the bank to how much money there was in her account.
a) check b) control c) inspect d) test
8. Corruption in the running of the town's largest bank has recently been in the local newspaper.
a) commented b) discovered c) exposed d) found
9. Many people save money to for their old age.
a) cater b) equip c) provide d) supply
10. Mr Royce had to all his savings from the bank to pay for a new car.
a) exchange b) retire c) subtract d) withdraw
11. The bank is offering a to anyone who can give information about the robbery.
a) compensation b) prize c) premium d) reward
12. The of the bank where I work is in the suburbs.
a) branch b) house c) quarter d) seat
13. I didn't write it. That's not my on the cheque.
a) firm b) letter c) mark d) signature
14. I'm afraid that the bank will refuse my application for an extended
a) balance b) compensation c) estimate d) overdraft
15. At this bank you can get 14% on your savings.
a) interest b) rate c) rent d) salary
16. I want \$ 500-worth of French francs. What is the rate, please?
a) currency b) exchange c) market d) money
17. Miss Positive the bank manager that she would be able to repay the loan.
a) assured b) ensured c) certified d) insured
18. The debt should be paid within thirty days of receiving this statement.
a) all over b) as a whole c) for good d) in full
19. I have just an account in this bank.
a) entered b) made c) opened d) registered
20. Miss Thrifty only \$ 15 out of the bank every week.
a) draws b) extracts c) pulls d) removes
21. Please complete the form and return it to the branch manager.
a) encased b) enclosed c) enveloped d) inserted
22. We to inform you that settlement of your account is three months overdue.
a) apologize b) are displeased c) dislike d) regret

23. \$1 is to 1.6 German marks.
 a) comparable b) changeable c) equivalent d) variable
24. We cannot give you the money until you show us some form of : a passport or a driving licence will do.
 a) identification b) identity c) paper d) surety

286. BANKS. Put each of the following words or phrases into its correct place in the text below.

account	bank	bank income	credited	creditor
debtor	deposit	depositors	funds	hide
interest	loan	paid	pocket	record
safekceping	save	spend	withdraw	

Banks

People money in banks for future use. A man may be each week for his work. He probably will not want to all his pay the day he receives it. It may be risky for him to carry all his unspent money in his , or to it at home. So he may decide to put some of his money in a bank for The money he puts in the bank is called a This money is , or added, to his An account is a of the money a depositor has in the bank. When the depositor wants to , or take out, part of his deposit, the must be ready to pay him.

Banks use the money of for loans to those who need The bank that makes the loan is called a lender, or The bank charges the borrower, or , interest for the use of the Charging for the use of money is the chief source of

*** 287. BANKS.** Choose the correct answer.

1. Please find enclosed our scale for life insurance premiums.
 a) gauging b) raising c) sliding d) slipping
2. My enquiries did not any information of value.
 a) affect b) arouse c) elicit d) extort
3. His bank manager decided to give him financial for the new shop.
 a) backing b) footing c) lifting d) standing
4. Many people who go to see their bank manager have a problem.
 a) cash-book b) cashing up c) cash flow d) petty cash
5. Reminders must be sent out to all customers whose accounts are more than a month
 a) indebted b) overdue c) unbalanced d) unpaid
6. The notes in the wallet were all American dollars.
 a) counterfeit b) false c) mimic d) mock

XIII. Plants

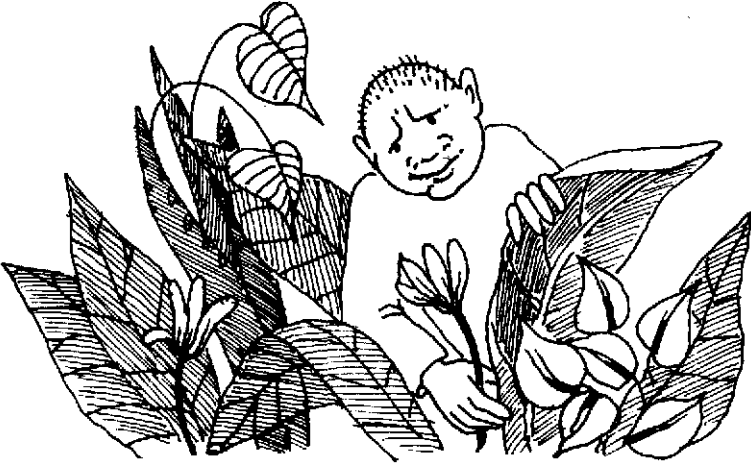

Judge: "Why did you throw the pot of geraniums at the plaintiff?"

Accused: "Because of the advertisement, your honour."

Judge: "What advertisement?"

Accused: "Say it with flowers."

*

A woman's mouth is like a rosebud until a man marries her. Then the bud opens...

**** 288. PLANTS.** Put each of the following words and phrases in its correct place in the passage below.

bacteria	breeds	cheese	forests
fungi	grasses	plant kingdom	plants
rocks	scientists	seed-bearing	shrubs
species	stems	varieties	world

Kinds of Plants

..... know that there are more than 335,000 different of plants. Actually, if we travelled all over the we could see more different kinds of plants than these, but some of these are merely, as much as dogs are merely different of one basic kind of animal.

The simplest plants found in the are one-celled and algae, and that are like the moulds often seen growing on bread and

The next group of relatively simple includes the mosses and lichens that are found in, on bare, on rooftops, and elsewhere. Some of these plants have and leaves, but no roots. After that, the next group includes ferns and bracken. Finally, there is the group of plants. Such plants include our common and vegetables, and most trees, and flowers.

289. PLANTS. Choose the right answer.

- The little boy climbed up the tree and sat on a
a) branch b) root c) twig d) trunk
- I think the birds must have eaten all the seeds I last month!
a) sawed b) sewed c) showed d) sowed
- They spent the afternoon blackberries in the wood.
a) cutting b) gaining c) picking d) taking
- It was spring, and the flowers were
a) coming out b) going out c) growing up d) raising
- It is difficult to grow good vegetables in the poor in this area.
a) crust b) dirt c) soil d) strand
- You will have to those apple trees if you want a good crop of apples next summer.
a) cut b) fell c) prune d) wash
- If in March, they should give a host of splendid blooms a few months later.
a) dug b) earthed c) installed d) planted
- You will need a strong if you are going to dig that hard ground.
a) hoe b) ladle c) rake d) spade
- You should plant in the autumn if you want the flowers to appear in the spring.
a) bulbs b) roots c) stalks d) twigs
- There is a of plant which is found only in this particular area.
a) breed b) class c) specimen d) species

11. Sugar is more expensive now because there was a very poor sugar-beet last year.
a) collection b) crop c) gathering d) production
12. The flowers in this vase have
a) dimmed b) dulled c) faded d) shaded
13. I want some roses with nice long, please.
a) branches b) feet c) stems d) trunks
14. Why don't you some flower seeds in that patch of ground by the garden gate?
a) bed b) dig c) set d) sow
15. He stood up and leant against the of the tree.
a) body b) figure c) root d) trunk
16. You shouldn't hack the off trees. They might die.
a) bark b) crust c) peel d) rind
17. grows only in a hot climate.
a) Cotton b) Linen c) Silk d) Wool
18. There are a lot of red on that holly bush.
a) acorns b) berries c) currants d) nuts
19. The corn was not ready for cutting as the ears were still
a) undeveloped b) unprepared c) unripe d) unsteady
20. Some trees their leaves in winter.
a) fell b) leave c) shed d) throw

290. PLANTS. *Put each of the following words into its correct place in the passage below.*

agriculture	bright	darkness	enormous
environment	horticulture	hot	imaginable
naked	pine	science	seaweed
small	snow	yeast	

The Appearance of Plants

Plants can be almost any colour They may be, or so small that you cannot see them with the eye. A giant is just as much a plant as a tree, plant, or a bacterium which is too to see.

Some plants flourish in climates, while others live equally successfully on and ice. Some carry out their life processes in total, while others are at their best in sunlight.

A whole known as ecology has grown up to help us understand the relationship between the and living things there., forestry, and are the sciences of learning how to make living things do what we want them to do in a given place.

**** 291. TREES.** Give the Polish name of the following trees.

- | | |
|-------------|---------------|
| 1. ash | ___ s ___ n |
| 2. aspen | o _____ |
| 3. birch | _____ o _____ |
| 4. chestnut | _____ a ___ |
| 5. elm | _____ z |
| 6. fir | ___ o _____ |
| 7. hazel | ___ s _____ |
| 8. larch | ___ d _____ |
| 9. linden | _____ a |
| 10. maple | _____ o ___ |
| 11. oak | _____ |
| 12. pine | _____ a |
| 13. poplar | _____ o _____ |
| 14. walnut | _____ c _____ |
| 15. willow | ___ e _____ |

**** 292. TREES.** Which of the above trees are deciduous, which coniferous, and which evergreens?

*** 293. PLANTS.** Put each of the following words and phrases into its correct place in the passage below.

air	branching head	climb	erect	ground
liquids	reproduction	shrubs	soft	spread
storage	tall	tissue	trunk	woody plants

Stems

Stems are parts of plants that may be organs of food or of They may be useful in moving from one part of the plant to another, or they may merely hold certain parts high in the

The of stems may be and weak or hard and woody. The different groups of are vines, trees, and shrubs.

Vines are rarely They wind, or over some support. Trees have a single trunk, with a and are, when mature, normally over three metres , on the other hand, do not have a They usually branch close to the and are not very tall.

**** 294. STAGES IN THE LIFE-CYCLE OF A PLANT.** *Put the following stages of the life-cycle of a plant in the correct order.*

- | | |
|-------------------------|---------------------------------|
| 1. First, | a. flowers appear. |
| 2. Next, | b. the fruit forms. |
| 3. Soon, | c. germination begins. |
| 4. At this stage, | d. leaves also start to sprout. |
| 5. Subsequently, | e. the plant decomposes. |
| 6. Meanwhile, | f. the plant dies. |
| 7. Later, | g. pollination takes place. |
| 8. Then, | h. roots begin to develop. |
| 9. During this process, | i. the seed begins to swell. |
| 10. Afterwards, | j. the seed is sown. |
| 11. Eventually, | k. the seed needs water. |
| 12. Finally, | l. the stigma receives pollen. |

*** 295. PLANTS.** *Choose the right answer.*

- One of the effects of acid rain is that it causes plants to
a) contract b) shrink c) thrive d) wither
- Owing to the warm weather, there has been of strawberries this year.
a) an affluence b) a glut c) an overflow d) a redundancy
- Our grandpa's sitting over there in the shade in the middle of that of trees.
a) bundle b) clump c) scrub d) stack
- We thought the plants had all died from lack of rain, and were delighted to see new appearing.
a) points b) shapes c) shoots d) tops
- Oak and beech are
a) bushes b) coniferous trees c) deciduous trees d) shrubs
- Those could be delicious fried in butter for dinner.
a) ferns b) fungi c) mosses d) mushrooms
- A green carpet of covered the decaying tree trunk.
a) herb b) moss c) shrub d) turf
- When the wind blows, you can hear the leaves
a) cracking b) creaking c) rattling d) rustling
- The indiscriminate use of pesticides has many rare species.
a) cancelled b) devastated c) extincted d) wiped out
- Waste paper can be instead of being burnt.
a) decomposed b) incinerated c) recycled d) revamped
- Don't eat those berries in case they are
a) contagious b) infectious c) poisonous d) venomous
- Several of the trees in the park were
a) diseased b) ill c) sick d) unhealthy

**** 296. HERBS.** Put each of the following words and phrases into its correct place in the passage below.

biennials	blades	classified	flavour	fleshy
life-cycle	mature	medicines	perennial	scent
seasons	seed	value	year	

Herbs

Herb is a low-growing plant that has a or juicy stem when it is young. The word *herb* comes from Latin word *herba*, meaning "grass" or ".". Some herbs are used in cooking. Although they have little food , they make food tasty and full of Other herbs give to perfumes. Others still are used for

Herbs are frequently as annuals, , and perennials. An annual goes through its from seed to in a year. A biennial requires two to complete the cycle. A may live many seasons, producing seeds after year once the plant has become

*** 297. PLANTS.** Choose the word that best keeps the meaning of the original sentence if it is substituted for the capitalized word or phrase.

1. The walnut is a deciduous tree that **BEARS** valuable nuts.
 - a) enriches
 - b) hides
 - c) replaces
 - d) yields
2. The orchid is an **EXOTIC** plant to see blooming in many European gardens.
 - a) a beautiful
 - b) a colourful
 - c) a common
 - d) an unusual
3. The rose may grow as a low bush or as a tree, depending on how it is **PRUNED**.
 - a) nourished
 - b) planted
 - c) trimmed
 - d) watered
4. The flowers will **WITHER** in a few hours.
 - a) bloom
 - b) dry up
 - c) open
 - d) revive
5. The needle-like leaves of the giant redwood tree are **MINISCULE**, each scarcely a quarter of an inch long.
 - a) pretty
 - b) thorny
 - c) tiny
 - d) wiry

6. Leeks are CULTIVATED throughout much of the world.
 - a) cooked
 - b) dried
 - c) grown
 - d) seen
7. The principal areas inhabited by marine algae are rocky SHORES, salt marshes, and shallow water.
 - a) cliffs
 - b) coasts
 - c) pools
 - d) rivers
8. Soot STICKS TO anything it touches.
 - a) blackens
 - b) clings to
 - c) points to
 - d) streaks
9. The flower is the MOST ATTRACTIVE, most colourful and most fragrant part of many plants.
 - a) prettiest
 - b) rarest
 - c) softest
 - d) strongest
10. Roses are POPULAR flowers in Polish gardens.
 - a) accustomed
 - b) favourite
 - c) ordinary
 - d) vulgar

XIV. Post Office and Telephones



A lady had just purchased a postage stamp: "Must I stick it on myself?" she asked.

"Definitely not, madam," replied the postal clerk. "It will accomplish more if you stick it on the envelope."

*

Teacher (answering the telephone): "You say Johnnie Black has a bad cold and can't come to school? Who is this speaking?"

Voice: "This is my father."

298. POST OFFICE. *Choose the right answer.*

1. Don't forget to the letter before you post it.
a) do up b) fasten c) seal d) shut
2. They my letter by return of post.
a) acknowledged b) posted c) registered d) thanked
3. He was always about addressing letters.
a) carefree b) careless c) free d) reckless
4. If you send the letter here, my mother will it to my new address.
a) advance b) forward c) transfer d) transmit
5. I had to sign for this letter because it came in a envelope.
a) receipted b) recommended c) registered d) sealed
6. She the letter carefully before putting it in the envelope.
a) bent b) curved c) folded d) turned
7. In Britain the on a letter is now about 40 pence.
a) post b) postage c) postal d) posting
8. It is very easy to lose one's with post-office officials.
a) humour b) mood c) temper d) nature
9. I would be if you could answer my letter by return.
a) cheerful b) glad c) good d) kind
10. Would you the stamps on the envelope for me, please?
a) lick b) spit c) stick d) suck
11. Mail is to one's house by a postman.
a) delivered b) launched c) posted d) sold
12. Stick this that says "Fragile" on the parcel.
a) advice b) advertisement c) label d) sign
13. He opened the letter without to read the address on the envelope.
a) bothering b) caring c) fearing d) worrying
14. What time does the next post ?
a) depart b) go c) remove d) take
15. The postman usually comes at about 9 o'clock with the first
a) courier b) delivery c) distribution d) postage
16. Can you deliver this letter hand?
a) by b) in c) to d) with
17. The initials "PS" "postscript".
a) fill in b) make up c) mean to d) stand for
18. Just lick the gummed part of the and stick the envelope down.
a) flap b) frame c) slot d) tray
19. The postal services were for several weeks by the strike.
a) deranged b) disarrayed c) disrupted d) perturbed
20. The post office is open for the sale of postage stamps.
a) a day b) daily c) daytime d) in day

299. POST OFFICE AND MAIL. Answer the clues. The number of letters is given.

1		P	_____
2		O	_____
3		S	_____
4	_____	T	_____
5	_____	A	_____
6	_____	L	_____
7	_____	S	_____
8		E	_____
9	_____	R	_____
10	_____	V	_____
11	_____	I	_____
12		C	_____
13	_____	E	_____

1. the money you have to pay for the stamp (7)
2. you usually send your letters not by special delivery but by mail, first or second class (8)
3. each letter or postcard must have it before it is sent (5)
4. used instead of a letter, with a photograph or picture on one side (8)
5. another word for „post”, often used in American English (4)
6. box into which letters are dropped for collection, red in Britain (9)
7. person who delivers letters and parcels (7)
8. special post which — for an extra charge — ensures compensation if the letter or parcel is lost (10)
9. the person you send your letters to (9)
10. take letters or parcels to persons to whom they are addressed (7)
11. newspapers and magazines sent by post are called matter (7)
12. group of letters and numbers used to make the sorting and delivery of mail easier (4)
13. things wrapped and tied up for sending by post; package (6)

300. TELEPHONE. Put each of the following words or phrases into its correct place in the passage below.

charge reversed	connection	dial
direct	directory enquiries	engaged
international code-number	lift	long-distance
message	number	operator
person-to-person	receiver	telephone directory
wrong number		

Making a Telephone-call

When you make a telephone-call you the receiver. Then you the number. If you don't know the you can look it up in the If you can't find it there you can call

Making a call to a place far away is called a call. For most countries in Europe you can phone ; first dial the

If you don't have enough money you can ask for a call and have the This means that the of the call has to pay for it.

When there is a difficulty with the the may tell you to hold the line. If the person you want to call is already speaking to someone, the number is

When you call a friend and somebody else answers the phone, you can leave a , or it may mean that you have dialled a

301. TELEPHONE. *Choose the right answer.*

1. If you don't remember the number, you can look it up in the telephone
a) dictionary b) directory c) index d) register
2. Mr Suspicious alleged that his phone had been
a) connected b) encoded c) planted d) tapped
3. Can you a pound? I need some money for the telephone box.
a) change b) exchange c) offer d) spend
4. Can you Prof. Brown's telephone number?
a) call to mind b) recall c) remember d) remind
5. His phone must be out of order. We've been unable to him.
a) arrive at b) meet c) reach d) transmit
6. Would you a minute, please. I'll try to connect you.
a) hold on b) keep on c) stay on d) stop on
7. Can I London direct from here, or must I ask the operator to get the number for me?
a) choose b) dial c) reach d) select
8. The human voice often sounds on the telephone.
a) deformed b) distorted c) irregular d) twisted
9. My telephone is so I shall have to ask my neighbour if I can use his.
a) off duty b) off limits c) out of order d) out of use
10. Where are you calling from? I can hardly hear you. Your voice is terribly
a) dull b) fade c) faint d) pale
11. I'm sorry. No one called Mimi lives here. You must have the wrong number.
a) dialled b) fingered c) pressed d) pushed
12. Mrs Hello works as an operator at the local telephone
a) centre b) exchange c) headquarters d) office
13. I phoned him this morning but when I said who I was he
a) hung up b) rang up c) shut down d) shut up
14. The telephone operator said she would put the caller when the line was free.
a) forward b) in c) through d) up
15. I let the telephone ring several times before I the receiver.
a) lifted away b) picked up c) raised up d) took out

16. Jenny! Your boyfriend called and asked me to give you a
a) greeting b) message c) news d) notice
17. It is very difficult to phone you in London as your number is always
a) busy b) engaged c) occupied d) taken
18. I was in the middle of phoning Pete when we were
a) cut down b) cut in c) cut off d) cut up
19. In the middle of the call the line went
a) dead b) deaf c) dumb d) flat
20. Is there a phone anywhere near here, please?
a) box b) compartment c) room d) shop
21. Hello! The University? Could I speak to Prof. Wise on 233, please?
a) branch b) exchange c) extension d) system
22. "All the telephone lines are," said the operator.
a) detached b) disconnected c) disunited d) severed
23. I his telephone number while he was still talking.
a) dashed off b) jotted down c) set down d) wrote up
24. I've tried ringing four or five times, but I still can't that Warsaw number.
a) get on to b) get through to c) go along with d) go on to

302. TELEPHONE ETIQUETTE. Put each of the following words or phrases into its correct place in the passage below.

answer	call	caller	come through	directory
hang up	identify	message	mouthpiece	number
operator	reach	receiver	replaced	ring
save	telephone	tone		

Telephone Etiquette

1. Know the right number before making a When in doubt, consult a , your personal number list, or the information
2. Allow time to Give the person you are calling enough time to his telephone. A little patience may you a second call.
3. Speak distinctly and in a normal of voice. Your lips should be about an inch away from the
4. Answer promptly. Try to answer your telephone on the first Otherwise the may hang up and you might miss an important message.
5. yourself when you answer the Do not merely say "Hello". Give your name, your telephone , or the name of your firm.
6. Take messages for people who are not there. Write down the name and telephone number of the person calling. Place the where it can be seen.
7. gently. Slamming the down is discourteous. Be sure the receiver is always properly. Otherwise no calls can to you.

XV. Religion

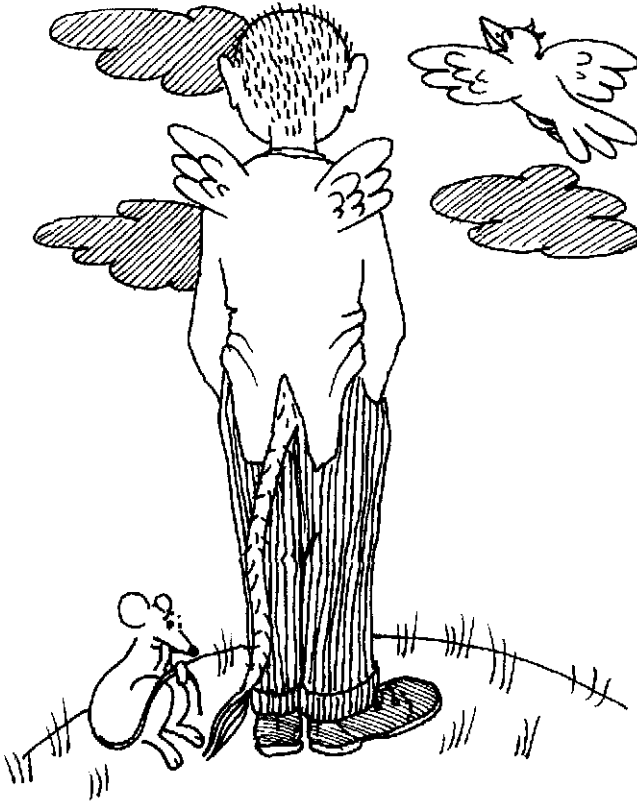

A Catholic priest and a Protestant minister had a long argument about their respective beliefs. At last they agreed to differ. In parting, the priest said:
„You worship God your way, I'll worship Him His way.”

*

A pastor, examining a Sunday School class in religious knowledge, asked the following question of a little girl:

„What was the difference between Noah's Ark and Joan of Arc?”

He was not a little surprised when the child said: „Noah's Ark was made of wood and Joan of Arc was maid of Orleans.”

303. CHURCH. Match the names of objects with the right number.

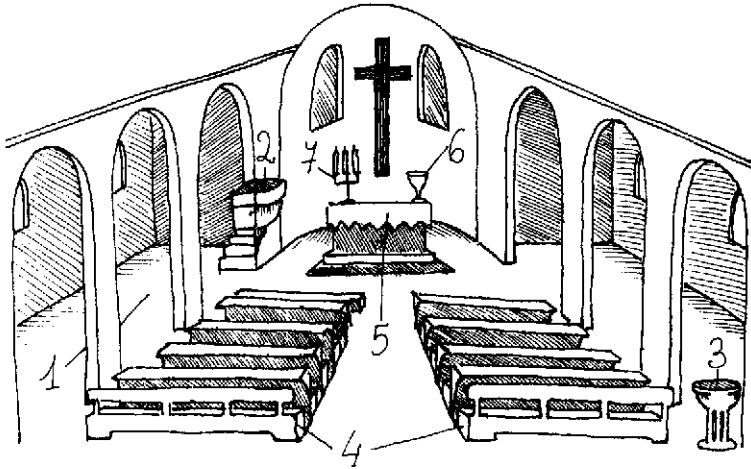

- | | |
|-----------------|------------|
| ... aisle | ... font |
| ... altar | ... pew |
| ... candlestick | ... pulpit |
| ... chalice | |

304. RELIGION. Complete the following sentences with the given words.

- | | | | | |
|----------|----------|-----------|--------------|---------|
| angels | blessing | cardinals | congregation | convert |
| Creation | Devil | diocese | gospels | heaven |
| hell | mass | paradise | parish | prayers |
| saints | sermon | service | sins | worship |

1. A bishop is the head of a
2. The district in the care of a vicar is a
3. God lives in surrounded by and
4. In the Roman Catholic Church the pope is elected by the
5. A church is a place of
6. You usually go to church to attend a , which in the Roman Catholic Church is called
7. During the mass we say , and the priest gives a
8. At the end of the service the vicar gives the his
9. The first book of the Old Testament, Genesis, tells us about the
10. Adam and Eve lived in the Garden of Eden or
11. The first four books of the New Testament are called the
12. The bad things we do are called
13. God's opponent is the and he lives in
14. Someone who has become a believer is a

* 305. **CHRISTIANITY.** Put each of the following words into its correct place in the passage below.

ascended	apostles	blasphemy	brotherhood	Christian
condemned	creatures	crucified	dead	deliverer
disciples	doctrines	Easter	followers	heaven
humility	leaders	preaching	prophets	religion
resurrection	uprising			

Christianity

Jesus Christ founded the Christian He began His teaching in Palestine, instructing and to people about the Kingdom of He travelled around the country with a group of called disciples. He chose 12 disciples, called , to preach His doctrine. Like the Old Testament , Jesus insisted upon justice toward men and toward God. He also preached mercy and the of men, and told of the love of for all

The Jewish religious of Jesus' time did not approve of His claim that he was the Messiah, or the promised of the Jews. They considered this action to be The Roman authorities feared that He meant to lead an against Roman rule in Palestine. As a result, He was tried, to death, and

After the death of Jesus, His scattered in fear. However, they soon reassembled. One after another of them, beginning on the first morning, reported that they had met Jesus alive. This rising from the is called the Resurrection, and forms one of the basic of the Christian faith. According to teaching, Jesus remained on earth for 40 days after His , and then into Heaven.

** 306. **RELIGIONS.** Which religion or church are these figures connected with? In some cases the same person is connected with more than one faith.

- | | |
|---------------|---------------------------------|
| 1. archbishop | a. Church of England (Anglican) |
| 2. bishop | b. Buddhism |
| 3. brahmin | c. Hinduism |
| 4. curate | d. Islam |
| 5. dean | e. Judaism |
| 6. elder | f. Lutheran Church |
| 7. lama | g. Presbyterian Church |
| 8. minister | h. Roman Catholic Church |
| 9. mullah | i. Russian Orthodox Church |
| 10. priest | |
| 11. ayatollah | |
| 12. pope | |
| 13. rabbi | |
| 14. guru | |
| 15. vicar | |

* 307. CHURCH. Put each of the following words into its correct place in the passage below.

Anglican	bishop	cathedral
choirmaster	clergymen	layman
rectory	vicar	

The Clergymen of the Church of England

Here are Church of England, or Church, , arranged in order of importance: an archbishop, a , a vicar, a curate. A is sometimes called a rector, and his house a vicarage, or a A dean is the clergyman in charge of a A churchwarden is a (not a clergyman) who shares responsibility for church business matters. The organist plays the organ and the trains the church choir.

** 308. RELIGION. Which religion is characterized by the following names or expressions?
Which is the odd man out?

1. Christ; Gospels; Resurrection; church; reincarnation; Holy Spirit; baptism; Ten Commandments
2. Muhammad; Koran; Jesus; curate; muezzin; mosque; Muslim; Ramadan
3. Moses; Tora; the Promised Land; Ark of the Covenant; saints; synagogue; the Holocaust
4. Vedas; yoga; Ganges River; church; reincarnation; temple
5. The Buddha; baptism; reincarnation; lama; pagoda; nirvana

309. RELIGION. Choose the right answer.

1. The vicar conducted the in the church.
a) class b) lecture c) meeting d) service
2. The lighted candles on the altar in the draught from the open window.
a) flickered b) shivered c) trembled d) wavered
3. Some people have their told because they want to know the future.
a) chance b) destiny c) fortune d) fate
4. They say that the ghost of a nun the convent at night.
a) displaces b) haunts c) parades d) displaces
5. The listened attentively to every word of the preacher.
a) audience b) congregation c) sightseers d) spectators
6. The approach to the temple was with marble.
a) coated b) faced c) paved d) plated
7. Early man used to the sun, moon, trees and stones as his gods.
a) admire b) consider c) serve d) worship
8. An old on the gravestone gave the names of the deceased.
a) inscription b) label c) plaque d) sign

9. The Hindus are forbidden by their to kill cows and eat beef.
a) belief b) confession c) doctrine d) religion
10. In Britain, members of the usually wear a special white collar that fastens at the back of the neck.
a) church b) clergy c) priests d) vicarage
11. The chapel was built as a to those who died in the war.
a) memorial b) memory c) remembrance d) souvenir
12. Although he never claimed to be he attended church every Sunday.
a) holy b) moral c) religious d) spiritual
13. The service was held to the sacrifice of those who had died in the uprising of 1864.
a) commemorate b) memorise c) remember d) remind
14. Do you really believe in the of the evil eye?
a) being b) existence c) occurrence d) realism
15. The yearly procession to the temple in honour of the local deity was an important religious in that city.
a) activity b) fast c) festival d) habit

**** 310. RELIGION. Put into the usual order.**

- | | |
|---------------------------|-------------------|
| 1. absolution | 5. penance |
| 2. confession | 6. sin |
| 3. determination to atone | 7. sorrow for sin |
| 4. Holy Communion | 8. temptation |

*** 311. RELIGION. Choose the right answer.**

1. There are some interesting old on the tombstones in St Mary's churchyard.
a) epigrams b) epilogues c) epitaphs d) epitomes
2. They say that this house is , but I have lived here for a few years and I have never seen a ghost.
a) cursed b) dangerous c) enchanted d) haunted
3. I'm afraid I'm rather about the existence of ghosts.
a) adaptable b) incapable c) partial d) sceptical
4. They are so concerned with day-to-day problems that they never stop to think about God.
a) agnostic b) devilish c) mundane d) sceptical
5. At the memorial service, the priest paid to the actor's outstanding contribution to the Polish theatre.
a) acknowledgement b) homage c) recognition d) tribute

6. On religious feast days a(n) of the local saint is carried in procession through the streets of the town.
a) copy b) design c) effigy d) reproduction
7. In the Middle Ages many people made a pilgrimage to at the shrine of their favourite saint.
a) devote b) revere c) sanctify d) worship
8. Priests like to remind us that life is
a) passing b) short-term c) temporary d) transient
9. After the church service, several people outside to chat.
a) lagged b) lapsed c) lingered d) loitered
10. The temple was furnished with golden and jewelled statues.
a) decorously b) economically c) lavishly d) wealthily

XVI. Sea Travel

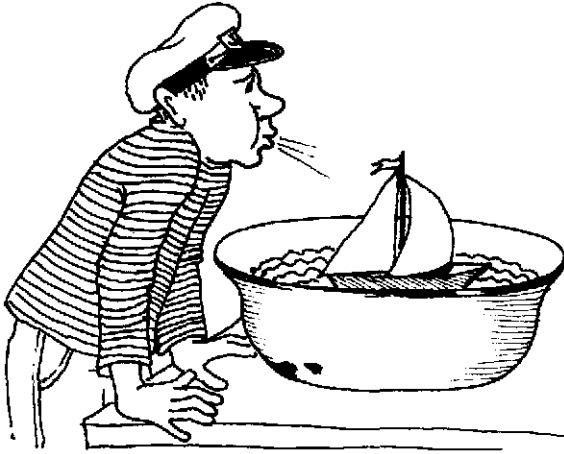

Sailor: "My word, but I'm thirsty."

Steward: "Wait a minute and I'll bring you some water."

Sailor: "I said thirsty, not dirty."

*

A sailor's enlistment in the navy expired. A friend asked him what he thought of the sea.

"Just this much," he said. "I'm going to put an oar over my shoulder and start walking inland — and I'm going to keep on walking and walking and walking until someone stops me and asks: 'What's that thing you've got over your shoulder?' Then I'm going to settle down right there until I die."

312. SHIPS AND BOATS. *Where would you be likely to see the following ships or boats?*

	river	canal	lake	sea	ocean	harbour	underwater
a barge							
a cargo boat							
a ferry							
a liner							
a rowing boat							
a submarine							
an oil tanker							
a yacht							

313. SHIPS AND BOATS. *Choose the correct answer.*

- The river is so here that you cannot use even a little boat.
a) flat b) narrow c) shallow d) straight
- In spite of the storm, the Captain the ship safely into port.
a) directed b) drove c) managed d) steered
- There was a toy boat floating on the of the water.
a) bottom b) flat c) surface d) upper
- He stood on the of the river, looking down into the water.
a) bank b) beach c) border d) coast
- Hold on to your lifebelt, otherwise you'll sink.
a) firm b) steady c) strong d) tight
- There was a terrible storm at sea last night and one of the boats
a) dived b) drowned c) floated d) sank
- The route into the harbour was marked by a line of
a) buoys b) compasses c) lightships d) signposts
- There were a number of fishing boats in the harbour.
a) attached b) fixed c) moored d) roped
- We're going to a cruise on the river next weekend.
a) go b) sail c) take d) travel
- The crew the sinking ship as fast as they could.
a) abandoned b) escaped c) quit d) surrendered
- Keep ! Don't panic! You will soon be rescued!
a) brave b) calm c) firm d) happy
- We have been unable to make with the ship by radio for the last two days.
a) communication b) connection c) contact d) link
- The old sailor away at his pipe, surrounded by a cloud of tobacco smoke.
a) blew b) gasped c) puffed d) snorted

314. SHIPS AND BOATS. *What are the following ships or boats usually used for?*

- | | |
|-----------------|------------------|
| 1. a barge | 5. a rowing boat |
| 2. a cargo boat | 6. a submarine |
| 3. a ferry | 7. a tanker |
| 4. a liner | 8. a yacht |

**** 315. SHIPS AND BOATS.** *Which of the following ships or boats would have funnels, guns, masts, oars, passengers?*

	funnels	guns	masts	oars	passengers
a barge					
a cargo boat					
a ferry boat					
a liner					
a rowing boat					
a submarine					
an oil tanker					
a yacht					

316. SHIPS AND BOATS. *Choose the correct answer.*

- Swimming across that river was a thing for him to do.
a) dangerous b) rough c) stormy d) violent
- I'm always seasick when the sea is
a) calm b) rough c) unsteady d) wild
- The "Anna Maria" from Gdańsk at 11:00 tomorrow.
a) embarks b) leaves c) sails d) steams
- The passengers amused themselves playing games on the upper of the ship.
a) deck b) dock c) floor d) platform
- We saw ships from all over the world in the
a) beach b) harbour c) pier d) shelter
- I don't want to go into the sea. I'd rather lie on the
a) bank b) beach c) coast d) seaside
- You must keep in the boat otherwise it will overturn.
a) balanced b) stiff c) still d) straight
- The boat turned over and sank to the
a) base b) basis c) bottom d) ground
- The ship's captain and members of the welcomed us on board.
a) cast b) crew c) staff d) team

10. In spite of the terrible storm, the ship was
 a) unbroken b) undamaged c) unhurt d) uninjured
11. During the twenty-day cruise, ten will be spent sea, and ten in port.
 a) at b) by c) in d) over
12. Although he shouted, his words were in the wind.
 a) drowned b) killed c) lost d) stopped

** 317. SHIPS. Match the indicated parts of the ship with the right names.

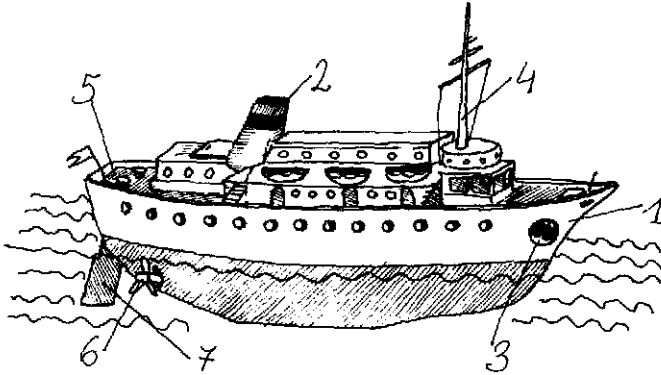

- ... anchor ... bow ... funnel ... mast
 ... propeller ... rudder ... stern

* 318. SHIPS AND BOATS. Choose the correct answer.

1. "Do you row?" "I used to, but I haven't used a pair of for years."
 a) oars b) paddles c) poles d) rows
2. The sea was so that some of the passengers in the pleasure boat felt seasick.
 a) breezy b) choppy c) runny d) wavy
3. They moored the boat to a tree and left it by the river bank.
 a) branch b) log c) pole d) stump
4. They loaded the for the voyage onto the ship.
 a) food b) meals c) portions d) rations
5. The ship ran on the beach near the harbour.
 a) aback b) adrift c) afloat d) aground
6. That boat has an motor at the back.
 a) outboard b) outgoing c) outside d) outward
7. At first sight the island seemed to be bare and of any kind of vegetation.
 a) absent b) devoid c) minus d) vacant

8. The captain realised that unless immediate action was taken to discipline the crew, there could be a on the ship.
a) mutiny b) rebellion c) riot d) strike
9. The cargo in the hold of the ship many times in the storm.
a) changed b) floated c) shifted d) switched
10. The sea is too far out; we can't swim till the comes in.
a) current b) stream c) tide d) water
11. A lot of driftwood was washed up on to the
a) coast b) coastline c) seaside d) shore
12. The sea was so rough that the little boat
a) bent b) capsized c) inverted d) reversed
13. When we go fishing we always take a lot of worms for
a) attraction b) bait c) food d) trap
14. Swimming is dangerous here because of the strong across the bay.
a) current b) jet c) motion d) pressure
15. The boat just out to sea.
a) drifted b) slid c) strayed d) wandered
16. After the storm the of a small ship was thrown up on the shore.
a) breakage b) ruin c) wastage d) wreckage
17. The ship was not allowed to unload its
a) burden b) cargo c) freight d) load
18. When the ship docked at Hamburg, they found a in the hold.
a) gate-crasher b) interloper c) stowaway d) trespasser
19. She was very enthusiastic about sailing around the world and now was just to go.
a) bounding b) leaping c) jumping d) roaring
20. I with the captain to abandon the ship before it was too late.
a) appealed b) begged c) claimed d) pleaded
21. Due to the bad weather conditions, the lifeboat crew were asked to in case of emergency.
a) stand away b) stand by c) stand in d) stand up
22. He had a escape when his boat was capsized by a sudden gust of wind.
a) close b) narrow c) near d) sudden
23. The waves gently against the shore.
a) bit b) chewed c) lapped d) licked
24. We managed to grab a piece of wood that was floating nearby and we hung on for life.
a) dear b) gentle c) kind d) precious
25. The air-sea search operation is continuing, although hopes of finding survivors are
a) dimming b) dissolving c) fading d) reducing

* 319. SHIPS. Choose from among the given vocabulary those related to the indicated subject. The list also contains all the vocabulary needed to fill in the blanks in the following exercise.

(to) board	bow	bunks	cabins	captain
charts	cliffs	coast	compass	cranes
crew	cruise	deck-chairs	docks	(to) embark
fleet	freighters	galley	gang-way	harbour
hold	knots	latitude	life-jacket	lighthouses
liner	loaded	mate	moored	(to) navigate
navigator	overboard	rope	rudder	seamen
seasickness	stern	stewards	stormy	vessels
voyage	waves	warships	wreck	

1. Which of the above are kinds of ships?
2. Which of the above are parts of a ship?
3. Which of the above are things found on a ship?
4. Which of the above are people found on a ship?

* 320. SHIPS AND SEA TRAVEL. Fill in the blanks in the following passages with vocabulary connected with ships and sea travel. Should you find it too difficult for you, see the vocabulary list in the preceding exercise.

Ships and Sea Travel

When a ship goes out to sea it leaves the , or port. The speed of a ship is measured in The foremost part of the ship is the The name of the ship is often painted on the back. This part of a ship is called the A is used to steer the ship. The goods are stored in the

The man in command on board is the The first is responsible for navigation. To a ship the sailors need maps, a and other instruments. Sea-maps are called A knows where they are at sea by finding the longitude and

All the people who work on board are Together they are called the of the ship. The crew sleep in , or berths.

A holiday-trip by ship is a When passengers go on to a ship we say that they , or board the ship. When you want to leave or the ship you have to use the gang-plank, or Holidaymakers on board can sit in They sleep in Passengers are served food by the The food is prepared in the

Sometimes the can be dangerous, especially when the coast consists of steep rocks called Along the more dangerous parts of the there are usually used for warning ships at sea.

If a ship runs into rocks, it becomes a If your ship is wrecked you have to jump Then you should wear a

When it's weather the surface of the water begins to move. These movements of the water are called When the waves are very high many people suffer from

Ships are and repaired in They are loaded and unloaded by Ships which carry cargoes are called and those which are used for war purposes are A ship which is part of a commercial is called a A general term for ships and boats is After a ship has sailed into the harbour it is This is mostly done with a or cable.

XVII. Shopping

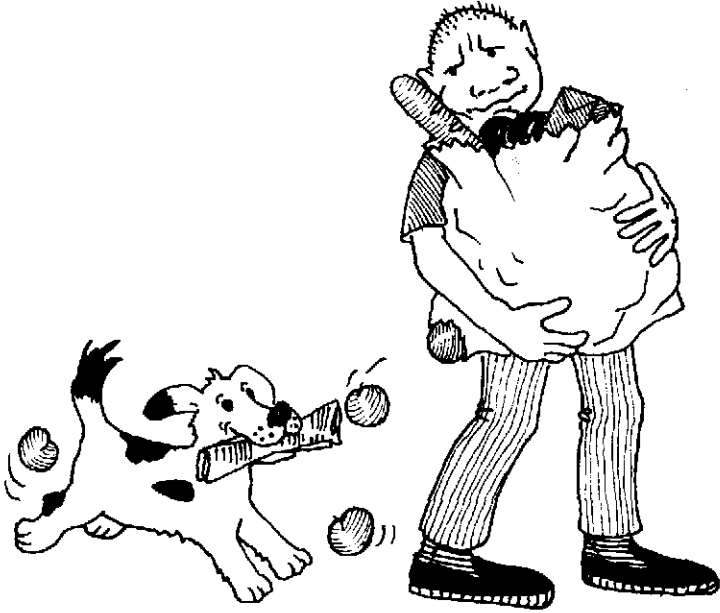

Mike: "I've just got a bottle of whisky for my mother-in-law."

John: "That's what I call a bargain!"

*

His wife was brooding all day and John couldn't stand it.

"What's wrong, sweetheart?" he asked.

"That terrible Lila Black next door has a hat exactly like mine," she replied, dabbing away an angry tear.

"And I suppose you want me to buy you a new one?"

"Well," she said, "it's a lot cheaper than moving."

321. SHOPS. *Choose the right answer.*

1. Sales staff are often told that "the is always right".
a) dealer b) employee c) customer d) stockist
2. Small shopkeepers are facing competition from supermarkets.
a) angry b) armed c) bloody d) fierce
3. A shop- is someone who steals from shops and stores.
a) carrier b) lifter c) picker d) thief
4. A modern cash register keeps a record of every
a) contract b) deal c) purchaser d) transaction
5. If you are rude to customers they are to come back.
a) impossible b) improbable c) incapable d) unlikely
6. Small shops will survive as they provide a personal
a) contact b) feel c) hold d) touch
7. Sorry to you, but have you got the key to the storeroom?
a) annoy b) bother c) disrupt d) inconvenience
8. Remember the customer is always right. You must always be
a) discreet b) harsh c) polite d) rough
9. Mr Clever was the packing department of the shop.
a) at charge of b) in charge of c) on charge from d) with charge to
10. I'm sorry, but the book is out of
a) order b) stock c) store d) supply
11. Mr Trustworthy has a very job as sales manager.
a) careful b) dutiful c) ordered d) responsible

322. KINDS OF SHOPS. *Put each of the following words and phrases into its correct place in the passage below.*

advertising	department	different	employ
families	financial	floors	goods
handles	jobs	located	merchandise
needs	occupies	optician's	personnel
price	purchases	records	roof
sales promotion	section	services	shopping
staff	store	travel agency	typical

Department Store

A department store is a which sells many kinds of goods, each in a separate Modern department stores serve the of entire People enjoy in such stores because they can make all their under one

The department store one large building, with separate departments on a number of A number provide special , such as a or

Department stores hundreds of people for different Employees buy, , and sell the The manager and his promote the sale of through and other techniques. The comptroller heads the that keeps and manages the store's affairs. The staff hire employees and other employment problems.

*** 323. SHOPS.** *Choose the right answer.*

1. The shop assistant her shoulders indifferently.
a) flexed b) raised c) shrugged d) twitched
2. Under the existing laws, all shops selling alcoholic liquor must be
a) authorised b) legalised c) licensed d) sanctioned
3. Complaints about goods should be made to the seller, not the
a) author b) creator c) shopkeeper d) wholesaler
4. Two hundred and fifty shops sell their products, but they want to increase the number of for their goods to a thousand.
a) doors b) markets c) openings d) outlets
5. The notice says there is no admission except for personnel.
a) approved b) authorised c) lawful d) legitimate
6. If you have any concerning this product please call us.
a) investigations b) queries c) requests d) wishes

324. KINDS OF SHOPS. *Match the kinds of places where you can buy things with their definitions.*

- | | |
|----------------------|--|
| 1. bazaar | a. a large shop divided into smaller parts, in each of which different types of goods are sold |
| 2. mobile shop | b. a large shop selling mainly food where one serves oneself |
| 3. boutique | c. a large shop |
| 4. department store | d. a table or small open-fronted shop in a public place |
| 5. kiosk | e. shop for the sale of cheap goods of great variety |
| 6. market | f. a part of a town limited to shopping; often without cars |
| 7. shopping arcade | g. a covered moveable shop |
| 8. shopping centre | h. a small open hut, such as one used for selling newspapers |
| 9. shopping precinct | i. a small shop selling fashionable clothes |
| 10. stall | j. a group of shops of different kinds, planned and built as a whole |
| 11. store | k. a covered passage with a row of shops on either side |
| 12. supermarket | l. open place where people meet to buy and sell goods, especially food |

325. KINDS OF SHOPS. *In which shops would you buy the following items?*

- a) apricots, radishes at the _____ 's
- b) aspirin, vitamins _____ 's
- c) bread and cakes _____ 's
- d) cigarettes, cigars _____ 's
- e) dogs, cats, hamsters _____ shop
- f) hammer, nails _____ 's
- g) mutton, veal _____ 's
- h) newspapers, magazines _____ 's
- i) pens, writing paper _____ 's
- j) roses, daffodils _____ 's
- k) salmon, herring _____ 's
- l) tea, sugar, coffee _____ 's
- m) very old furniture at an _____ shop
- n) wine, beer, vodka at an _____ (U.K.)

326. KINDS OF SHOPS. *Choose the right answer.*

1. The was thronged with crowds of shoppers on Saturday.
a) tobacconist's b) kiosk c) stall d) shopping centre
2. What do you think of this old oil lamp? I got it cheap at a sale.
a) deposit b) jumble c) refuse d) rubbish
3. The weekly market sells mainly fruit, vegetables and dairy
a) manufactures b) output c) products d) stocks
4. You can buy an iron at any shop.
a) electric b) electrical c) electrician d) electrifying
5. Her uncle has a big store.
a) clothing b) dresses c) garments d) wearing
6. The butcher's shop was an old-fashioned one; there was on the floor.
a) powder b) soil c) stones d) sawdust

*** 327. KINDS OF SHOPS.** *Decide which of the following items are sold in which shop. There are ten kinds of shops.*

- | | | | |
|------------|-----------|-------------|-----------|
| balls | bats | batteries | biscuits |
| bolts | boots | buckets | buns |
| cakes | cassettes | chops | flour |
| fruit pies | grapes | hairdryers | lamb |
| leeks | lettuces | light-bulbs | medicines |
| mince | organs | peaches | pliers |
| plugs | rackets | rakes | records |
| rolls | sandals | sausages | shampoo |
| shoes | shorts | slippers | soaps |
| vitamins | violins | | |

328. ADVERTISING. Put each of the following words and phrases in its correct place in the passage below.

advertising	announces	audiences	aware
clothes	comfortable	customs	describes
familiar	foods	improved	living
magazines	market	mass communication	messages
obtained	products	radio	seeks
selling	suggests	tastes	things

Advertising

Advertising is a form of Advertising to make people of things they need and to make them want these It tells what or services are on the , and how they can be

It new products, and new uses and features of ones. Advertising that we might enjoy more nourishing , more attractive , and more homes. In doing all these things, helps us to improve our way of It also shapes our , habits and

Advertising are carried to large by newspapers, , television, , and other means of

329. DOING THE SHOPPING. Choose the right answer.

1. Alice often her mother to the shops.
a) accompanies b) bargains c) encourages d) follows
2. There are pictures of all the new models in our sales
a) album b) catalogue c) page d) tract
3. Linda has bought some attractive paper for her Christmas presents.
a) covering b) envelope c) packing d) wrapping
4.-order shopping is popular among housewives.
a) Letter b) Package c) Post d) Mail
5. Mrs Forgetful couldn't remember what she had to buy for the weekend as she had lost her shopping
a) code b) form c) list d) record
6. I was by the wording of the advertisement.
a) misguided b) misled c) mistaken d) misunderstood
7. To get your map of Scotland just fill in the and send it with \$ 1 to the Tourist Board.
a) bill b) cheque c) coupon d) note
8. We regret that it is impossible to meet the dates for the goods you recently ordered from us.
a) arrival b) carriage c) delivery d) service

9. We to inform you that we cannot exchange articles once they have left the store.
a) regret b) respect c) sense d) sorry
10. The goods they have on offer today are certainly
a) good value b) invaluable c) priceless d) worthy
11. Everything in the supermarket is marked with a price
a) mark b) notice c) sign d) tag
12. Mrs Thrifty came to the market hoping to a cheap coat.
a) pick on b) pick out c) pick through d) pick up

330. DOING THE SHOPPING. *Choose the right answer.*

1. Do you want to on these shoes to see if they're the right size?
a) fit b) fix c) stand d) try
2. The girl in the shop was how to use a new kind of electric cooker.
a) demonstrating b) exposing c) proving d) teaching
3. It's a good area for shopping. All the shops are within easy
a) approach b) arrival c) neighbourhood d) reach
4. Buy the new of soap now on sale: it is softer than all others!
a) brand b) manufacture c) mark d) model
5. Small shops can't hope to the wide choice available in supermarkets.
a) compete b) level c) match d) overcome
6. The café at midnight, except on Saturdays.
a) closes b) ends c) finishes d) stops
7. " are welcome. Come in and look around. No obligation to buy."
a) Browsers b) Observers c) Viewers d) Watchers
8. Woolworths have a very wide of domestic goods.
a) circulation b) class c) number d) range
9. Can you to us exactly how the machine works?
a) convince b) explain c) say d) tell
10. We found some real at the sale.
a) bargains b) goods c) items d) prizes
11. I wonder if you would help me to up this present for father?
a) bind b) cover c) put d) wrap
12. The goods were displayed so well that you couldn't the temptation to buy.
a) deny b) miss c) resist d) win
13. The price of this radio is not listed in the
a) catalogue b) directory c) guidebook d) schedule
14. Take your There are plenty of dresses.
a) best b) choice c) selection d) pick
15. In a greengrocer's shop there is a lot of if fruit and vegetables are not sold.
a) rest b) rot c) ruin d) wastage

*** 331. DOING THE SHOPPING.** *Choose the right answer.*

1. They are old customers of ours. We've been with them for many years.
a) competing b) dealing c) shopping d) treating
2. Imported coffee is one of the shop's best-selling
a) angles b) areas c) directions d) lines
3. The police decided to the department store after they had received a bomb warning.
a) abandon b) evacuate c) evict d) expel
4. The auctioneer brought down his before Mr Gambler had had time to raise his bid.
a) arm b) fist c) hammer d) price
5. Mr Gambler gave a to indicate to the auctioneer that he was still in the bidding.
a) card b) nod c) sigh d) smile
6. Mrs Bigshopper asked the shopkeeper to put the vegetables in a
a) bag b) handbag c) satchel d) suitcase
7. The assistant nervously while I made up my mind.
a) drifted b) floated c) hovered d) orbited
8. I'd like to buy the radio, but I haven't got any money on me at the moment.
Could you for me for a day or two?
a) bring it round b) lay it in c) put it on one side d) take it in
9. The big new supermarket on the outskirts of town does a trade.
a) crying b) roaring c) screaming d) shouting
10. The shopkeeper his first year's profits back into the business.
a) dug b) harvested c) ploughed d) sowed
11. Her shopping bag broke, its contents all over the pavement.
a) dispersing b) distributing c) overflowing d) scattering
12. There are consumer protection laws that affect every
a) buy b) patron c) purchase d) retailer

*** 332. DOING THE SHOPPING.** *Complete with the right word.*

1. Customers in shops don't usually use credit cards, they pay in _____.
2. I have never heard of MLASK-MLASK Coffec before. Is it a new _____ n _____ ?
3. Fish shops are usually called _____ m _____ 's.
4. The cashier at the _____ h _____ t was very slow, and there was a long q _____ waiting to pay.
5. Clothes, especially, should be _____ x _____ closely before you buy them.
6. It would also be sensible to _____ on the article before buying it.
7. Let's make a _____ l; you _____ d _____ the price by 20% and I'll buy a dozen shirts.
8. Matchboxes usually _____ n _____ about 48 matches each.
9. We went to the _____ s _____ 's to get some cough medicine.

10. When we came to the shop we found a _____ c__ on the door saying " _____ s _____ on Sundays".
11. "Can I help you, sir?" "No, thanks. I'm just _____ k _____."
12. If you have a student identity card, some shops may give you a d _____ c _____ .
13. The assistant in a shop usually serves the _____ s _____ from behind a _____ n _____ .
14. If something is too heavy for you to _____ home yourself, the shop may d _____ it.
15. You can get almost anything you want in one of those big _____ r _____ t _____ .

* 333. SALESMEN. Choose the right answer.

1. The unscrupulous salesman the old man out of his life savings.
a) deprived b) extracted c) robbed d) swindled
2. Salesmen always exaggerate, so I take what they say with a pinch of
a) caution b) flesh c) pepper d) salt
3. It is very easy for the undereducated to be by slick-talking salesmen.
a) put aside b) put up c) taken away d) taken in
4. Eventually the salesman me to buy the car.
a) convinced b) decided c) suggested d) persuaded
5. The salesman told me that reading this book would make me more intelligent, but I think I've been
a) blackmailed b) conned c) libelled d) slandered
6. I didn't take up his recommendation, as he sounded so about it.
a) half-headed b) half-hearted c) half-handed d) half-witted
7. The in television sales is causing some concern to manufacturers.
a) deficit b) deterioration c) poverty d) slump
8. Last month's trade figures were bad, but the ones are even worse.
a) current b) instant c) latter d) newer
9. The salesman talked me buying a bottle of perfume for my wife.
a) away to b) into c) onto d) up to
10. The salesman sold more umbrellas during the wet spell this summer than during the spell last year.
a) corresponding b) equalling c) matching d) relating
11. The saleswoman my attention to the intricate embroidery on the front of the blouse.
a) attracted b) drew c) led d) pulled
12. The salesman informed me that if I buy something on, then I can send it back if I am dissatisfied.
a) agreement b) approval c) consideration d) favour

334. PRICE AND VALUE. *Choose the right answer.*

1. We advise our customers to advantage of our bargain prices during the coming week.
a) get b) have c) make d) take
2. To their fiftieth anniversary the store held a one-week sale.
a) mark b) paint c) sign d) write
3. Prices are very these days.
a) big b) expensive c) high d) increased
4. It is always a good idea to a bill before paying it.
a) add b) calculate c) control d) check
5. The standard of our furniture is excellent, but even so, we charge only prices.
a) just b) moderate c) slight d) small
6. If you want to return the suit, you must bring the with you as proof of purchase.
a) note b) recipe c) receipt d) prescription
7. These figures will give you a estimate of the cost of the goods.
a) rough b) scant c) short d) superficial
8. "Fantastic sale. Everything must be sold of the price!"
a) despite b) in vain c) regardless d) without
9. your change before leaving the shop!
a) Control b) Examine c) Judge d) Test
10. I can't \$70 for one book! Haven't you got a cheaper edition?
a) afford b) allow c) dispose d) provide
11. Everything is so expensive these days, it's hardly to save a penny.
a) doubtful b) likely c) possible d) probable
12. where you go, prices are higher than they were last year.
a) Doesn't matter b) In any case c) No importance d) No matter
13. I don't know the price, but it costs about \$25.
a) accurate b) exact c) proper d) true
14. Everything in the sale has been to half price.
a) decreased b) diminished c) lowered d) reduced
15. It's difficult to pay one's bills when prices keep
a) gaining b) growing c) raising d) rising
16. As far as for money is concerned, our product is unbeatable.
a) advantage b) cost c) value d) worth
17. The price of food keeps up.
a) getting b) going c) rising d) setting
18. This shop only \$1 for a loaf of bread.
a) charges b) costs c) sells d) values
19. The coat was going for a , reduced from \$100 to \$20.
a) flower b) laugh c) smile d) song
20. We have had to raise our prices because of the increase in the cost of materials.
a) crude b) natural c) original d) raw

335. DOING THE SHOPPING. Complete with the right word.

1. An ironmonger's is also known as a _____ d _____ store.
2. Articles _____ r _____ in sales are often found to be sub-standard when you get them home.
3. This jacket was a particularly good _____ because I bought it in the summer _____, when it was half-price.
4. She was given a very valuable ring. I think it must be _____ t _____ at least \$1,000.
5. At a supermarket on Saturdays you often have to queue for ages at the ch _____ - o _____.
6. Someone who owns a small shop and who serves the customers there is a _____ p _____.
7. If the TV set goes wrong within a year, remember it will still be under _____ r _____.
8. In case you want to exchange something, remember to keep your _____ c _____.
9. You can spread the payment over 12 or 24 months by buying this washing machine on h _____ c _____.
10. We offer a _____ c _____ of 10% on purchases over \$150.
11. Fine foods from all over the world can be bought in a d _____.
12. If you want a _____ p _____ to reserve an article for you until a later date, he'll probably ask you to pay a _____ p _____.
13. The store's policy is to prosecute anyone who is caught s _____.
14. Secondhand furniture can be bought cheaply at an a _____ c _____ sale.
15. You will find that this shop has a w _____ choice of shoes.

*** 336. PRICE AND VALUE.** Choose the right answer.

1. They were paying for their television set by
a) credits b) deposits c) facilities d) instalments
2. It's no good asking me to calculate the cost. I'm hopeless at
a) characters b) figures c) prizes d) shapes
3. There is a sale next week with in all departments.
a) basements b) decreases c) reductions d) redundancies
4. The price of fresh fruit according to the season.
a) alternates b) fluctuates c) oscillates d) waves
5. Mr Rich managed to get the ancient sculpture by putting in a high at the auction.
a) bet b) bid c) stack d) tender
6. Buyers and sellers were over prices.
a) hacking b) haggling c) heckling d) hugging
7. Most prices were in the final days of the clearance sale.
a) declined b) diminished c) slashed d) taken down
8. The trader asked a high price, but I managed to beat him
a) back b) down c) off d) up

9. To order the goods, send your name, address and to the following PO bo
 a) cost b) postal order c) receipt d) settlement
10. As a result of increased trading, the company made a of nearly half a million dollars.
 a) bonus b) gain c) profit d) revenue

337. CASH OR CHEQUE. *Choose the right answer.*

1. When I paid for my groceries, the shop assistant gave me the wrong
 a) change b) exchange c) return d) sum
2. Who do I make the cheque to?
 a) in b) on c) out d) up
3. Naturally you can payment until you are satisfied that the work has been properly carried out.
 a) hold in b) hold up c) withdraw d) withhold
4. I can buy this PC if you'll a cheque.
 a) agree b) give c) receive d) take
5. Mr Particular being given a receipt for the bill he had paid.
 a) asked to b) demanded c) insisted on d) required
6. Will you pay cash for the goods or would you like them to your account?
 a) charged b) indebted c) priced d) receipted
7. She said she would pay for the clothes by credit
 a) bank b) card c) cheque d) note
8. Don't shop at SNOB's supermarket; you have to pay through the there.
 a) account b) bank c) mouth d) nose
9. We will accept your cheque, although it is not our normal
 a) intention b) occasion c) practice d) state
10. All the from the jumble sale will be given to charity.
 a) expenses b) income c) proceeds d) rewards

338. COMPLAINTS. *Choose the right answer.*

1. I'm afraid we haven't got what you want in at the moment, but we can order it for you.
 a) reserve b) sale c) shop d) stock
2. If you do not have ready cash, you can always buy the goods on purchase.
 a) borrow b) hire c) lend d) rent
3. To remove order form please tear along the line.
 a) dotted b) marked c) pointed d) spotted
4. Every word processor we sell comes with a year's
 a) assurance b) guarantee c) safeguard d) security

5. Buying in bulk one to make substantial savings.
a) empowers b) enables c) facilitates d) means
6. I took the shoes back to the shop, but the manager to change them.
a) denied b) disliked c) disagreed d) refused
7. I you that goods will be delivered next week.
a) assure b) confirm c) insist d) undertake
8. Although he was under no the shopkeeper replaced the defective battery free of charge.
a) authority b) guarantee c) obligation d) urgency
9. If you are not entirely with our product, we will refund your money in full.
a) agreeable b) convinced c) favourable d) satisfied
10. As we can wait no longer for the delivery of our order, we will have to it.
a) cancel b) delay c) postpone d) refuse
11. We are your request and will reply shortly.
a) considering b) noticing c) searching d) thinking
12. I'd like to this TV I bought from you last week. There seems to be something wrong with it.
a) alter b) change c) remove d) turn over
13. I'll have to take the toy back to the shop to exchange it because the mechanism is
a) blame b) defect c) false d) faulty
14. This set is the only one of its kind, so none of the cups can be
a) copied b) exchanged c) replaced d) substituted
15. If develops in your new TV within six months of purchase, you will be
a) a fault b) a mistake c) an error d) damage
. to a replacement.
a) allowed b) entitled c) guaranteed d) permitted

339. GOODS. *Choose the right answer.*

1. That supermarket carries a wide of goods.
a) line b) load c) range d) series
2. The advantage of this new plastic covering is that it will to fit any size of object.
a) change b) expand c) extend d) stretch
3. The expert said that the stone was not a jewel and was therefore
a) invaluable b) priceless c) profitless d) valueless
4. What of soap do you buy?
a) class b) make c) mark d) style
5. The of strawberries on the market is due to a late frost.
a) drought b) exception c) rarity d) scarcity

6. This carpet was made that is why it is so expensive.
a) by hand b) by hands c) by the hand d) with hands
7. This cloth is of good but it is not expensive.
a) character b) condition c) quality d) virtue
8. We made a wooden toy with an empty cotton and some glue.
a) ball b) reel c) roll d) spool
9. The butcher cut some pork, it up and handed it to me.
a) closed b) strung c) wound d) wrapped
10. There is a of grain in our country at the moment.
a) need b) requirement c) shortage d) want
11. That is where they whisky.
a) brew b) cook c) distill d) stew
12. That shop sells clothes, but they are well-made.
a) ancient b) antique c) elderly d) old-fashioned
13. We've run sugar. Ask Mrs Helpful to lend us some.
a) away with b) down c) off d) out of
14. Grain and coffee are major trading
a) articles b) commodities c) materials d) stocks
15. When I pointed out that there was a small in one of the glasses, the shop gave me a 15% reduction on the set.
a) blot b) crack c) smear d) smudge
16. That old vase will an attractive lamp-holder.
a) assemble b) compose c) form d) make
17. This fantastic new gadget has been selling like cakes.
a) birthday b) cream c) hot d) wedding
18. Mr Critical assured me that he never bought that were advertised on TV.
a) article b) productions c) projects d) products
19. I must take this watch to be repaired; it over ten minutes a day.
a) accelerates b) gains c) increases d) speeds
20. New products are announced to the public
a) by mail order b) by productions c) by propaganda d) on posters

340. CONTAINERS. Match the pictures with the right name for the container.

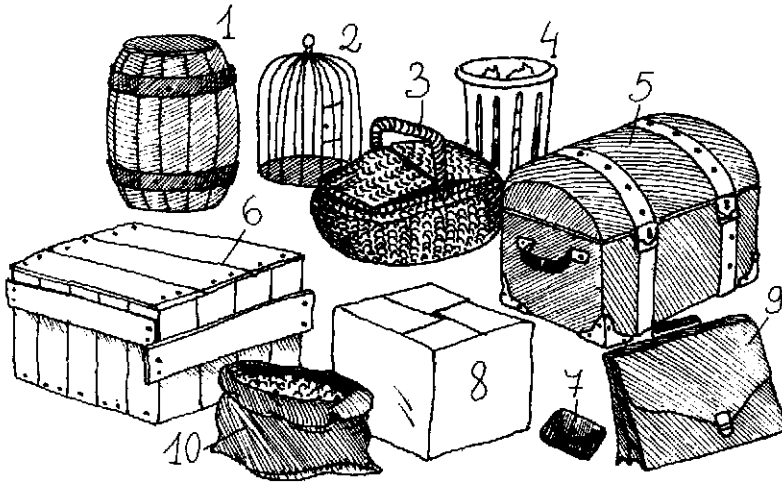

- | | | | |
|------------|------------|---------------|-----------|
| ... barrel | ... basket | ... briefcase | ... cage |
| ... carton | ... crate | ... dustbin | ... purse |
| ... sack | ... trunk | | |

341. CONTAINERS. Match each container with its contents.

- | | |
|------------------|--------------------------------------|
| 1. barrel | a. bank notes, tickets, etc. |
| 2. basket | b. beer |
| 3. bin | c. boiling water |
| 4. box | d. business papers |
| 5. briefcase | e. cash, secret documents, jewellery |
| 6. envelope | f. clothes for holidays |
| 7. thermos flask | g. clothes for longer holidays |
| 8. jug | h. coins |
| 9. kettle | i. flowers |
| 10. purse | j. hot coffee, cold drinks |
| 11. safe | k. letter |
| 12. satchel | l. matches |
| 13. suitcase | m. school books |
| 14. tank | n. shopping |
| 15. trunk | o. suits, jackets, clothes |
| 16. vase | p. waste paper or bread |
| 17. wallet | q. water, petrol |
| 18. wardrobe | r. water, milk |

342. NOUNS OF QUANTITY. Fill the blanks with the nouns of quantity given below.

bunch bundle deck fleet flight heap
 lump pile pint plate row string

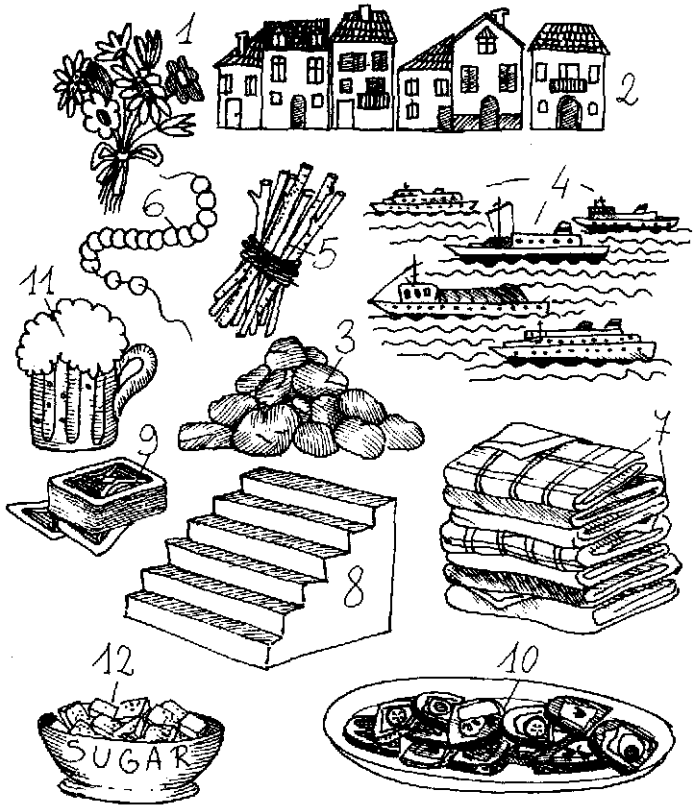

- 1) of flowers 2) of houses 3) of stones 4) of ships
 5) of sticks 6) of beads 7) of blankets 8) of stairs
 9) of playing cards 10) of sandwiches 11) of beer 12) of sugar

343. QUANTITIES. Insert the names of units in which we usually buy the following items. Do not use "pound" or "packet" or "piece" or "slice". The number of letters is given.

1. a _____ of toothpaste
2. a _____ of trousers
3. a _____ of milk
4. a _____ of beer
5. a _____ of marmalade
6. a _____ of bread
7. a _____ of film
8. a _____ of string

9. a _____ of knives
10. a _____ of chocolates
11. a _____ of playing cards
12. a _____ of flowers
13. a _____ of drawers
14. a _____ of fish
15. a _____ of soap

344. QUANTITIES. *Choose the right answer.*

1. You very rarely find peas in nowadays, they are usually sold in packets or tins.
a) boxes b) pods c) skins d) shells
2. He took a of cigarettes out of his pocket.
a) block b) dozen c) packet d) piece
3. The table was described in the catalogue as a beautiful of furniture.
a) manufacture b) object c) piece d) think
4. When you go to the shops, bring me
a) a fruit tin b) a fruits tin c) a tin of fruit d) a tin of fruits
5. If you wait a moment, there'll be another of loaves, fresh from the oven.
a) batch b) bunch c) bundle d) collection
6. The twelve bottles of whisky were delivered in a sturdy
a) canteen b) carafe c) carton d) cartoon
7. The lorry was carrying a of potatoes.
a) charge b) load c) lump d) pile
8. I want to buy a of soup.
a) box b) helping c) packet d) piece
9. She has gone to the baker's to buy a of bread.
a) bar b) bit c) loaf d) pound
10. I'd like a packet of razor , please.
a) blades b) cuts c) leaves d) metals

345. QUANTITIES. *Insert the names of units in which we usually buy the following items. Do not use "pound" or "packet" or "piece" or "slice". Each dash represents one letter.*

1. a huge _____ of glass for a broken window
2. a _____ of wallpaper
3. three ras _____ s of bacon
4. some coffee _____ to grind
5. Shakespeare's complete works in one big _____

346. CROSSWORD PUZZLE.

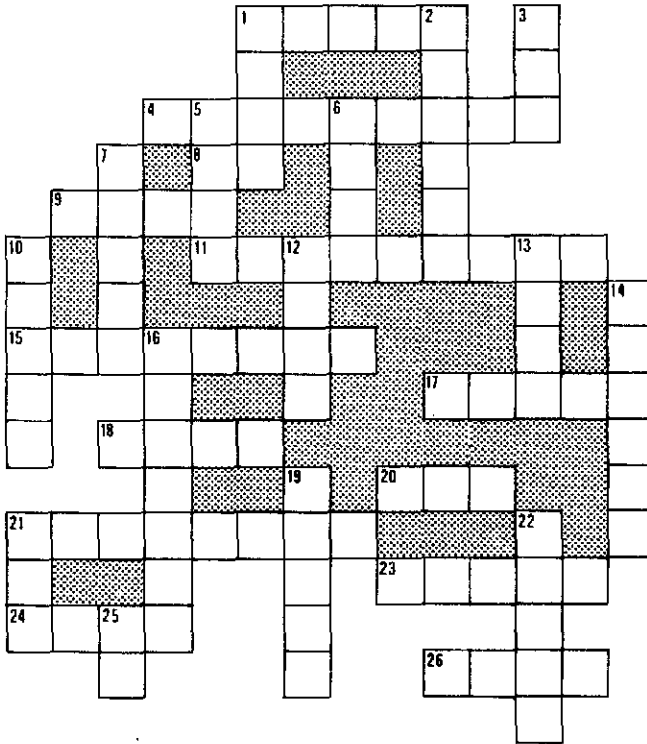

ACROSS:

1. not banknotes (5)
4. serves in shops (9)
8. the greengrocer's (2)
9. a of bread (4)
11. not cheap (9)
15. amount of money which may be taken off the full price (8)
17. line of people in a shop (5)
18. a of toothpaste (4)
20. a of fish (British English) (3)
21. one who buys (8)
23. place where you do your shopping (5)
24. not far (4)
26. used for adornment or making wedding gowns (4)

DOWN:

1. price (4)
2. used for weighing (6)
3. a new of false teeth (3)
5. burglar-proof box in which money is kept (4)
6. offering goods at lower prices for a limited period (4)
7. merchandise (5)

10. request to supply goods (5)
12. a of beer (4)
13. for holding cut flowers (4)
14. written order to a bank to pay money (6)
16. flat surface on which goods are shown; customers served (7)
19. to measure how heavy something is (5)
21. a of peaches in light syrup (American English) (3)
22. sum of money for which something is bought or sold (5)
25. advertisement (2)

XVIII. Socializing and Pastimes

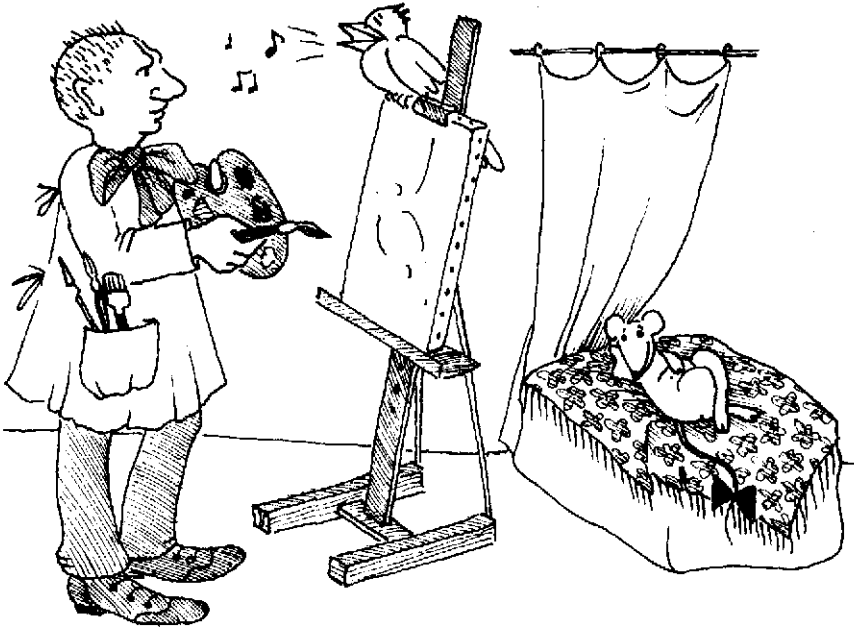

A lady gave a reception for a group of college students. Among those present was a foreign student who had studied a book of etiquette. Handed a cup of tea, he said:

“Thank you, sir or madam, as the case may be.”

*

“My uncle never smokes, drinks, goes to the movies or night clubs. He never swears or plays cards and he never married. He’s going to celebrate his ninety-eighth birthday next week.”

“How?”

* 347. **SOCIALIZING.** Complete the sentences with the right form of the following words.
Sometimes there is more than one possible answer.

TO AMUSE TO ENJOY TO ENTERTAIN TO SOCIALIZE

1. Peter ed himself by throwing chestnuts into the fire.
2. I wondered what could have led me to so ludicrous a thought.
3. We had a beautiful house where we ed many famous people.
4. Dancing is something that I really doing.
5. As he was rather an introvert he found it difficult to
6. During my school years I was happy to with the biology students.
7. We had to keep thinking of things to her.
8. We ed the guests with a detailed description of the trip we had ed so enormously.

348. **SOCIALIZING.** Choose the right answer.

1. Your annual to the Book Club is now due.
a) contribution b) investment c) offering d) subscription
2. I'm going to spend a few days with some of mine who live in England.
a) companies b) familiars c) neighbours d) relatives
3. People under 18 years old are not to join this club.
a) admissible b) advisable c) desirable d) eligible
4. The party was awful. It was a complete
a) failure b) prospect c) success d) treat
5. I had to the invitation as I had a previous engagement.
a) abandon b) deny c) leave d) refuse
6. We have been able to use these splendid premises this morning by kind of the Director of the University Museum.
a) allowance b) courtesy c) permission d) thanks
7. He is the of the committee that arranges the programme.
a) chairman b) director c) leader d) president
8. She arranged the party to help put the strangers at
a) comfort b) delight c) ease d) pleasure
9. I had to be up early the next morning, so I myself and left the party.
a) apologized b) excused c) refused d) thanked
10. I'd like to a warm welcome to our visitors from abroad.
a) extend b) prolong c) search out d) stretch
11. Please ^{apologise} accept my for not coming to the meeting last week.
a) apologies b) excuses c) forgiveness d) pardon
12. . . . I would like to say how pleased I am to be here.
a) Earliest b) First c) Foremost d) Primarily

* 349. **SOCIALIZING.** Choose the right answer.

1. The party was already in full when they arrived.
a) career b) cry c) flood d) swing
2. The from last week's charity ball were far more than expected.
a) acquisitions b) earnings c) proceeds d) winnings
3. I am never free on Sunday evenings as I have a arrangement to meet my school friends.
a) long-lasting b) long-lived c) long-range d) long-standing
4. One can become a member of this club only on paying the fee.
a) enrolled b) legitimate c) requisite d) regulated
5. The organization is mainly staffed by workers.
a) free b) unsolicited c) voluntary d) willing
6. Our new neighbour's party went on into the hours.
a) bright b) early c) first d) small
7. All , there must have been at least a hundred people at the party.
a) found b) meant c) said d) told
8. He made a very excuse for not attending the meeting.
a) faint b) feeble c) fragile d) frail
9. He has a wide circle of friends and so leads a fairly social life.
a) fast b) furious c) hectic d) speedy
10. of all of us, I would like to thank you for accepting our invitation.
a) In person b) Instead c) On account d) On behalf

* 350. **WAYS OF WRITING.** Match the following verbs describing various ways of writing with their definitions on the right.

- | | |
|-------------------|---|
| 1. to annotate | a) to put something into a written form, e.g. a speech |
| 2. to autograph | b) to write carelessly or in a hurry so that it is hard to read |
| 3. to compose | c) to write using a typewriter |
| 4. to inscribe | d) to write in an irregular, awkward, or unskillful way, usually covering more space than necessary |
| 5. to jot | e) to add short notes to explain certain parts of a book, etc. |
| 6. to note | f) to write using square, unjoined letters; also used in books |
| 7. to print | g) to sign with one's own name to show that one is the writer of a book, etc. |
| 8. to scrawl | h) to write a name in a book, especially when giving it as a present |
| 9. to scribble | i) to write rough notes quickly, without preparation |
| 10. to sign | j) to write in a short form |
| 11. to spell | k) to write one's name specially, on letters, official forms, etc. |
| 12. to transcribe | l) to form words correctly from letters |
| 13. to type | m) to write music, poetry, etc. |

* **351. WAYS OF WRITING.** *Fill in the following sentences using the verbs describing various ways of writing.*

1. He some notes for the talk he had just been asked to give after the dinner.
2. There was a name on the wall.
3. Will you your new book for me, please?
4. My name is B-R-O-W-N not B-R-A-W-N.
5. Please your address clearly in block capitals.
6. His name was on a metal plate beside the door.

352. BOOKS. *Match each kind of book with what you would normally expect to find in it.*

- | | |
|------------------|---|
| 1. atlas | a) basic coursebook at school or university |
| 2. autobiography | b) information about subjects in alphabetical order |
| 3. dictionary | c) lists of words grouped according to their similarity in meaning |
| 4. directory | d) maps |
| 5. encyclopedia | e) a list of names of places printed at the end of an atlas |
| 6. gazetteer | f) a list of important, famous people and brief details of their lives |
| 7. guidebook | g) meanings of words |
| 8. manual | h) tourist information about a country |
| 9. textbook | i) instructions on how to use or repair a machine |
| 10. thesaurus | j) a list of names, addresses and telephone numbers in alphabetical order |
| 11. Who's Who | k) the story of one's own life written by oneself |

353. BOOKS. *Choose the right answer.*

1. I don't like reading history or biographies; I prefer myself.
a) description b) fiction c) invention d) narration
2. That book has been out of for a long time.
a) copy b) press c) print d) publication
3. You have to pay a if you do not return your library books on time.
a) fee b) fine c) penalty d) tax
4. Most of the poet's earlier work was published under a
a) misnomer b) namesake c) nickname d) pseudonym
5. His new book received good from the critics.
a) comprehension b) flavours c) reviews d) understanding
6. He bought the book for half price because its was torn.
a) coat b) coating c) cover d) skin
7. I have just read a lovely about a man who devoted his life to monkeys.
a) fiction b) history c) production d) story
8. The first of a book can sometimes be very valuable.
a) copy b) edition c) title d) type

9. Ms Original had a little in with other authors of her generation.
a) common b) everyday c) normal d) ordinary
10. That author has written a fictional of his wartime experiences.
a) account b) novel c) story d) tale
11. This is a good of his delight in unusual words and phrases.
a) case b) example c) expression d) passage
12. I can't read this book without my glasses. The is too small.
a) handwriting b) letter c) print d) typewriter
13. Ask the publishers to send you their latest of English text-books.
a) booklet b) catalogue c) index d) prospectus
14. I'm reading a book about of Henry VIII.
a) the existence b) the life c) the living d) the road
15. The printing of the book has been held up by the paper
a) deficit b) lack c) scarce d) shortage
16. The essayist, John Cardinal Newman, was one of the most distinguished men of of his time.
a) books b) letters c) publications d) writings
17. In your criticism of this work, I think you have done less than to the originality of his style.
a) appreciation b) approval c) justice d) praise
18. Because Shakespeare mainly wrote plays, he is usually regarded as
a) an author b) a dramatist c) a novelist d) a writer
19. He knows most of Wordsworth's poems by
a) head b) heart c) memory d) mind

*** 354. BOOKS.** *Divide the following words into four groups.*

1. *Kinds of printed matter.*
2. *Handwritten matter*
3. *Reference books*
4. *Kinds of poems*

Some words may belong to more than one group.

atlas	ballad	brochure	catalogue
couplet	dictionary	directory	draft
eclog	encyclopedia	hardback	leaflet
lexicon	limerick	lyric	nursery rhyme
manuscript	ode	pamphlet	paperback
scroll	sonnet	thesaurus	

*** 355. BOOKS.** Match the descriptions with the names of parts of a book.

- | | |
|--------------------|--|
| 1. appendix | a) the cover of a book |
| 2. bibliography | b) a short description by the publisher of the contents of a book, printed on its paper cover |
| 3. binding | c) an introduction to a book |
| 4. blurb | d) a preface, especially in which someone who knows the writer and his work says something about them |
| 5. chapter | e) an introduction to a play, long poem |
| 6. contents | f) one of the main divisions of a book, usually having a number or a title |
| 7. cross-reference | g) one part of a book, which is read on the radio in regular parts until the story is completed |
| 8. epilogue | h) a list of what is contained in the book |
| 9. foreword | i) the end of a book, giving additional information |
| 10. index | j) a list of all the writings used in the preparation of a book |
| 11. instalment | k) a list at the back of a book giving, in alphabetical order, names, subjects, etc. mentioned in it and the pages where they can be found |
| 12. preface | l) a note directing the reader from one place in a book to another place in the same book |
| 13. prologue | m) a part of a story, play, etc. that is added after the end, usually a kind of summing-up |

*** 356. BOOKS.** Complete with the right name of the part of a book.

1. This old book is in leather.
2. Look at the list of the in the book and find on which the first starts.
3. He wrote a to his book, explaining why he had written it.
4. He listened to the fourth of the novel on the radio last night.
5. This is a of all the works published by Oxford University Press in the past fifty years.
6. In this book are shown with an asterisk (*).

*** 357. BOOKS.** Choose the right answer.

1. This book is too , I don't understand it.
a) blank b) dark c) obscure d) secret
2. In Mr Critical's opinion, Mary's reputation as a writer is very
a) overestimated b) overlooked c) overrated d) overstated
3. The bookshop said they did not have the drama just then, but that it was on
a) arrival b) delivery c) order d) purpose
4. Don't read all the book. Just the first few pages quickly.
a) dissect b) glance through c) look round d) see into

5. A poet has to be extremely to the music of words.
a) alert b) sensible c) sensitive d) sentimental
6. Shakespeare's plays fall into three categories: tragedies, comedies and histories.
a) ample b) broad c) expansive d) thick
7. The peace of the public library was by the sound of a transistor radio.
a) demolished b) fractured c) smashed d) shattered
8. If he didn't have the royalties from his book to his tiny income, he simply wouldn't survive.
a) amplify b) contribute c) expand d) supplement
9. This young author has already received the sort of that many who are older and wiser have had to strive a lifetime for.
a) attentiveness b) note c) notoriety d) recognition
10. The story had a macabre to it.
a) clang b) noise c) ring d) tick
11. He was a learned man, and few travellers have written with so much
a) acquisition b) apprehension c) cultivation d) erudition
12. His reputation has been greatly by the success of his new book.
a) enhanced b) enlarged c) expanded d) heightened
13. Some writers take a lightweight typewriter with them wherever they go.
a) bearable b) carrying c) portable d) weighing
14. He says he would write an English course book if he could find a(n) to deal with the less interesting parts.
a) ally b) collaborator c) confederate d) partner
15. I was in no way prepared for the of criticism my play received.
a) assault b) offensive c) onset d) onslaught

358. NEWSPAPERS AND MAGAZINES. *Choose the right answer.*

1. I don't think this newspaper cartoon is very funny, but I like the under it.
a) caption b) label c) message d) text
2. When you go out, will you get me of "Newsweek" ?
a) a copy b) an edition c) a paper d) a publication
3. A from the local newspaper asked for details of the accident.
a) broadcaster b) newsagent c) reporter d) salesman
4. The press couldn't speak to the Ministry employees: they had to wait for a statement from the Government
a) messenger b) reporter c) speaker d) spokesman
5. Although there is no official censorship in our country, the press is still the laws of the land.
a) accountable to b) controlled by c) restrained by d) subject to
6. I read a newspaper every day to keep with current affairs.
a) contemporary b) modern c) present-day d) up-to-date

7. There is a very interesting about cancer in the paper.
a) article b) documentary c) news d) programme
8. A newspaper normally makes the final decision about the paper's contents.
a) editor b) journalist c) reporter d) publisher
9. Dear Sirs, I am writing in response to your for a sales clerk in yesterday's "Business Man".
a) advertisement b) announcement c) propaganda d) publicity
10. Our newspaper increased its by eighty thousand copies.
a) amount b) circulation c) numbers d) quantity
11. Could I have a copy of the issue of the "National Geographic", please?
a) actual b) circulating c) latest d) recent
12. He took out a(n) to "The Times".
a) conscription b) inscription c) prescription d) subscription
13. You must look in the section of the newspaper to find what films are showing.
a) diversion b) entertainment c) recreation d) variety
14. Every morning I do the crossword in the newspaper.
a) problem b) puzzle c) question d) test
15. Many newspapers are holding lotteries to sales.
a) advertise b) progress c) promote d) publicise

* 359. NEWSPAPERS AND MAGAZINES. Choose the right answer.

1. Jimmy is the critic of the local newspaper.
a) lettered b) literal c) literary d) literate
2. There are five mistakes in this picture. Can you find them?
a) deliberate b) instrumental c) intensive d) presumptuous
3. What was the of that article on Romania? I haven't had time to read it.
a) digest b) draft c) gist d) synopsis
4. The information was to the press before it was officially announced.
a) dripped b) dropped c) leaked d) seeped
5. Many of the new newspapers have a pronounced right-wing
a) balance b) bearing c) bias d) setting
6. An advertising should be short, striking and easily remembered.
a) caption b) epigram c) motto d) slogan
7. He the newspaper in the hope of finding news of his daughter.
a) glanced b) glimpsed c) observed d) scanned
8. He was angry because of the many of his privacy by journalists.
a) infiltrations b) interferences c) interruptions d) invasions
9. She used her weekly column in the local newspaper as a for her political views.
a) means b) passage c) vehicle d) vessel
10. This paper intends to fearlessly all forms of corruption in public life.
a) expose b) present c) uncover d) unveil

360. NEWSPAPERS AND MAGAZINES. Read the newspaper contents list. Which pages would you look at if you wanted to read about the following:

1. articles for sale
2. clothes
3. the editor's comments on the news
4. films being shown locally
5. houses for sale
6. news from abroad
7. people who have died recently
8. recently published books
9. second-hand cars
10. duties performed by the Queen yesterday

INDEX

Appointments	37—42
Arts, Reviews	20
Business	25—33
Classified Ads	48—66
Court and Social	18
Editorial	1
Entertainment	22
Fashion	16
Home News	1, 3, 7,
House Hunter's Guide	46—7
Obituaries	19
Overseas News	10, 11

*** 361. PARTS OF A THEATRE.** Indicate in the picture below the listed parts of a theatre. Write the correct numbers next to the name of each part.

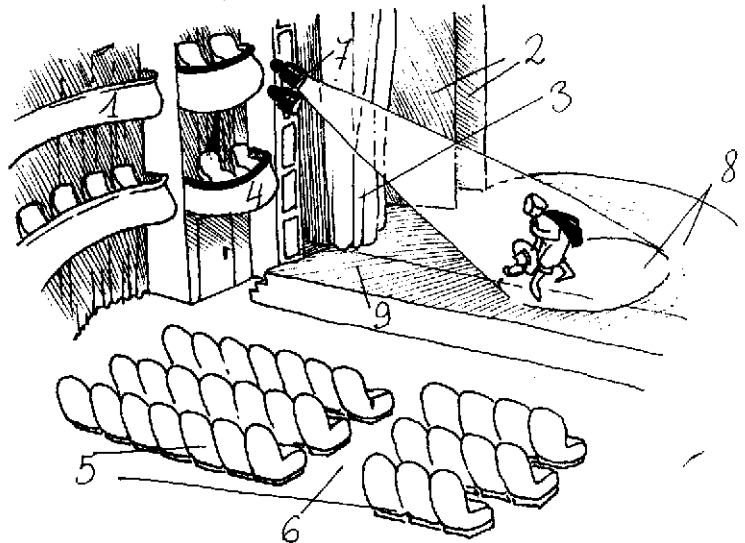

- ... aisle
- ... box
- ... curtain
- ... footlights
- ... gallery
- ... spotlight
- ... stage
- ... stalls
- ... wings

362. PARTS OF A THEATRE. *Choose the right answer.*

1. After the performance, please come and meet some of the cast.
a) backstage b) downstairs c) inside d) outside
2. The actors walked on to the and the play began.
a) landing b) pavement c) platform d) stage
3. I had to stand in a four hours to get the tickets for this performance.
a) file b) procession c) queue d) tail
4. After the interval, the change of brought a gasp of surprise from the audience.
a) panorama b) scenery c) view d) vista
5. All the theatre seats had been sold, so there was standing only.
a) area b) place c) room d) space
6. The box office is open for ticket sales.
a) a day b) daily c) daytime d) in day
7. Your seat is number A13. That's in the front on the right.
a) line b) rank c) row d) seat
8. We agreed to meet in the of the theatre, near the cloakroom.
a) anteroom b) foyer c) hall d) porch
9. My brother, who is fond of acting, has joined an dramatic society.
a) amateur b) impersonal c) unprofessional d) untrained
10. Are there any seats left for this week's of „Tosca“?
a) acting b) drama c) opera d) performance
11. All the seats in the theatre were weeks before the first performance.
a) engaged b) occupied c) sold out d) taken
12. The management the right to refuse admission.
a) holds b) keeps c) preserves d) reserves

363. PARTS OF A THEATRE. *Match each part of a theatre on the left with its definition on the right.*

- | | |
|----------------------|---|
| 1. AISLE | a) ticket office |
| 2. BACKSTAGE | b) the hall at the entrance to a theatre |
| 3. BALCONY | c) the way between the seats in a theatre |
| 4. BOX | d) a line of seats for people side by side |
| 5. BOX OFFICE | e) the seats on the ground floor |
| 6. CIRCLE | f) sunken area in front of the stage where an orchestra may play |
| 7. FOYER | g) the part of a theatre where people can sit above the ground level |
| 8. GALLERY (or GODS) | |
| 9. ORCHESTRA PIT | h) one of the upper parts in a theatre, in which the seats are arranged in part of a circle around the building |
| 10. ROW | |
| 11. STAGE | i) the highest upper floor in a theatre |
| 12. STALLS | j) a small room in a theatre, on either side, from which a small group of people can watch the play |
| | k) the raised area in a theatre where actors perform |
| | l) the area out of sight of the audience |

**** 364. PARTS OF A STAGE.** Match each part of a stage on the left with its definition on the right.

- | | |
|------------------|--|
| 1. BACKCLOTH | a) something built and provided with furniture, scenery, etc, to represent the scene of the action of a play |
| 2. BACKSTAGE | b) a painted cloth hung across the back of the stage |
| 3. CURTAIN | c) at or towards the back of the stage |
| 4. DOWNSTAGE | d) at or towards the front of the stage |
| 5. DRESSING ROOM | e) behind the stage, especially in the dressing rooms of the actors |
| 6. FOOTLIGHTS | f) a room behind the stage where an actor can get ready for his performance |
| 7. SCENERY | g) the sides of a stage, where an actor is hidden from view |
| 8. SET | h) a sheet of heavy material, drawn or lowered across the front of the stage |
| 9. SPOTLIGHT | i) a row of lights along the front of the floor of a stage |
| 10. TRAPDOOR | j) a lamp with a movable narrow beam |
| 11. UPSTAGE | k) the set of painted backgrounds and other objects used on a stage |
| 12. WINGS | l) a small door, covering an opening in the floor on a stage |

365. ACTORS. Choose the correct answer.

- He on stage for only one scene.
a) appeared b) emerged c) entered d) erupted
- He played the lead in a production of "Macbeth".
a) memorable b) memorised c) recalled d) reminded
- Her as a tragedian took her to every part of the world.
a) fame b) glory c) renown d) status
- Halfway through the first act, the leading man forgot his
a) declamations b) lines c) parts d) speeches
- He soon made a for himself on the stage.
a) fame b) popularity c) reputation d) regard
- When he forgot his lines the whispered them from the side of the stage.
a) messenger b) prompter c) pusher d) reminder
- Public figures, such as actors, are often reluctant to talk about their lives.
a) individual b) particular c) personal d) private
- I doubt if I will be enough to play tomorrow.
a) fit b) healthy c) recovered d) sound
- Miss Best was proud to be out for special praise for her performance.
a) distinguished b) selected c) separated d) singled
- Don't shouting for ability as a dramatic actor.
a) identify b) imagine c) mislead d) mistake
- For the first night's performance the had to be called in to take the part because the leading lady was ill.
a) deputy b) reserve c) substitute d) understudy

12. The highlight of his acting career was the opportunity to play the of Hamlet.
a) characterisation b) part c) personage d) play
13. The actors have to before they appear in front of the strong lights on stage.
a) cover up b) do up c) make up d) paint up
14. He gave the best performance of his acting career in the of Othello.
a) action b) personage c) role d) theme
15. That comedian is very good at ; he can take off the President perfectly.
a) duplications b) impressions c) reproductions d) similarities

366. PEOPLE IN A PLAY. Match the people on the left with a definition on the right.

- | | |
|---------------|---|
| 1. CAST | a) the main bad character in a play |
| 2. HAM | b) a set of actors in a play |
| 3. HERO | c) a company of dancers, members of a circus |
| 4. HEROINE | d) the most important male part in a play |
| 5. STAND-IN | e) a famous actor or actress |
| 6. STAR | f) an actor who learns an important part in a play so as to be able to take the place of the actor who plays that part if necessary |
| 7. STUNT MAN | g) a person who takes the part of an actor at dangerous points in a film |
| 8. TROUPE | h) the most important female part in a play |
| 9. UNDERSTUDY | i) a person who does dangerous acts in a film so that the actor does not have to take risks |
| 10. VILLAIN | j) an actor who acts artificially, unnaturally |

367. PEOPLE IN THEATRE, CIRCUS, NIGHTCLUB. Which of the following would you expect to see:

- a) in a circus
- b) in a theatre
- c) in a nightclub

Some fit into more than one category.

audience	clown	comedian	compere	dancer
fire-eater	leading lady	midget	ringmaster	stripper
sword-swallower	tightrope walker	understudy	usher	

368. THEATRE. Choose the right answer.

1. During the dress he was relaxed, but he was very nervous on the first night.
a) performance b) production c) rehearsal d) repetition
2. The light gradually and shapes and colours grew fainter.
a) died b) disappeared c) faded d) melted

3. The local amateur dramatic group are going to a play by Wilder.
a) make up b) put on c) show up d) take up
4. The actors were very pleased that there was such a large for the first night of the new play.
a) assembly b) audience c) congregation d) meeting
5. The actor had six curtain after his marvellous performance.
a) calls b) demands c) requests d) shouts
6. The National Theatre receives a large from the Government every year.
a) donation b) gift c) subsidy d) support
7. The audience out laughing when the actor fell over.
a) broke b) burst c) called d) shouted
8. During the we had a drink and discussed the first act of the play.
a) break b) interruption c) interval d) pause
9. He felt nervous on the first night because he had never performed in before.
a) audience b) common c) company d) public
10. "Smoking forbidden in the theatre".
a) exactly b) seriously c) strictly d) strongly
11. What is usually called "magic" is really a trick. The quickness of the hand the eye.
a) belies b) deceives c) disguises d) mistakes
12. The children gazed at the magician as he performed his tricks.
a) eagle-eyed b) hawk-eyed c) open-eyed d) wide-eyed

369. THEATRE. Fill in the defined words.

	1	___	T	
	2	___	H	_____
	3	_____	E	_____
	4	_____	A	_____
5	_____		T	
	6	_____	R	_____
	7	_____	E	___

1. part of a play (3)
2. practising a play (9)
3. people watching a play (8)
4. handclapping after the play (8)
5. author of plays (10)
6. the showing of the play (11)
7. person who shows people to their seats in a theatre (5)

370. MUSIC. Name the following instruments. Each dash represents one letter.

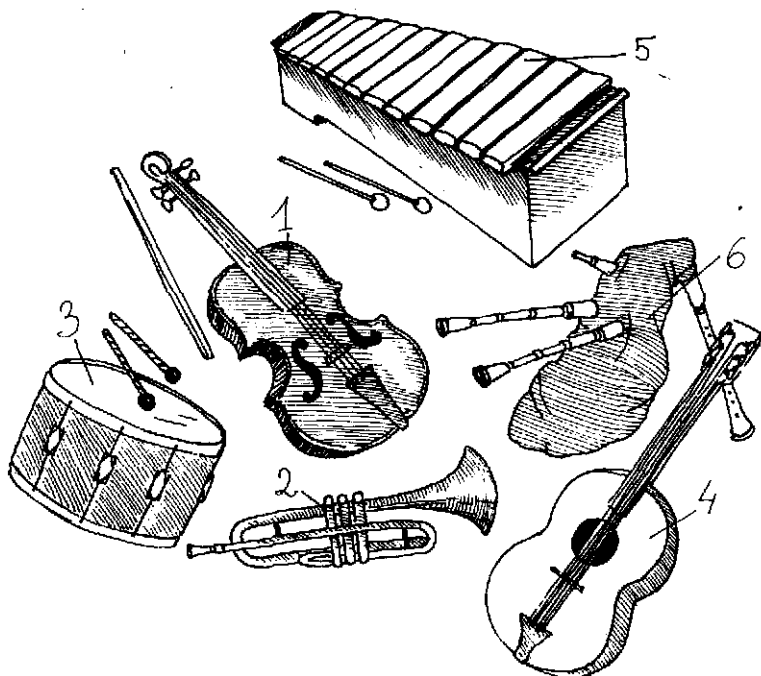

1. _____ 2. _r _____ 3. _____ s
 4. _____ 5. xy ____ ph _____ 6. b ____ p ____ s

** 371. MUSIC. Divide the following instruments into the four groups:

- a) string instruments
- b) brass instruments
- c) wood-wind instruments
- d) percussion instruments.

banjo	bugle	clarinet	cymbals	double-bass
drums	flute	guitar	harp	horn
oboe	piano	saxophone	tambourine	trumpet
violin	xylophone			

** 372. MUSIC. Which is the odd man out?

1. Which is not a string instrument:
 a) cello b) flute c) lute d) mandolin
2. Which is not a brass instrument:
 a) bassoon b) cornet c) trombone d) trumpet
3. Which is not a wood-wind instrument:
 a) bassoon b) oboe c) piccolo d) triangle

4. Which is not a percussion instrument:
a) chimes b) kettle-drums c) tom-tom d) whistle
5. Which is not a kind of voice:
a) bass b) baritone c) contralto d) recitative
6. Which is not a group of musicians:
a) band b) orchestra c) quintet d) polyphony
7. Which is not a kind of vocal music:
a) ballad b) carol c) lullaby d) symphony
8. Which is not a kind of music:
a) ballet b) opera c) oratorio d) symphony

* 373. MUSIC. Choose the correct answer.

1. Mozart composed music when he was still a child. He had a great for it.
a) ability b) force c) gift d) skill
2. I'm now going to play a piece "The Fall".
a) denominated b) entitled c) labelled d) nicknamed
3. The conductor was annoyed with the orchestra for not time.
a) beating b) keeping c) maintaining d) making
4. Schubert didn't complete one of his symphonies so it will always be
a) defective b) deficient c) unfinished d) unready
5. The attendance at the music festival all expectations.
a) excelled b) overcame c) overtook d) surpassed
6. Just as the violinist began to play, one of the on his violin broke.
a) chords b) cords c) strings d) wires
7. She sat at the piano and began to play a patriotic
a) music b) note c) sound d) tune
8. She never learnt the piano but she can play by
a) ear b) hand c) heart d) memory
9. The audience gave the soloist an enthusiastic when he entered.
a) applause b) clapping c) encore d) reception
10. Although I play the piano quite well, I still can't
a) play a score b) play the notes c) read a score d) read music
11. They sometimes play together in a
a) quartet b) quintet c) solo d) triplet
12. He's an exceptionally violinist and has won several prizes in international competitions.
a) artful b) competent c) gifted d) ingenious
13. As a child, Mozart was considered to be an infant
a) fantasy b) miracle c) prodigy d) sensation
14. She ought to singing with a voice like that.
a) take on b) take to c) take up d) undertake

15. The next on the programme will be a sonata by Beethoven.
a) bit b) item c) part d) piece
16. His performance was ; the audience was delighted.
a) faultless b) imperfect c) unmarked d) worthless
17. In the orchestra the oboe and the bassoon are two of the instruments.
a) breath b) lip c) mouth d) wind
18. When the artist opened his violin case, he found that someone had stolen his
a) arc b) bow c) rod d) stick
19. Which do you propose to play this piece in?
a) chord b) key c) notes d) score
20. The piano is badly out of , I'm afraid.
a) melody b) practice c) tune d) use
21. As a pianist his is brilliant, but I don't care much for his interpretation.
a) exhibitionism b) mastery c) technique d) technology
22. In this sonata, the first violin a nightingale.
a) reflects b) represents c) reproduces d) resembles
23. He never his early promise as a musician.
a) carried out b) discharged c) fulfilled d) performed
24. The choir stood in four rows according to their heights.
a) respectable b) respectful c) respective d) respected

374. MUSIC. Answer the clues.

1	_ _ _ _ _	C	_ _ _ _ _	
	2	_ _ _ _ _	O	_ _ _ _ _
3	_ _ _ _ _	_ _ _ _ _	N	_ _ _ _ _
	4	_ _ _ _ _	C	_ _ _ _ _
5	_ _ _ _ _	_ _ _ _ _	E	_ _ _ _ _
	6	_ _ _ _ _	R	_ _ _ _ _
	7	_ _ _ _ _	T	_ _ _ _ _

1. the person who stands in front of an orchestra (9)
2. the stick used by the person who stands in front of an orchestra (5)
3. a classical composition for an orchestra (8)
4. a performance of music by one person (7)
5. writes music (8)
6. singing and acting together (5)
7. a written sign for a musical sound of a particular length and pitch (4)

**** 375. MUSIC ON PAPER.** Match the names with the right number in the picture below.

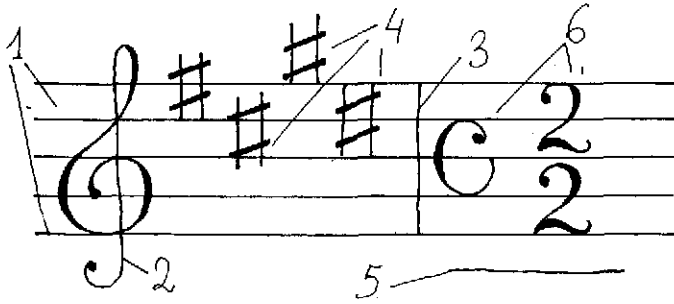

- | | |
|-------------------|--------------------|
| ... bar line | ... leger line |
| ... clef sign | ... staff |
| ... key signature | ... time signature |

**** 376. MUSICAL EXPRESSIONS.** Give Polish translation of the following terms.

- A flat
- A sharp
- clef
- major key
- minor key
- score
- staff (or stave)

377. POP-MUSIC. Complete with the words below.

- | | | | | |
|-------|-------|-------------|---------|----------|
| album | beat | disc-jockey | hit | juke-box |
| LP | lyric | single | sleeves | tempo |
| tune | | | | |

1. A plays records in discotheques.
2. A small record is called a
3. A large record is called a(n)
4. Records are kept in to preserve them from dust.
5. A long-playing record by a pop group is a(n)
6. In a pub records are played on a
7. The rhythm of the music is called the
8. The words of a song are called the
9. The melody of the song is the
10. The speed of the music is the
11. A song which is a great success is a

378. POP MUSIC. *Choose the right answer.*

1. They have music at the disco.
a) actual b) live c) living d) real
2. Shall we dance? They are playing our favourite
a) aria b) line c) music d) tune
3. Of course, I'll play the piano at the party but I'm a little out of
a) practice b) reach c) tune d) use
4. This is the guitar on which Lennon created some of his greatest hits.
a) actual b) contemporary c) genuine d) original
5. Is he really to judge a brass band contest?
a) capable b) competent c) efficient d) skilful
6. Some LPs have very imaginative designs on their
a) arms b) coats c) envelopes d) sleeves
7. The pop is emptier following the death of John Lennon.
a) life b) kingdom c) music d) scene
8. I don't think I know that song, but if you the tune I may be able to recognize it.
a) call b) chant c) hum d) sing
9. The Manhattan Transfer is an example of well-balanced singing by four artists.
a) duet b) lyric c) quartet d) tune
10. At the pop festival you will be able to hear music over a system of loudspeakers.
a) propelled b) realised c) relayed d) reproduced
11. The record-player needle the record badly.
a) broke b) scraped c) scratched d) tore
12. The acoustics in the concert hall were very poor, and it was necessary to voices of the performers.
a) amplify b) exaggerate c) extend d) increase
13. Italian TV has a young composer to write an opera for the TV's thirtieth anniversary.
a) appointed b) commissioned c) consulted d) ordered
14. Pop stars have to get used to people trying to get their
a) autographs b) names c) signatures d) sings
15. Tonight is a special night for our percussionist who has injured his hand and won't be able to play again.
a) benefit b) charity c) merit d) welfare

379. PHOTOGRAPHY. *Choose the right answer.*

1. This photo is rather because my camera was out of focus.
a) blotted b) blurred c) faded d) smeared
2. I want this roll of film developed and , please.
a) finished b) made c) printed d) stamped

3. I several photographs at our party.
a) got b) made c) shot d) took
4. Do you prefer photographs with a matt or gloss
a) completion b) finish c) polish d) surface
5. As I liked your photo, I had it
a) enlarged b) lengthened c) sized d) widened
6. That picture did not come out because you put your finger in front of the while you were taking it.
a) button b) lens c) shutter d) viewfinder
7. My sister is an enthusiastic photographer, and she all her own films.
a) develops b) glosses c) illustrates d) takes
8. I used an especially film to take this photo.
a) sensible b) sensitive c) sensual d) sensuous

* 380. **PHOTOGRAPHY.** Put each of the following words or phrases into its correct place in the passage below.

aperture	developing	film	flashbulbs
holder	image	indoors	lens
light	light rays	opening	picture
shutter	shutter release button	taking	viewfinder
wind			

The Parts of a Camera

A camera is a box with an aperture, or small, at one end. The lets light into the camera just as a window lets into a room. A shutter over the opening works like a Venetian blind. When you take a, you press the The opens, lets light into the camera, and quickly closes.

Light passes through a glass when it enters the camera. The lens bends the so that they form a sharp image on a section of the film. The appears on the film only after the film has gone through a complicated chemical process called

Before a picture, you look through of the camera to make sure that all of your subject will appear in the picture. After taking the picture, you the on to get the camera set for the next picture. Most cameras are equipped with a for flashbulbs. The use of adds extra light to a scene, especially

381. **FILMS.** Choose the right answer.

1. The music for the film has been taken from the works of Chopin.
a) incidental b) intervening c) passing d) supplementary
2. They all sat in the fourth of the cinema.
a) bench b) line c) rank d) row

3. Lawrence Olivier gave an excellent in the film.
a) act b) character c) performance d) play
4. There was an interesting of the film in the paper last week.
a) comment b) resume c) revision d) review
5. What time is the first of the film?
a) act b) performance c) programme d) show
6. There is an interesting nowadays to make films portraying love between youngsters.
a) direction b) surge c) tradition d) trend
7. "Please, put your empty cigarette packets in the bins provided."
a) deposit b) junk c) litter d) scrap
8. Although he is said to be a dramatic actor, he is starring in a musical.
a) actually b) currently c) lately d) recently
9. The latest video contains details of over one thousand films.
a) brochure b) catalogue c) leaflet d) prospectus
10. Hire charges for video tapes are on an overnight basis.
a) assessed b) calculated c) estimated d) valued
11. ". children are not admitted to this film."
a) Unaccompanied b) Unattached c) Unattended d) Unrelated
12. This film is not for children.
a) adapted b) agreeable c) right d) suitable
13. The film started with the heroine's death so most of it was shot in
a) backtrack b) flashback c) reverse d) switchback
14. I found the last scene extremely and well-directed.
a) moving b) pathetic c) pitiful d) sympathetic

382. FILM. Answer the clues.

1	C	
2	I	
3	N	
4	E	
5	M	
6	A	

1. animated movie
2. translation of the dialogue of a foreign film printed on the film
3. replacing the original voice sound-track of a film with a translation into a different language
4. film about vampires, black magic, etc.
5. a film showing some aspect of human or social activity
6. the script of the film

383. TELEVISION. Name the indicated parts of the picture below.

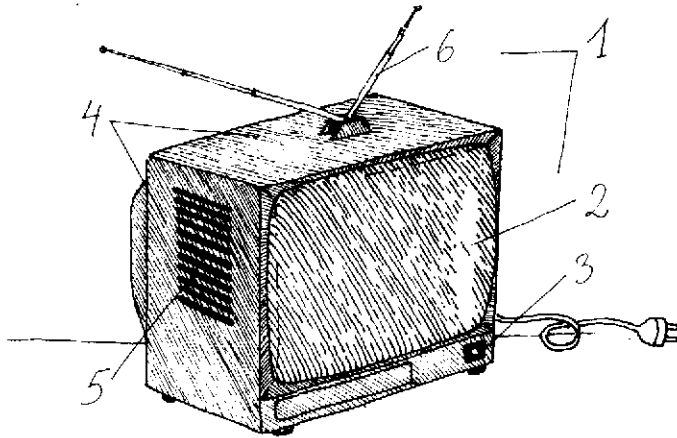

* 384. TELEVISION. Choose the right answer.

1. Did you see that about wildlife in Africa on television last week?
a) documentary b) history c) slapstick d) soap opera
2. All three TV channels provide extensive of sporting events.
a) broadcast b) coverage c) network d) vision
3. We hope to bring you further news of this in our next at midnight.
a) article b) bulletin c) episode d) piece
4. We covered a wide of topics in the interview.
a) collection b) extend c) number d) range
5. TVP Channel One tries to for all tastes.
a) cater b) furnish c) regard d) suit
6. We are interrupting this programme for a news
a) alarm b) alert c) flash d) signal
7. I must remember to my TV licence next week.
a) regain b) renew c) replace d) retain
8. The comedy in the silent films was especially funny.
a) clownish b) mocking c) slapstick d) witty
9. The programme was so successful that a series is being made.
a) after-effect b) backup c) by-product d) follow-up
10. There are several TV in Poland, and all of them allow advertising.
a) broadcasts b) canals c) channels d) screens
11. Violent programmes on TV may have a bad on children.
a) control b) influence c) power d) pressure
12. There is a fault at our television station. Please do not your set.
a) adjust b) change c) repair d) switch
13. The laughter on many comedies on TV isn't real laughter, it's laughter.
a) bottled b) canned c) corked d) wrapped

14. There are many on television where a team of people have to answer questions.
a) inquiries b) puzzles c) quizzes d) riddles
15. The poor reception on your TV is probably due to outside
a) interception b) interference c) interruption d) intervention

385. ART. Choose the right answer.

1. Mr Cheater made a living works by famous painters.
a) devising b) faking c) pretending d) shamming
2. A sculpture by Rodin fetched more than two million dollars at the last month.
a) auction b) gallery c) museum d) sale
3. The of Rembrandt's paintings finishes next week.
a) demonstration b) exhibition c) show d) spectacle
4. They thought the painting was genuine but it turned out to be
a) a facsimile b) an imitation c) a replica d) a reproduction
5. There was no difference between the original and the copy.
a) discernible b) discoverable c) knowable d) understandable
6. Mr Adventurous has taken painting since he retired.
a) down b) in c) over d) up
7. A young art student acted as our when we visited the museum.
a) coach b) conductor c) guide d) lead
8. This self-portrait did not come to until after the artists's death.
a) light b) range c) sight d) view
9. Mr Vernix is the greatest expert on techniques of painting.
a) alive b) live c) living d) nowadays
10. Children and pensioners are admitted to the museum at prices.
a) decreased b) less c) reduced d) undercharged
11. On examination by experts, the picture turned out to be a
a) fabrication b) fake c) fraud d) sham
12. In the right-hand corner of the portrait there is a flower.
a) front b) high c) top d) up
13. He is sometimes considered to be an outstanding artist, but I consider his work to be quite
a) common b) intermediate c) mediocre d) moderate
14. All visitors are requested to with the regulations.
a) agree b) assent c) comply d) consent
15. He made some sketches which would serve as guides when he painted the actual landscape.
a) elementary b) introductory c) preliminary d) primary
16. Admission to the gallery is except on Saturdays and Sundays when a charge of one dollar is made.
a) allowed b) free c) nothing d) paid

17. The paintings are hung in heavy gold
a) easels b) frames c) fringes d) rims
18. This beautiful portrait is to Rubens.
a) assigned b) attached c) attributed d) prescribed
19. He earns his living by works of art.
a) recovering b) renewing c) restoring d) reviving
20. That landscape is somewhat of Rembrandt's early work.
a) memorable b) mindful c) reminiscent d) similar
21. The portrait you see here is a very good of my mother.
a) appearance b) likeness c) reproduction d) resemblance
22. I would love to go to the exhibition with you, but I'm afraid I can't the time.
a) leave b) lose c) save d) spare
23. He said he had never across a painting which pleased him more.
a) come b) happened c) seen d) viewed
24. I made it quite clear that I had no of selling the portrait.
a) aim b) intention c) meaning d) purpose

386. PAINTING. Name the following kinds of paintings.

1. l _____
2. _____
3. s _____ l _____

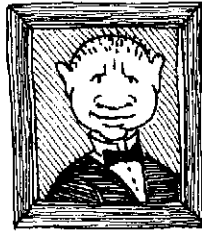

2



1

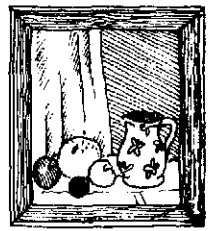

3

*** 387. PAINTING.** Name the following things found in the artist's studio.

1. p _____
2. c _____
3. e _____ l _____
4. _____



3

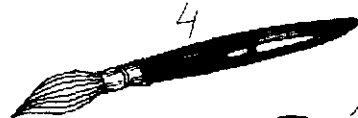

4

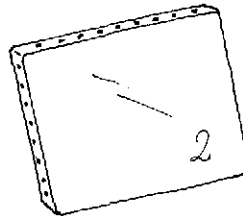

2

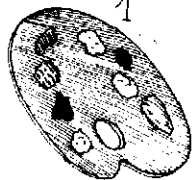

1

**** 388. PAINTING.** Match the terms on the left with their definitions on the right.

- | | |
|-----------------|---|
| 1. caricature | a) a picture made with a pencil |
| 2. cartoon | b) a drawing showing the parts of something to explain how it works |
| 3. collage | c) a drawing showing by a line the connection between two quantities |
| 4. diagram | d) a rough drawing without many details |
| 5. drawing | e) a picture to go with the words of a book |
| 6. fresco | f) a picture in solid black |
| 7. graph | g) a picture painted in water colour on a surface of fresh wet plaster |
| 8. illustration | h) woven cloth hanging on a wall, with pictures woven from coloured wool or silk |
| 9. mural | i) a humorous drawing, often dealing with something of interest in the new in an amusing way |
| 10. silhouette | j) a representation of a person made so that aspects of his or her appearance appear more noticeable than they really are |
| 11. sketch | k) a picture made by an unusual combination of bits of paper, cloth, metal, etc. |
| 12. tapestry | l) a picture painted directly onto the wall |

389. PAINTINGS. What is the shape of the following paintings?

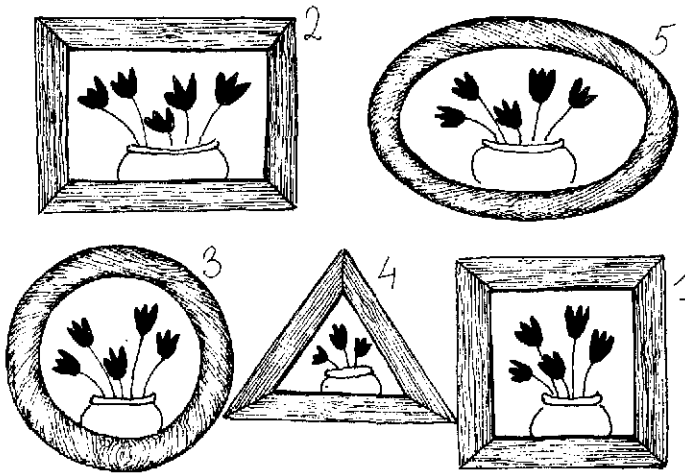

1. s _____
2. r _____ a r
3. c _____ a r
4. t _____ a r
5. o _____

*** 390. PAINTING.** Answer the clues.

1	_____	R	—
	2	E	—
3	_____	M	
	4	B	_____
	5	R	_____
	6	A	_____
	7	N	_____
8	_____	D	_____
	9	T	_____

1. work of art made by carving in stone or wood (9)
2. method of carving in which a design stands out from a flat surface (6)
3. style in art represented by Manet or Renoir (13)
4. an instrument for painting (5)
5. to cut eg. words on wood, stone or metal (7)
6. material used for sculpting (6)
7. a piece of strong rough cloth used for an oil painting (6)
8. picture with a view (9)
9. precious; is used in making jewellery (5)

391. PLAYING CARDS. Give the names of the following suits.

1. _____ e s
2. _____ t s
3. _____ b s
4. _____ d s

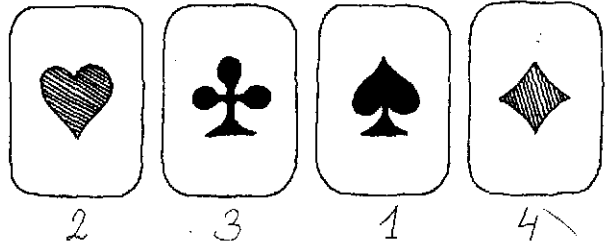

392. PLAYING CARDS. Give the names of the following cards.

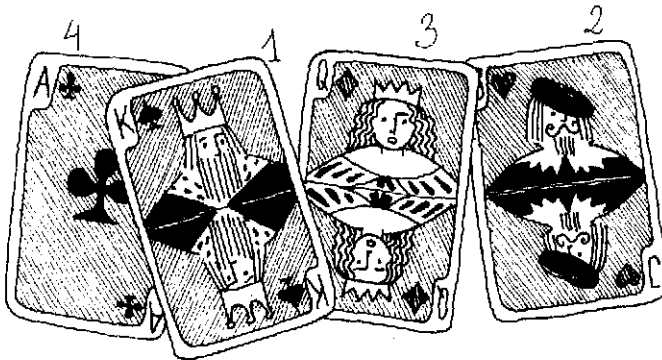

1.
2.
3.
4.

* 393. GAMBLING. Answer the questions.

1. What is a playing card which is a king, queen or jack called?
A p _____ card.
2. What is an extra playing card, which in some games may have any value, called?
_____ r.
3. What is any card of a suit chosen to be of higher rank than the other three suits during a **game** called?
_____ p.
4. What do all cards together form?
A _____ of cards.
5. What is giving a number of cards to each player called?
_____ ing.
6. What must you do with the cards before dealing?
You must s _____ them.
7. What is a small 6-sided block of wood, etc. with 1—6 spots on each side, used in games of chance, called?
_____ .
8. What is the name of a building used for playing games for money called?
_____ o.
9. What is the card game in which players try to make a winning combination of cards worth 21 points called?
B _____ or p _____ n.

394. GAMBLING. Choose the right answer.

1. If you've got a of cards. I'll show you some tricks.
a) collection b) pack c) packet d) set
2. Here's a coin. You call: or tails?
a) Backs b) Blanks c) Heads d) Tops
3. We can't play with this pack of cards; the king of hearts and the ace of diamonds are
a) absent b) departed c) lacking d) missing
4. The tourists at the casino were playing for very high
a) bets b) bids c) profits d) stakes
5. the cards before you deal.
a) Jumble b) Muddle c) Rattle d) Shuffle
6. Did you go to the casino when you were in Monte Carlo?
No, I never
a) bet b) gamble c) hazard d) play
7. If you can the clues to this puzzle, you could win a prize.
a) unbind b) unravel c) untangle d) unwind
8. Pete always puts money into gambling machines in the hope of winning the
a) jackpot b) rot c) premium d) share

9. A lot of our free time is chess.
 a) given up to b) handed over to c) taken over by d) taken up by
10. Many people are taking up activities in their spare time.
 a) free b) hobby c) leisure d) pleasure

* 395. CHESS. Give the names of the following pieces in chess.

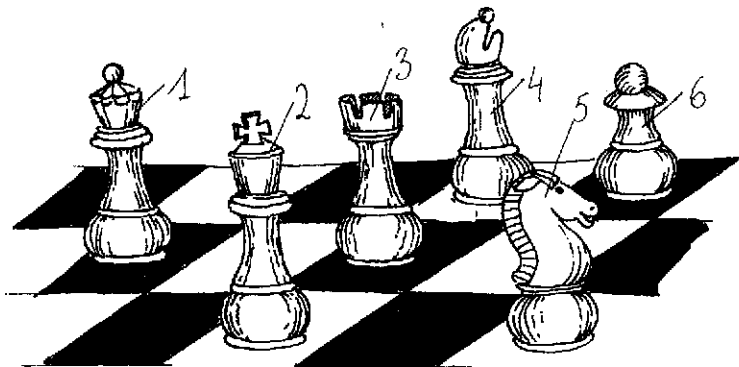

1. _____ n
 4. b _____
2. _____
 5. k _____
3. c _____ or r _____
 6. p _____

XIX. Sports

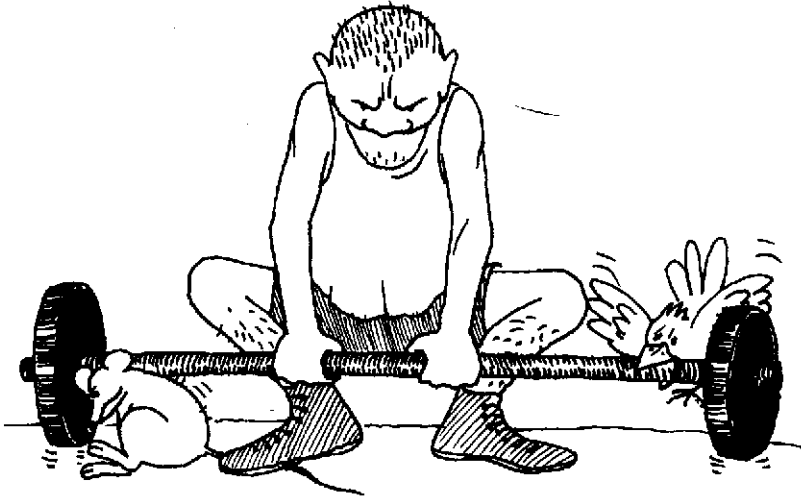

He (at football match): "That fellow out there playing centre-forward will be our best man before the season is over."

She: "Oh, Jimmy, this is so sudden."

*

Tom was staying as a guest on an English farm, and was feeling rather bored. "Now I am busy at the moment, but if you want to amuse yourself for an hour or so, take my gun and two gun dogs and go and do some shooting," said the farmer.

Fifteen minutes later Tom was back again. "Have you got any more gun dogs, sir?"

396. SPORTS. Give names for the illustrated sports.

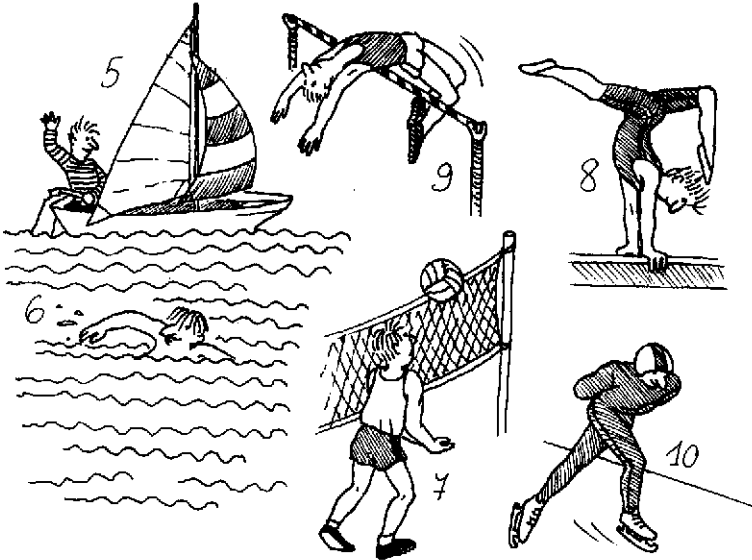
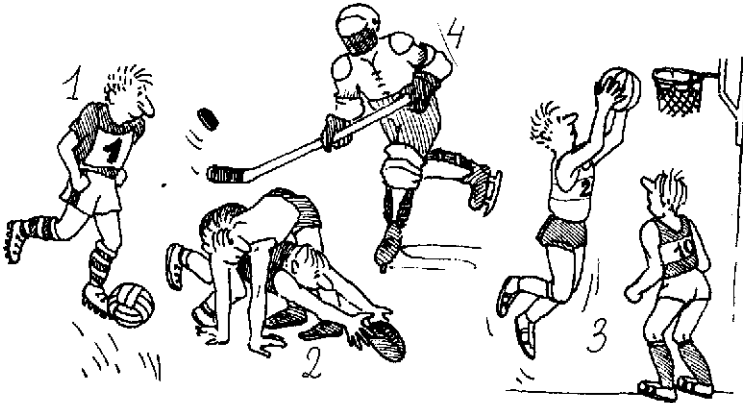

- 1. _____ or s _____
- 2. _____ y
- 3. _____ t _____
- 4. ____ c _____
- 5. _____ l _____

- 6. _____ m _____
- 7. _____ - ball
- 8. g _____
- 9. h _____ j _____
- 10. ____ k _____

397. SPORTS. Match the following sports with the right pictures.

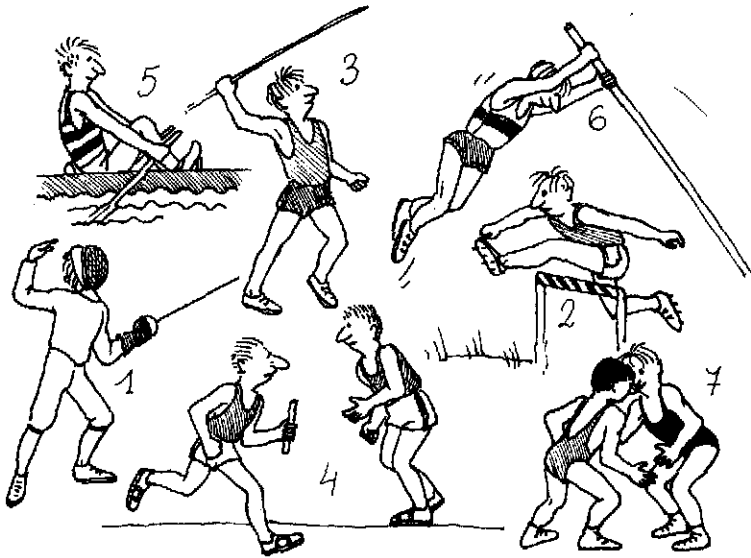

- ... rowing
- ... javelin
- ... pole vault
- ... hurdles
- ... fencing
- ... relay race
- ... wrestling

* 398. SOCCER. Complete the following sentences with the words or phrases from the list below.

- | | | | |
|----------------------------|------------|--------|------------------------|
| captain | coach | draw | fair |
| football ground (or pitch) | footballer | fouls | free (or penalty) kick |
| goal | kick-off | league | opponents |
| referee | score | soccer | |

1. What Europeans call "football", Americans call
2. The instructor of the team is the
3. When you play in a football team you are a
4. The games take place on a
5. The leader of the team is the
6. The man in the is the goal-keeper.
7. The beginning of the match is the
8. During the match each team tries to as many goals as possible.
9. When the teams have scored the same number of goals we say it's a
10. The players of the other team are the
11. The man who enforces the rules during the game is the
12. Playing correctly is called play.
13. Unfair moves are called
14. When a player breaks the rules the other team may get a
15. A federation of football clubs is called a football

399. SPORTS. Fill in the table putting "+" where appropriate.

SPORTS	TEAM	INDIVIDUAL	COMBATIVE	INDOOR	OUTDOOR
rugby					
relay racing					
jumping					
golf					
fencing					
skiing					
boxing					
cricket					
riding					
soccer					

* 400. FOOTBALL TEAM. Match the names of the footballers with their position on the field.

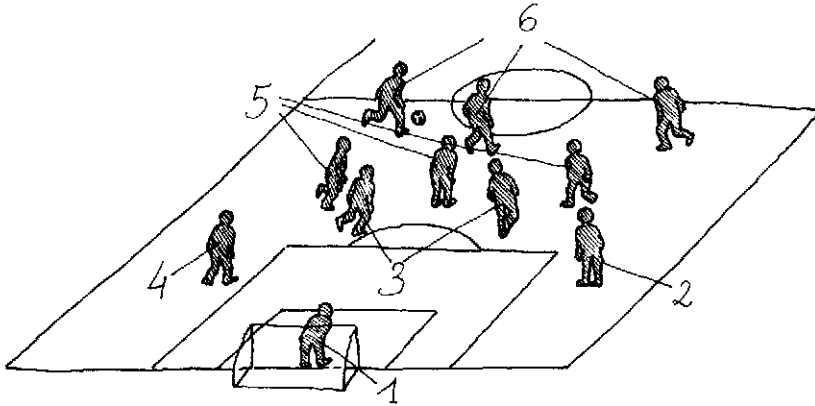

- ... centre back
- ... goal keeper
- ... right back
- ... left back
- ... midfield players
- ... strikers

* 401. FOOTBALL. Choose the right answer.

- This year our team are the favourites to win the cup.
a) firm b) full c) grand d) hard
- The team's coach insisted on a programme of training before the big match.
a) harsh b) rigorous c) severe d) searching
- The team has practised hard so that it could the trophy.
a) regain b) replace c) restore d) return
- The team's recent wins have them for the semi-finals.
a) fitted b) matched c) promoted d) qualified

5. John is always about how well he plays football.
a) boasting b) flaunting c) parading d) puffing
6. His poor standard of play fully justifies his from the team for the next match.
a) ban b) exception c) exclusion d) rejection
7. The footballer was the field for kicking the referee.
a) brought off b) put off c) sent off d) taken off
8. The footballer scored four , so his team won the match.
a) aims b) games c) goals d) scores
9. The fan shouted at the of his voice.
a) head b) height c) limit d) top
10. The at the football match became violent when their team lost.
a) customers b) groups c) observers d) spectators
11. Our village team were hopelessly by the professional visitors.
a) outclassed b) outgrown c) outnumbered d) outraced
12. He was nervous at the beginning of the game but later he came into his
a) best b) nature c) own d) style
13. The said it was a foul and gave us a free kick.
a) controller b) director c) referee d) umpire
14. In his first game for our team he a goal after two minutes.
a) earned b) gained c) scored d) won
15. Manchester United are playing Birmingham this Sunday.
a) against b) facing c) opposite d) with
16. Even though the match wasn't very exciting, the managed to make it sound interesting.
a) announcer b) commentator c) narrator d) presenter
17. The football match resulted in a
a) draw b) equaliser c) loss d) zero
18. The football team won partly because they had been trained by such a good
a) coach b) director c) instructor d) teacher
19. After their long period of training, the footballers were in good
a) cut b) figure c) shape d) style
20. The referee the goal because of a previous infringement.
a) annulled b) demolished c) disallowed d) disqualified
21. Having lost the match, the team travelled home in spirits.
a) cold b) dark c) empty d) low
22. As they watched the match, the crowd in unison.
a) bellowed b) chanted c) crowed d) intoned
23. We still don't know who is going to win, because at half-time the score is one
a) all b) each c) equal d) together
24. I advise you not to the referee's decision.
a) condemn b) condone c) conduct d) contest
25. As the minutes ticked by and we held on to our narrow lead our hopes of victory steadily.
a) arose b) aroused c) raised d) rose

* 402. SPORTS. Complete these expressions using the things on the right.

- | | |
|----------------|-----------|
| 1. a boxing | a) course |
| 2. a golf | b) court |
| 3. a football | c) pitch |
| 4. a race | d) pool |
| 5. a running | e) ring |
| 6. a skating | f) rink |
| 7. a squash | g) table |
| 8. a swimming | h) track |
| 9. a tennis | |
| 10. a billiard | |

403. SPORTS. Fill in the table matching the sports with the right kinds of engagements.

	GAME	MATCH	TOURNAMENT	COMPETITION	RACE	CONTEST
football						
skiing						
chess						
tennis						
shooting						
horse						
boxing						
motor						
fencing						

404. SWIMMING. Give the names for the illustrated ways of swimming.

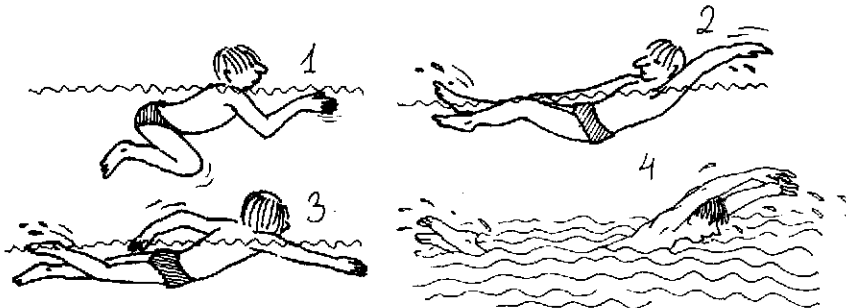

1. _ _ _ _ _ s _ _ _ _
 2. b _ _ _ _ s _ _ _ _

3. _ r _ _ _ _
 4. b _ t _ _ _ _

* 405. HORSE RIDING. Match the words with the right numbers in the picture.

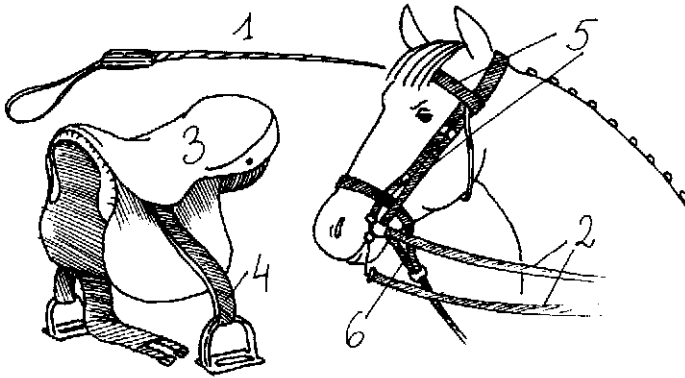

- ... bridle ... harness ... reins ... riding crop
 ... saddle ... stirrup

* 406. SPORTS. Indicate which equipment is used in the following sports.

	ball	bat	bow	club	gloves	oar	racket	rod	stick
angling									
archery									
baseball									
boxing									
cricket									
golf									
hockey									
ping pong									
rowing									
squash									

* 407. SPORTS. Choose the correct answer.

- I met Pete his bicycle along the pavement.
 a) pulling b) rolling c) turning d) wheeling
- He was from the competition because he had not complied with the rules.
 a) banished b) disqualified c) forbidden d) outlawed
- Some of the best golf are to be found in England.
 a) courses b) courts c) pitches d) tracks
- Sport is a good for aggression.
 a) let off b) offshoot c) outlet d) way out

5. When she was told she had won the first prize in the competition, she had to **herself** to make sure she wasn't dreaming.
a) grasp b) pinch c) scratch d) seize
6. This is the running where the first 4 minute mile was run.
a) circle b) course c) ring d) track
7. Have you been able to book us a tennis for tomorrow?
a) court b) field c) ground d) pitch
8. The boxer and almost fell when his opponent hit him.
a) scrambled b) shattered c) staggered d) stammered
9. He has always been supporter of his local rugby team.
a) a forcible b) an unbeaten c) a staunch d) a sure
10. They stood glowering at each other, their fists ready for action.
a) clasped b) clenched c) grasped d) joined
11. It seems that the world record for this event is almost impossible to
a) balance b) beat c) compare d) meet
12. The boxer his opponent as hard as he could.
a) knocked b) punched c) slapped d) touched
13. Our team faced fierce in the relay races.
a) attack b) competition c) contest d) opponents
14. She is a good runner but she's not much good at
a) barriers b) fences c) hurdles d) jumps
15. He ran four of the course in half an hour.
a) hurdles b) laps c) sprints d) vaults
16. Most tennis stars learn the game at an early age.
a) hopeful b) prospective c) will-be d) willing
17. Mary tells me she is my horse in the Derby.
a) backing b) betting c) gambling d) staking
18. I always feel before the start of a race.
a) jerky b) jittery c) timid d) unsteady
19. All the athletes were wearing suits when they came into the stadium.
a) jogging b) running c) sports d) track
20. The new sports centre for all kinds of leisure activities.
a) caters b) deals c) furnishes d) supplies
21. I'm afraid we shall have to call the match on account of the bad weather.
a) back b) in c) off d) on
22. I tried to my disappointment at losing by cheering the winner loudly.
a) hide b) mask c) shield d) veil
23. The fastest runner took the just five metres before the finishing line.
a) advance b) head c) lead d) place
24. There is a lot of friendly between the supporters of the two teams.
a) contention b) contest c) defiance d) rivalry
25. He's to win. No one else in the race stands a chance.
a) bound b) liable c) probable d) unavoidable

Key

I. Air Travel

1.
1 — airship 3 — kite 5 — hovercraft 7 — glider
2 — helicopter 4 — airliner 6 — spaceship

2.
1. c 5. d 9. d 13. a 17. c 21. b 25. a
2. c 6. b 10. a 14. a 18. d 22. c 26. d
3. b 7. b 11. b 15. b 19. c 23. d 27. d
4. c 8. c 12. b 16. d 20. c 24. a 28. b

- 3.
- | | | | | | | | | | |
|----|---|---|---|---|---|---|---|---|---|
| 1 | A | I | R | P | O | R | T | | |
| 2 | | F | L | I | G | H | T | | |
| 3 | S | T | E | W | A | R | D | | |
| 4 | | T | A | K | E | - | O | F | F |
| 5 | | P | I | L | O | T | | | |
| 6 | H | A | N | G | A | R | | | |
| 7 | | L | A | N | D | I | N | G | |
| 8 | | A | V | I | A | T | I | O | N |
| 9 | | C | R | E | W | | | | |
| 10 | | G | L | I | D | E | R | | |

- ** 4.
1 — nose 3 — fuselage 5 — hatch 7 — wing
2 — cockpit 4 — fin 6 — undercarriage 8 — rudder

5. **Airliner**

Airliners, or PASSENGER planes, differ from light planes not only in SIZE but also in speed and equipment. They are designed to CARRY a greater number of people over longer DISTANCES without stopping to refuel.

A passenger airliner has a comfortable CABIN with soft carpets, adjustable upholstered SEATS, washrooms, and individual AIR VENTS and reading lights. It has a GALLEY for preparing food. Many airlines offer TOURIST, or economy class service, which costs less than first class travel.

The CRUISING SPEED of four-engine airliners ranges from about 350 mph for propeller-driven planes to more than 500 mph for JET PROPELLED planes.

The CREW of an airliner works as a team to make the trip smooth and pleasant. While the passengers take their seats, the pilot or CAPTAIN, co-pilot, flight engineer, and stewardesses prepare the plane for FLIGHT. The pilot, assisted by the CO-PILOT, checks the instruments and tests the controls. The FLIGHT ENGINEER checks the other mechanical equipment. The stewardesses check the PASSENGER LIST, make sure that the passengers fasten their SAFETY BELTS for TAKE OFF. Later the STEWARDESSES distribute magazines, serve meals, and do other things to make the TRIP enjoyable.

II. Animals

** 6.

1. b	4. b	7. b	10. d	13. b
2. a	5. b	8. c	11. b	14. b
3. d	6. a	9. b	12. c	15. c

** 7.

1. cow	3. drake	5. gander	7. lioness	9. hind
2. bitch	4. vixen	6. cock; rooster	8. ewe	10. mare

** 8.

1. a	3. l	5. c	7. b	9. d	11. g
2. h	4. f	6. k	8. j	10. c	12. i

** 9.

1. b	5. c	9. d	13. a	17. d	21. d
2. b	6. c	10. d	14. c	18. b	22. c
3. a	7. d	11. d	15. b	19. a	23. d
4. b	8. a	12. b	16. a	20. d	

** 10.

1. nestling	6. duckling	10. chick/chicken	12. cub
2. kitten	7. (elephant) calf	11. a. foal	13. piglet
3. calf	8. cub	b. colt	14. lamb
4. fawn	9. kid	c. filly	15. (wolf-)cub
5. puppy			

11.

1. c	3. d	5. a	7. c	9. b	11. b
2. c	4. a	6. c	8. a	10. b	

** 12.

1. a; b	4. a; c	7. c	10. a; b; c	13. c
2. a; c	5. a; b; c	8. c	11. b; c	14. b; c
3. b	6. a	9. a	12. a	15. c

* 13.

1. d	6. b	11. d	16. a	21. b
2. d	7. a	12. b	17. d	22. a
3. b	8. a	13. c	18. a	23. a
4. d	9. d	14. d	19. b	24. c
5. a	10. d	15. d	20. b	25. c

* 14.

1. d	5. c	9. t	13. r	17. b
2. m	6. a	10. g	14. s	18. l
3. h	7. c	11. f	15. j	19. k
4. n	8. p	12. o	16. l	20. u

15.

	FEATHERS	FUR	HIDE	SCALES	SHELL	SKIN	WOOL
beaver		+					
crocodile				+			
eagle	+						
cow			+				
cat		+					
elephant						+	
frog						+	
llama							+
lobster					+		
monkey		+					
oyster					+		
parrot	+						
pig						+	
pike				+			
stork	+						
tiger		+					
turtle					+		

**** 16.**

1. brood of young chickens
2. colony of ants; bees; birds
3. flight of birds; geese
4. flock of birds; geese; sheep
5. gaggle of geese
6. herd of cattle; deer
7. litter of puppies
8. pack of dogs; hounds for hunting; wolves
9. pride of lions
10. shoal of fish; whales
11. school of fish; whales
12. swarm of bees
13. team of oxen for ploughing
14. troop of ants; monkeys

17.

- | | | | | |
|------|-------|-------|-------|-------|
| 1. c | 6. a | 11. c | 16. c | 21. b |
| 2. a | 7. b | 12. d | 17. a | 22. b |
| 3. d | 8. b | 13. b | 18. d | 23. c |
| 4. b | 9. c | 14. a | 19. c | 24. b |
| 5. c | 10. d | 15. c | 20. a | |

*** 18.**

- | | | | | |
|------|------|------|------|-------|
| 1. b | 3. d | 5. c | 7. d | 9. a |
| 2. b | 4. d | 6. a | 8. c | 10. b |

19.

- | | | | |
|------|------|------|-------|
| 1. a | 4. c | 7. c | 10. d |
| 2. c | 5. c | 8. c | 11. a |
| 3. c | 6. b | 9. a | 12. c |

** 20.

Some Insects

A BEE makes honey, but a WASP, also black and yellow, does not.

BUTTERFLIES are more often seen by day and MOTHS by night — both may develop from CATERPILLARS and later PUPAE. Clothes moths lay eggs in clothes.

A MOSQUITO bites or stings and can spread malaria; the GNAT, very common in Poland, is less dangerous.

BETTERLES are usually black, with hard wing covers; CRICKETS may have an almost continuous high chirp, heard at night; GRASSHOPPERS jump through the grass; FLEAS jump and bite animals and people; MAGGOTS are found in fruit and peas; SPIDERS spin webs, which when dirty are called COBWEBS.

21.

- | | | | | |
|------|------|------|------|-------|
| 1. a | 3. a | 5. a | 7. b | 9. c |
| 2. a | 4. a | 6. d | 8. a | 10. b |

22.

	H		G	U	L	L	
	E		I		I		
K	A	N	G	A	R	O	O
I			O	A		N	
D	E	E	R		F		
	L		I		F	L	Y
	E	E	L		E		
	P		L		E		
	H	E	A	D		A	
	A				E	G	G
	N					L	
	T	U	R	T	L	E	

III. The Army

23.

- | | | | | |
|------|------|------|-------|-------|
| 1. b | 4. c | 7. c | 10. c | 13. c |
| 2. d | 5. c | 8. a | 11. b | 14. b |
| 3. c | 6. b | 9. b | 12. d | 15. c |

24.

- | | | | | | |
|------|------|------|------|-------|-------|
| 1. d | 3. d | 5. d | 7. d | 9. b | 11. b |
| 2. d | 4. b | 6. a | 8. c | 10. a | 12. d |

** 25.

- | | | | | | |
|------|------|------|-------|-------|-------|
| 1. c | 4. b | 7. k | 10. h | 13. r | 16. o |
| 2. d | 5. a | 8. f | 11. g | 14. n | 17. l |
| 3. c | 6. i | 9. j | 12. m | 15. p | |

26.

1. They suffered heavy LOSSES in the last battle.
2. If Napoleon's TRIUMPH/VICTORY at Austerlitz was the high-point of his military career, his CAMPAIGN to take Moscow was a failure leading to the DEFEAT at Waterloo which was his end.
3. Her son is a CASUALTY of the Vietnam war: he lost both his legs.
4. The German unconditional SURRENDER was accepted by the Allied Powers.
5. The Norman CONQUEST of Britain began in 1066.
6. The commanders agreed on a CEASEFIRE/TRUCE for a period of five hours to allow the removal of the wounded.

* 27.

- | | | | | |
|------|------|------|-------|-------|
| 1. a | 4. d | 7. c | 10. d | 13. c |
| 2. c | 5. d | 8. d | 11. b | 14. c |
| 3. b | 6. a | 9. d | 12. d | 15. c |

** 28.

A Typical Day

A typical day for a SOLDIER depends on his ASSIGNMENT. During peacetime at a permanent ARMY POST, the bugler sounds REVILLE at 5:30 or 6 a.m. to waken the TROOPS. After ROLL CALL, the men wash and shave, go to the MESS HALL for breakfast.

Next they form ranks for DRILL. They practice various MARCHING routines and the use and care of WEAPONS. Other men take care of housekeeping details. The COOKS begin their work long before reveille. The first sergeant and company clerk handle the ADMINISTRATIVE DUTIES and "paperwork" of the unit. The mess sergant SUPERVISES the cooks. The SUPPLY SERGEANT cares for and issues clothing and equipment. Each Saturday, the UNIT COMMANDER inspects the entire company.

Drill is usually completed by 11 a.m. After dinner at noon, the men return to their jobs or TRAINING. All day and night, some officers and men are on GUARD DUTY. They are posted at warehouses, motor pools, storage dcpts, and around the PERIMETER.

Parades and REVIEWS sometimes take place in the afternoon until about 5 p.m. After supper, SOLDIERS not assigned special duties may do as they please. Most army posts have RECREATION buildings called service clubs. Each COMPANY-SIZED UNIT has a clubroom called a DAYROOM. Men who do not have permission to stay out must be in their BARRACKS by 11 p.m. and lights must be turned off.

** 29.

- i. WEAPONS: bazookas, guided missiles, howitzers, machine guns, mortars, rifles
- ii. SHIPS: aircraft carriers, cruisers, destroyers, mine-sweepers, submarines, tugs
- iii. AIRCRAFTS: bombers, fighters, helicopters.

* 30.

The Infantry

Combat units of the army consist of SOLDIERS trained and equipped to fight ENEMY FORCES. Infantry, ARTILLERY, and armoured units are called the combat arms, because they do the DIRECT FIGHTING. Other UNITS of the army, called the services, support and serve the COMBAT ARMS.

The INFANTRY is the army's largest arm. Infantrymen must SEIZE, occupy and DEFEND land areas. They bear the heaviest share of CLOSE COMBAT. INFANTRYMEN throw GRENADES and fire rifles, machine GUNS, mortars, BAZOOKAS and pistols.

They enter battle on FOOT, by helicopter, PARACHUTE, or in armoured PERSONNEL CARRIERS.

** 31.

- | | | | | | |
|------|------|------|------|-------|-------|
| 1. j | 3. a | 5. l | 7. c | 9. k | 11. i |
| 2. f | 4. b | 6. e | 8. g | 10. h | 12. d |

32.

1. enemy soldiers; wounded; prisoner
2. bombers; border
3. colonel; sergeant; private
4. army; airforce; navy
5. marines

IV. Clothing

33.

- | | | | |
|--------------|-------------|--------------|-------------------|
| A man: | A woman: | A boy: | Washing: |
| 1. jacket | 1. blouse | 1. tee-shirt | 1. bra |
| 2. shirt | 2. skirt | 2. shorts | 2. pyjamas |
| 3. bow tie | 3. pullover | 3. socks | 3. dress |
| 4. waistcoat | 4. tights | 4. cap | 4. apron |
| 5. trousers | 5. boots | 5. cardigan | 5. petticoat/slip |
| 6. suit | | | |
| 7. overcoat | | | |
| 8. socks | | | |
| 9. shoes | | | |
| 10. scarf | | | |

34.

- | | | |
|-----------------|-------------------|-------------|
| 1 — button-hole | 6 — breast pocket | 11 — crease |
| 2 — lapel | 7 — label | 12 — buckle |
| 3 — lining | 8 — cuff | 13 — belt |
| 4 — loop | 9 — sleeve | 14 — fly |
| 5 — collar | 10 — seam | 15 — zip |

35.

- | | | | | |
|------|------|------|-------|-------|
| 1. d | 4. c | 7. b | 10. a | 13. a |
| 2. a | 5. c | 8. a | 11. d | 14. b |
| 3. b | 6. b | 9. b | 12. b | 15. d |

36.

- | | | | | |
|------|------|------|------|-------|
| 1. d | 3. d | 5. c | 7. a | 9. c |
| 2. c | 4. a | 6. c | 8. d | 10. a |

37.

S S S S S S S S
W A I S T C O A T H O H
E L O L R A I N C O A T
A V C E I R K W
T I B K P T F L Y
E R I I E L U A
R N E C K W E A R R
R I N G Y G D

38.

- 1. b 4. b 7. d 10. a 13. d
- 2. b 5. d 8. c 11. a 14. a
- 3. d 6. b 9. d 12. d

39.

	above	below	both	women	men	both
blazer	+					+
nightdress			+	+		
skullcap	+				+	
slip			+	+		
suit			+			+
tights		+		+		
top hat	+				+	
turtleneck	+					+
underwear			+			+

40.

- 1. clothes 3. dresses 5. cloths 7. dressing 9. cloth
- 2. clothing 4. clothe 6. material/cloth 8. drcss 10. dressings

41.

- 1. striped 3. checked
- 2. spotted 4. plain

42.

- 1. vertically 2. horizontally 3. diagonally

43.

- 1. i 3. l 5. j 7. a 9. d 11. h
- 2. c 4. k 6. e 8. g 10. f 12. b

44.

- 1. c 3. a 5. c 7. d 9. d
- 2. d 4. d 6. b 8. c

45.

- 1 — do not iron 6 — dry-clean only
- 2 — hand-wash in lukewarm water 7 — dry flat
- 3 — do not use chlorine bleach 8 — tumble dry
- 4 — hang to dry 9 — do not wash
- 5 — drip-dry

46.

- 1. b 3. d 5. d 7. a 9. d 11. d
- 2. c 4. d 6. a 8. c 10. b 12. a

47.

1. b 2. c 3. a 4. a 5. a

48.

Cleaning

It is as well to read all those little TAGS that dangle from GARMENTS. The tags give DIRECTIONS for cleaning or WASHING, and pressing.

Most WOOLLEN sweaters can be hand-washed in LUKEWARM or cold water. They should be SQUEEZED gently, not wrung out.

Some FABRICS, such as CORDUROY, should be left to DRIP dry without squeezing or WRINGING.

Some garments that are CREASED after a wearing may lose these creases if they are carefully HUNG up overnight.

SUEDE pocketbooks and SHOES should be brushed before and after each WEARING.

Kid and CALFSKIN shoes should be POLISHED to keep the LEATHER soft and SUPPLE.

49.

- | | |
|------------------|----------------|
| 1 — safety-pin | 5 — zipper |
| 2 — button | 6 — pin |
| 3 — hook and eye | 7 — snap |
| 4 — buckle | 8 — press stud |

50.

1. a 2. b 3. a 4. d 5. a 6. d

51.

- | | | |
|----------------|-------------------|-------------------|
| 1. needle | 2. pattern | 3. pin cushion |
| 4. scissors | 5. tape measure | 6. thimble |
| 7. thread | 8. sewing machine | 9. reel of cotton |
| 10. safety pin | | |

52.

- | | | | | | | |
|------|------|------|------|-------|-------|-------|
| 1. b | 3. c | 5. d | 7. d | 9. a | 11. b | 13. c |
| 2. c | 4. b | 6. d | 8. a | 10. d | 12. d | 14. c |

53.

- | | | | | | |
|------|------|------|------|-------|-------|
| 1. d | 3. c | 5. b | 7. d | 9. b | 11. d |
| 2. a | 4. c | 6. d | 8. b | 10. b | 12. d |

54.

- | | | | | |
|------|------|------|------|-------|
| 1. d | 3. d | 5. d | 7. c | 9. b |
| 2. d | 4. d | 6. c | 8. b | 10. c |

* 55.

1. d 2. d 3. d 4. b 5. a

56.

- | | | | | |
|--------------|------------|-----------|-----------|-----------|
| 1. designers | 3. dye | 5. soak | 7. black | 9. rack |
| 2. laundry | 4. bargain | 6. shrink | 8. afford | 10. shade |

57.

- | | | | |
|-------------|----------------|------------------|--------------|
| 1. — baggy | 3. — checked | 5. — floral | 7. — pleated |
| 2. — belted | 4. — crew neck | 6. — high heeled | 8. — striped |

58.

- | | | |
|---------------------|-----------------|---------------|
| 1. brooch | 5. charm | 9. necklace |
| 2. clip ear-ring | 6. ring | 10. pendant |
| 3. pierced ear-ring | 7. wedding ring | 11. tie pin |
| 4. bracelet | 8. signet ring | 12. cufflinks |

59.

- | | | | | | |
|------|------|------|------|------|------|
| 1. d | 2. c | 3. c | 4. a | 5. b | 6. c |
|------|------|------|------|------|------|

60.

- | | | | | |
|------|------|------|------|-------|
| 1. d | 3. c | 5. d | 7. d | 9. a |
| 2. b | 4. d | 6. d | 8. d | 10. c |

61.

- | | |
|-----------------|---------------------------|
| 1 — riding-boot | 5 — moccasin |
| 2 — boot | 6 — sandal |
| 3 — clog | 7 — training shoe/trainer |
| 4 — slipper | 8 — wellington |

* 62.

- | | | | |
|------|------|------|------|
| 1. f | 3. b | 5. e | 7. a |
| 2. h | 4. g | 6. c | 8. d |

63.

- | | |
|---------------|-----------------|
| 1 — eyelet | 5 — lining |
| 2 — tongue | 6 — upper |
| 3 — toe - cap | 7 — shoe - lace |
| 4 — heel | 8 — sole |

64.

- | | | | | | |
|------|------|------|------|-------|-------|
| 1. a | 3. d | 5. d | 7. d | 9. d | 11. c |
| 2. d | 4. d | 6. b | 8. b | 10. c | 12. b |

65.

Shoes and Health

Shoes should be BOUGHT with the idea that they are made to PROTECT and support the FEET. They should be CHOSEN for shape, FIT, and the QUALITY of the material.

SIZE is no guarantee that SHOES will fit, and people should CHOOSE shoes that follow the SHAPE of the foot. Only with PROPERLY fitting shoes will the wearer avoid the PAIN of having the small BONES of the foot pushed out of PLACE.

66.

- | | | |
|---------------|---------------|------------|
| 1 — beret | 5 — helmet | 9 — turban |
| 2 — headscarf | 6 — felt hat | 10 — veil |
| 3 — top hat | 7 — straw hat | |
| 4 — cap | 8 — hood | |

67.

- | | |
|----------------------|------------------------|
| 1. brush; hair brush | 4. dyc |
| 2. comb; comb | 5. bald; wigs |
| 3. rollers | 6. hairdresser; hairdo |

* 68.

- | | | | | |
|------|------|------|------|-------|
| 1. d | 3. c | 5. b | 7. c | 9. c |
| 2. c | 4. b | 6. d | 8. a | 10. c |

69.

- | | | | | |
|------|------|------|------|------|
| 1. d | 2. d | 3. a | 4. c | 5. c |
|------|------|------|------|------|

70.

B				
L	E	M	O	N
A		R		B
C	R	E	A	M
K		N	R	W
		G	R	E
P	A	L	E	D
	Z		B	
P	U	R	P	L
	R		U	
	E		E	

V. Crime and Punishment

* 71.

Crime

Crime violates the laws of a community, STATE, or nation. It is punishable in accordance with these LAWS. The definition of crime varies according to time and place, but the laws of most COUNTRIES consider as crimes such OFFENCES as arson, BIGAMY, burglary, FORGERY, murder, and TREASON.

Not all offences against the law are CRIMES. The laws that set down the punishments for crimes form the CRIMINAL LAW. This law defines as crimes those offences considered most harmful to the COMMUNITY. On the other hand, a PERSON may wrong someone else in some other way that offends the CIVIL law.

The common law recognizes three CLASSES of crime: treason, FELONY, and misdemeanour. Death or LIFE IMPRISONMENT is the usual PENALTY for treason. Laws in the United States, for example, define a felony as a crime that is punishable by a TERM of one year or more in a state of federal PRISON. A person who commits a MISDEMEANOUR may be punished by a FINE or a jail term of less than one year.

72.

- | | | |
|------------------|-----------------|----------------|
| 1. a thief | 5. a shoplifter | 9. a kidnapper |
| 2. a pickpocket | 6. a murderer | 10. a spy |
| 3. a blackmailer | 7. a burglar | 11. a vandal |
| 4. a hijacker | 8. a robber | 12. a bigamist |

73.

- | | | | | |
|------|------|-------|-------|-------|
| 1. b | 5. d | 9. d | 13. d | 17. b |
| 2. c | 6. d | 10. b | 14. b | 18. b |
| 3. b | 7. c | 11. c | 15. c | 19. b |
| 4. b | 8. c | 12. c | 16. c | 20. a |

*74

- | | | | | | |
|------|------|------|------|-------|-------|
| 1. f | 3. k | 5. j | 7. l | 9. i | 11. h |
| 2. g | 4. d | 6. b | 8. e | 10. c | 12. a |

*75.

- | | | | | |
|------|------|------|------|-------|
| 1. d | 3. a | 5. b | 7. b | 9. c |
| 2. b | 4. b | 6. d | 8. c | 10. c |

76.

D F G S P Y V K J D H Y S I E K L M S N B
M N B H I J A C K E R M N H Y S H D L K J
N G V O G H N A W E R T Y U I O P L K J H
I M N P B V D X A S W E R F D F G G H J F
S J H L L O A K K I D N A P P E R S G T A
S N B I U Y L S E R T P I C K P O C K E T
A W E F S D F G H J K L M N C V B S E R H
S A W T E R R E L I A M K C A L B W A S I
S A W E E R T Y G F M U R D E R E R D F E
A A S R W E R T Y U B U R G L A R S D V F

77.

- | | | | | | |
|------|------|-------|-------|-------|-------|
| 1. d | 5. c | 9. b | 13. c | 17. d | 21. d |
| 2. d | 6. b | 10. d | 14. a | 18. c | 22. d |
| 3. a | 7. b | 11. c | 15. b | 19. b | 23. b |
| 4. b | 8. d | 12. b | 16. b | 20. b | 24. b |

78.

If you commit a crime you may be:

suspected — interrogated — accused — arrested — charged — tried — convicted sent to
prison — paroled

79.

- | | | | | |
|------|-------|-------|-------|-------|
| 1. c | 6. d | 11. b | 16. b | 21. b |
| 2. a | 7. c | 12. c | 17. d | 22. a |
| 3. a | 8. c | 13. a | 18. d | 23. c |
| 4. d | 9. a | 14. d | 19. b | 24. d |
| 5. c | 10. a | 15. b | 20. b | 25. c |

80.

- | | | | | |
|------|------|------|------|-------|
| 1. c | 3. b | 5. d | 7. c | 9. b |
| 2. b | 4. b | 6. b | 8. a | 10. c |

*** 81.**

- | | | | | |
|------|------|------|------|-------|
| 1. c | 3. h | 5. i | 7. a | 9. j |
| 2. f | 4. e | 6. b | 8. g | 10. d |

82.

- | | | | | |
|------|------|------|-------|-------|
| 1. c | 4. b | 7. c | 10. b | 13. d |
| 2. a | 5. c | 8. b | 11. c | 14. c |
| 3. b | 6. a | 9. d | 12. c | |

*** 83.**

Trial by Jury

A jury is a selected group of laymen that hears the WITNESSES in LEGAL DISPUTES and decides the facts. A courtroom trial in which a JURY decides the facts is called a TRIAL by jury.

Before each COURT term, a jury commissioner or another public OFFICER prepares a panel, or large initial LIST, of qualified jurors. For each trial, JURORS are selected by lot from this PANEL.

Before the trial begins, the jurors SWEAR to decide the facts fairly. They hear the TESTIMONY given by witnesses for both sides, including CROSS-EXAMINATIONS. Then COUNSEL for each side sum up, or summarize the case, and the JUDGE explains the applicable law in his instructions to the jury.

In CIVIL SUITS for financial damages, the jury must decide who is at FAULT and must determine the amount of MONEY to be paid. In criminal cases, the jury must decide whether or not the ACCUSED is guilty „beyond a reasonable doubt”, and then either return a verdict of guilty, or ACQUIT the defendant by a verdict of not guilty. If the verdict is GUILTY, the judge imposes the SENTENCE, or punishment, within limits that have been fixed by the LEGISLATURE.

*** 84.**

- | | | | | |
|------|------|------|-------|-------|
| 1. b | 4. d | 7. c | 10. c | 13. b |
| 2. c | 5. b | 8. c | 11. b | 14. b |
| 3. c | 6. a | 9. b | 12. d | 15. a |

85.

- | | | | | | |
|------|------|------|------|-------|-------|
| 1. d | 3. b | 5. c | 7. b | 9. d | 11. c |
| 2. d | 4. a | 6. d | 8. c | 10. a | 12. c |

VI. Education

86.

- | | | | | |
|------|-------|-------|-------|-------|
| 1. a | 6. c | 11. c | 16. d | 21. c |
| 2. c | 7. a | 12. d | 17. d | 22. b |
| 3. a | 8. a | 13. c | 18. d | 23. d |
| 4. d | 9. b | 14. c | 19. d | 24. b |
| 5. c | 10. b | 15. c | 20. a | 25. c |

87.

- | | | | | |
|-------|-------|-------|-------|-------|
| 1. a | 6. a | 11. c | 16. a | 21. c |
| 2. b | 7. d | 12. d | 17. a | 22. b |
| 3. b | 8. b | 13. c | 18. c | 23. b |
| 4. b. | 9. a | 14. b | 19. c | 24. a |
| 5. c | 10. a | 15. c | 20. a | 25. b |

* 88.

Selecting Courses

The courses given by a COLLEGE or university are called its curriculum. The PROSPECTUS of the institution OUTLINES the complete CURRICULUM. It gives the REQUIREMENTS for entry to each course, as well as the credits given for the COURSE.

Each course is designated as giving a SPECIFIED number of credits. These are usually equal to the number of CLASS HOURS devoted each week to the course. For example, a course that meets three times a WEEK usually gives THREE credits towards graduation. Schools using the semester CALENDAR require about 120 credits for GRADUATION. Between 30 and 40 of the required CREDITS must be in the student's MAJOR subject.

Schools vary considerably in the AMOUNT of freedom given students in SELECTING their courses. Almost all schools have a certain NUMBER of required SUBJECTS. Students can also usually choose nonrequired courses called ELECTIVES. Liberal-arts colleges usually give students more OPPORTUNITY to choose than do TECHNICAL schools.

* 89.

- | | | | |
|------|------|------|-------|
| 1. d | 4. d | 7. b | 10. a |
| 2. b | 5. a | 8. a | 11. c |
| 3. d | 6. b | 9. c | 12. c |

90.

- | | | | | |
|------|------|------|-------|-------|
| 1. c | 4. b | 7. c | 10. a | 13. c |
| 2. b | 5. d | 8. a | 11. c | 14. c |
| 3. b | 6. a | 9. b | 12. c | 15. d |

* 91.

- | | | | |
|------|-------|-------|-------|
| 1. c | 6. b | 11. c | 16. b |
| 2. b | 7. a | 12. d | 17. c |
| 3. b | 8. d | 13. c | 18. c |
| 4. b | 9. d | 14. a | |
| 5. a | 10. b | 15. b | |

92.

- | | | | | |
|------|-------|-------|-------|-------|
| 1. c | 6. b | 11. c | 16. a | 21. d |
| 2. a | 7. a | 12. b | 17. a | 22. a |
| 3. b | 8. c | 13. a | 18. b | 23. a |
| 4. b | 9. d | 14. b | 19. c | 24. c |
| 5. b | 10. a | 15. b | 20. c | 25. c |

* 93.

- | | | | | |
|------|------|-------|-------|-------|
| 1. b | 5. d | 9. d | 13. b | 17. a |
| 2. a | 6. d | 10. b | 14. c | 18. b |
| 3. c | 7. d | 11. d | 15. a | |
| 4. b | 8. c | 12. b | 16. a | |

94.

- | | | | | |
|------|------|-------|-------|-------|
| 1. b | 5. b | 9. a | 13. c | 17. a |
| 2. c | 6. c | 10. c | 14. c | 18. d |
| 3. d | 7. c | 11. b | 15. c | 19. d |
| 4. a | 8. a | 12. d | 16. d | 20. b |

95.

Students

The student body of a UNIVERSITY or college is divided into GRADUATES and undergraduates. Graduates have already received their BACHELOR'S degrees, while UNDERGRADUATES have not. The undergraduates belong to one of four CLASSES, according to their YEAR of study. These are FRESHMEN, sophomore, JUNIOR, and senior classes. Most schools also admit SPECIAL students who take a number of COURSES, but are not working towards a DEGREE.

Student BODIES vary considerably from SCHOOL to school. Some institutions are CO-EDUCATIONAL, with both men and WOMEN students. Others admit STUDENTS of only one SEX.

A CO-ORDINATE institution has SEPARATE men's and women's colleges. They are controlled by the same central AUTHORITY and are usually LOCATED on the same campus or nearby CAMPUSES.

* 96.

- | | | | | | |
|------|------|------|------|-------|-------|
| 1. d | 3. a | 5. d | 7. a | 9. c | 11. a |
| 2. d | 4. c | 6. c | 8. c | 10. d | 12. a |

97.

- | | | | | |
|------|------|------|-------|-------|
| 1. i | 4. e | 7. f | 10. g | 13. k |
| 2. h | 5. m | 8. d | 11. c | |
| 3. b | 6. a | 9. j | 12. l | |

98.

- | | | | | | |
|------|------|------|------|-------|-------|
| 1. b | 3. c | 5. b | 7. b | 9. d | 11. c |
| 2. c | 4. a | 6. d | 8. d | 10. c | 12. d |

99.

1. Animals are often GUIDED by their instinct as to what is the right thing to do in a difficult situation.
2. German shepherd dogs are sometimes TRAINED to GUIDE the blind.
3. Prof. Wise LECTURES on British history twice a week. He has already TAUGHT us a lot. We LEARNED from him how to read and evaluate original documents.
4. Mr Needle INSTRUCTS/TEACHES a class of apprentices in sewing. He INSTRUCTS apprentices about types of cloth and they are TAUGHT/TRAINED to cut out and sew garments.

* 100.

- | | | | | | |
|------|------|------|------|-------|-------|
| 1. a | 3. c | 5. d | 7. d | 9. a | 11. b |
| 2. b | 4. d | 6. a | 8. a | 10. c | 12. a |

** 101.

- | | | | | | |
|------|------|------|------|-------|-------|
| 1. c | 3. b | 5. a | 7. c | 9. a | 11. a |
| 2. b | 4. a | 6. a | 8. b | 10. b | 12. b |

** 102.

SUBJECT	TEACHER	IS THE STUDY OF
geology	GEOLOGIST	ROCKS
theology	THEOLOGIAN	religion
BOTANY	botanist	PLANTS
archeology	ARCHEOLOGIST	ancient ruins
ENTOMOLOGY	entomologist	INSECTS
agronomy	AGRONOMIST	FARMING
BIOLOGY	BIOLOGIST	life
zoology	ZOOLOGIST	ANIMAL KINGDOM
METEOROLOGY	meteorologist	WEATHER
etymology	ETYMOLOGIST	words
embryology	EMBRYOLOGIST	unborn babies
GRAPHOLOGY	graphologist	HANDWRITING

103.

- | | | | | |
|------|-------|-------|-------|-------|
| 1. d | 6. c | 11. c | 16. c | 21. c |
| 2. d | 7. c | 12. c | 17. d | 22. c |
| 3. c | 8. a | 13. c | 18. b | 23. a |
| 4. c | 9. b | 14. c | 19. c | 24. c |
| 5. a | 10. a | 15. a | 20. a | 25. b |

104.

Grading

Grading is a METHOD used in schools to RECORD student achievements. Almost every SCHOOL keeps a record of each student's ACHIEVEMENTS in order to have some basis for measuring his PROGRESS. The record supplies information for REPORTS to parents. Universities and COLLEGES often use this information to help determine whether they should ADMIT a student.

For a long time, the most COMMON method of recording achievement was by PERCENTAGE, with a mark, or GRADE, of 100 per cent representing PERFECT achievement. The MINIMUM mark for a PASS as usually 70 per cent, and for AVERAGE work, about 80 per cent. Today, the letters A, B, C, D, E, and OCCASIONALLY F, are much more commonly used. The mark A stands for exceptional achievement, and E or F means FAILURE.

A few schools use no MARKING system at all. Instead, each TEACHER writes a detailed LETTER to the parents. Such letters report the student's progress, ATTITUDE, activities, and social ADJUSTMENT.

105.

- | | | | | |
|------|------|------|-------|-------|
| 1. d | 4. d | 7. d | 10. b | 13. a |
| 2. a | 5. a | 8. c | 11. b | 14. c |
| 3. d | 6. b | 9. a | 12. c | 15. a |

* 106.

- | | | | | |
|------|------|-------|-------|-------|
| 1. d | 5. a | 9. a | 13. c | 17. c |
| 2. b | 6. b | 10. a | 14. c | 18. a |
| 3. b | 7. a | 11. a | 15. a | |
| 4. c | 8. d | 12. b | 16. c | |

107.

- | | | | | | |
|------|------|-------|-------|-------|-------|
| 1. d | 5. b | 9. d | 13. b | 17. b | 21. d |
| 2. c | 6. c | 10. b | 14. c | 18. a | 22. a |
| 3. c | 7. b | 11. b | 15. c | 19. a | |
| 4. a | 8. b | 12. b | 16. b | 20. c | |

* 108.

- | | | | | |
|------|------|------|------|-------|
| 1. a | 3. a | 5. c | 7. a | 9. a |
| 2. a | 4. c | 6. b | 8. b | 10. a |

109.

- | | | | | | | | | |
|----|---|---|---|---|---|---|---|---|
| 1 | | D | I | A | L | E | C | T |
| 2 | T | O | N | G | U | E | | |
| 3 | | | S | A | R | C | A | S |
| 4 | P | R | O | V | E | R | B | |
| 5 | | | S | Y | N | O | N | Y |
| 6 | | | | C | L | I | C | H |
| 7 | P | R | O | N | U | N | C | I |
| 8 | | | A | N | T | O | N | Y |
| 9 | | | S | L | A | N | G | |
| 10 | V | O | C | A | B | U | L | A |
| 11 | | | | A | C | C | E | N |
| 12 | | | J | A | R | G | O | N |
| 13 | | | S | E | N | T | E | N |
| 14 | I | D | I | O | M | S | | |

** 110.

- | | | |
|--------------------|-----------------|-------------------|
| a) full stop | f) stroke | k) capital letter |
| b) abbreviation | g) bracket | l) colon |
| c) inverted commas | h) small letter | m) question mark |
| d) comma | i) hyphen | n) apostrophe |
| e) italics | j) asterisk | |

111.

- | | | | | |
|------|------|------|------|-------|
| 1. b | 3. d | 5. a | 7. b | 9. c |
| 2. b | 4. b | 6. b | 8. c | 10. d |

* 112.

Payment Plans

Tuition FEES are payable in ADVANCE in full at the time billed. Students may pay by CASH, cheque, MONEY order or CREDIT card (Master Card or VISA). Foreign students must pay in British CURRENCY.

PAYMENT may be made by telephone for credit card HOLDERS. Payment may also be by MAIL. However, the College is not responsible for lost or DELAYED mail.

Students who do not pay in FULL in advance automatically choose the deferred payment plan of two equal INSTALMENTS. The initial payment is due APPROXIMATELY two weeks prior to the BEGINNING of each term. The BALANCE is due four weeks after the beginning of the term.

113.

- | | | | | |
|------------------|------------------|-----------|--------------|----------------------|
| 1. ballpoint pen | 3. tape recorder | 5. ruler | 7. paperclip | 9. pocket calculator |
| 2. typewriter | 4. scissors | 6. rubber | 8. chalk | 10. pencil |

114.

- | | | |
|------------------|------------------------|-------------|
| 1 — hole punch | 4 — drawing pin | 7 — file |
| 2 — screen | 5 — felt-tip pen | 8 — stapler |
| 3 — board duster | 6 — overhead projector | |

115.

- | | | | | |
|------|------|------|-------|-------|
| 1. d | 4. d | 7. c | 10. b | 13. a |
| 2. c | 5. a | 8. c | 11. d | 14. c |
| 3. b | 6. c | 9. c | 12. c | 15. c |

116.

- | | | | | |
|------|------|------|------|-------|
| 1. a | 3. b | 5. a | 7. a | 9. d |
| 2. b | 4. b | 6. b | 8. b | 10. b |

VII. Food, Cooking and Restaurants

117.

Food

Food is one of our most important DAILY needs. It gives us ENERGY to work and PLAY. It makes us grow, and keeps our bodies strong and HEALTHY. Without food, we DIE. All living things — plants, ANIMALS and man — need food to live and GROW. But only PLANTS make their own food. They also provide food for animals and MAN.

Customs influence the ways PEOPLE eat. Most Americans and EUROPEANS eat from individual PLATES, using KNIVES/SPOONS, forks, and SPOONS/KNIVES. Arabs use only their LEFT hands to spoon foods from a central BOWL. Chinese and Japanese use CHOPSTICKS to pick up food from a small bowl held close to the MOUTH.

118.

- | | | | | | |
|------|------|------|-------|-------|-------|
| 1. a | 4. a | 7. d | 10. d | 13. c | 16. b |
| 2. c | 5. b | 8. c | 11. c | 14. d | 17. c |
| 3. d | 6. b | 9. b | 12. d | 15. b | 18. c |

119.

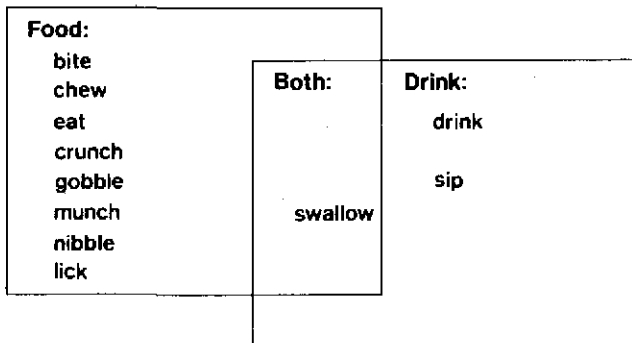

120.

- | | | | | |
|------|------|-------|-------|-------|
| 1. b | 5. d | 9. a | 13. c | 17. b |
| 2. d | 6. a | 10. c | 14. c | 18. d |
| 3. c | 7. b | 11. d | 15. b | 19. c |
| 4. a | 8. a | 12. c | 16. a | 20. b |

**** 121.**

- | | | | |
|------------|-----------|------------|----------|
| 1 — barley | 2 — maize | 4 — millet | 3 — oats |
| 6 — rice | 7 — rye | 5 — wheat | |

*** 122.**

- | | | | | |
|------|------|------|-------|-------|
| 1. a | 4. c | 7. c | 10. c | 13. a |
| 2. b | 5. c | 8. b | 11. b | 14. a |
| 3. d | 6. b | 9. d | 12. c | |

**** 123.**

- Cereals: barley, flour, maize, rice, rye, wheat
- Dairy products: cream, yoghurt
- Fish: herring, plaice, salmon, sole, trout
- Fruit: blackberry, gooseberry, grape, pear
- Herbs: basil, dill, mint, mustard, parsley, sage, thyme
- Meat: bacon, chicken, lamb, mutton, rabbit, sausage, veal
- Vegetables: aubergine, beans, onions, peas

124.

- | | | | | |
|------|------|-------|-------|-------|
| 1. c | 5. d | 9. d | 13. c | 17. a |
| 2. a | 6. c | 10. d | 14. d | 18. c |
| 3. c | 7. d | 11. a | 15. d | 19. d |
| 4. d | 8. c | 12. c | 16. c | |

**** 125.**

- Artichoke, chicory, marrow and turnip are not herbs.
- Horseradish and vinegar are not spices.
- Macaroons and pies are not pasta.
- Boar is not poultry.
- Cockerel, kipper and prunes are not shellfish.
- Barley and maize are not game.
- Deer are not fish.
- Ginger beer and squash are not alcoholic drinks.
- Sandwich, snack and refreshments are not kinds of meals.
- Bourbon, liqueur and shandy are not kinds of wine.

126.**Meals**

Most people eat three MEALS a day — breakfast, LUNCH and dinner. Some eat a fourth meal, SUPPER, late at night. ENGLISH tradition provides an extra light meal served in the late AFTERNOON. Its basic MENU usually includes tea and special tea cakes or cucumber sandwiches.

Meals vary in different countries. BREAKFAST in the United States may include fruit or fruit JUICE, coffee, toast and a choice of cereal, or BACON and eggs. Many people like pancakes with maple SYRUP for breakfast. CONTINENTAL Europeans sometimes have an early breakfast of ROLLS and coffee or hot CHOCOLATE, and eat a SECOND breakfast later on in the MORNING.

*** 127.**

1. c	3. b	5. a	7. c	9. c	11. c
2. d	4. b	6. c	8. c	10. c	12. b

*** 128.**

2 colander	3 — cruet	4 — funnel	5 — ladle
1 — skimmer	7 — sieve	8 — soup tureen	6 — whisk

129.

1. b	5. c	9. b	13. a	17. a
2. c	6. d	10. b	14. a	18. a
3. a	7. d	11. d	15. b	19. d
4. c	8. c	12. c	16. c	20. a

130.

1. kettle	5. plate rack	9. sugar bowl
2. mincer	6. rolling-pin	10. pepperpot
3. grater	7. frying pan	11. nutcracker
4. kitchen scales	8. corkscrew	12. can/tin opener

131.

1. c	3. a	5. b	7. b	9. c	11. d
2. b	4. d	6. a	8. d	10. c	12. c

**** 132.**

1. c	4. b	7. a	10. c	13. c
2. a	5. c	8. b	11. a	14. c
3. c	6. c	9. b	12. a	15. a

133.

1. a	5. c	9. b	13. c	17. c
2. c	6. b	10. a	14. b	18. b
3. a	7. d	11. a	15. b	19. b
4. c	8. c	12. a	16. a	20. d

134.

1. f	3. b	5. g	7. a
2. h	4. e	6. d	8. c

135.

1. a	3. a	5. d	7. a	9. c	11. c
2. c	4. c	6. d	8. a	10. c	12. a

*** 136.**

1. a	4. d	7. c	10. d	13. d	16. b
2. b	5. b	8. c	11. b	14. b	17. d
3. a	6. c	9. c	12. d	15. c	

**** 137.**

- A. Cream: whip
- B. Eggs: beat, crack, poach, scramble, shell, whisk
- C. Fish: bone, poach, steam
- D. Meat: baste, bone, braise, carve, chop, dice, mince, stew
- E. Pastry: knead, roll
- F. Vegetables: chop, dice, grate, peel, shred, steam

*** 138.**

- | | | | | |
|------|------|------|-------|-------|
| 1. b | 4. b | 7. c | 10. a | 13. a |
| 2. c | 5. b | 8. b | 11. a | 14. a |
| 3. c | 6. a | 9. b | 12. d | 15. b |

139.

- | | |
|----------------------------|---------------------------|
| 1. brussels sprouts; leeks | 6. tin; oven |
| 2. boil; kettle | 7. mix; flour; bowl/basin |
| 3. raw | 8. ingredients; herbs |
| 4. peel | 9. course; appetizer |
| 5. cuisine/cooking; hot | |

140.

- | | | | | | | |
|------|------|------|-------|-------|-------|------|
| 1. d | 4. b | 7. c | 10. c | 13. b | 16. b | 19.d |
| 2. a | 5. a | 8. a | 11. c | 14. c | 17. d | |
| 3. d | 6. c | 9. a | 12. a | 15. d | 18. b | |

141.

- | | | | | |
|------|------|------|------|-------|
| 1. b | 3. b | 5. d | 7. c | 9. c |
| 2. c | 4. c | 6. d | 8. a | 10. a |

*** 142.**

MENU:

- I. APPETIZERS: cheese dip tray
avocado vinaigrette
prawn cocktail
- II. SOUPS: cream of mushroom
- III. MAIN DISHES: a) m e a t s:
pork chops
game pie
grilled veal fillet
sparcibs
beef Wellington
roast beef and Yorkshire pudding
- b) p o u l t r y:
roast duckling
turkey
- c) f i s h:
Creole haddock
fried fillet of plaice
sole in white wine sauce

IV. SIDE DISHES: apple sauce
 blue cheese salad dressing
 butter
 dumpling
 grilled tomatoes
 tossed green salad

V. BEVERAGES: coffee
 hot chocolate

VI. SWEETS: apple pie
 spice cake
 fruit salad
 hot fudge sundae
 peach melba

VII. CHEESE: Camembert
 Emmentaler
 farmhouse cheddar

*** 143.**

1. d 3. a 5. a 7. a
 2. a 4. b 6. a 8. b

144.

1. lose 4. especially 7. pour 10. smell
 2. bottom 5. yolk 8. cheque 11. served; strong
 3. yeast 6. sharp 9. hot

145.

C H O P S T I C K S P E A S
 R N I C A I P
 O I P E E L U E O
 C H O P C C O
 K N W R A R E C O R N
 E A E P H
 R O A S T A A E G
 Y P E M K N I F E R
 P O R K E A
 L I N G R E D I E N T
 B E E F D G E

VIII. Gardening

146.

1. b 5. c 9. b 13. a 17. d
 2. a 6. d 10. c 14. c 18. a
 3. d 7. b 11. c 15. a 19. c
 4. d 8. b 12. a 16. b

* 147.

- | | | | | |
|------|------|-------|-------|-------|
| 1. a | 5. c | 9. b | 13. b | 17. d |
| 2. b | 6. d | 10. d | 14. c | 18. c |
| 3. a | 7. d | 11. b | 15. b | 19. c |
| 4. a | 8. d | 12. d | 16. d | 20. a |

148.

- | | | | |
|------------|------------|---------------|-----------|
| 8 — fork | 4 — hoe | 3 — lawnmower | 1 — rake |
| 2 — scythe | 5 — shears | 6 — sickle | 7 — spade |

149.

- | | | |
|----------|-------------|------------|
| 1. dirty | 3. flower | 5. grow |
| 2. area | 4. orchards | 6. digging |

150.

- | | | |
|--------------|------------------|-------------|
| 1. violet | 3. gladioli | 5. daisy |
| 2. carnation | 4. forget-me-not | 6. daffodil |

151.

- | | | | | |
|------|------|------|------|-------|
| 1. a | 3. c | 5. d | 7. b | 9. a |
| 2. c | 4. c | 6. b | 8. b | 10. c |

152.

Flowers

The word *flower* may MEAN either 1) the blossom or 2) the whole plant. BOTANISTS use the word *flower* to mean only the BLOSSOM of a plant. They call the plant — blossom, STEM/ROOTS, leaves, and ROOTS/STEM — a flowering plant.

Any plant that PRODUCES some sort of flower, even a tiny, COLOURLESS one, is a flowering plant. Grasses, ROSES, lilies, APPLE trees, and oaks are all flowering plants.

Flowers are the REPRODUCTIVE part of FLOWERING plants. The plant could not develop SEEDS and reproduce without them. MAN depends completely on flowers and flowering plants for his FOOD. Flowering plants INCLUDE almost all of our GRAINS, fruits, and VEGETABLES. Even the ANIMALS that we use for food, such as CATTLE/SHEEP, pigs, and SHEEP/CATTLE, live on flowering plants.

153.

- | | | | | |
|--------------|------------|---------------|---------------|-----------|
| 1. brukselka | 3. czosnek | 5. por | 7. papryka | 9. rzepa |
| 2. oberżyna | 4. chrzan | 6. pietruszka | 8. rzodkiewka | 10. arbuz |

154.

Vegetables

We EAT vegetables every day, yet it is very DIFFICULT to say exactly what we MEAN by the word *vegetable*. Sometimes the word is used in the phrase “the vegetable KINGDOM”, which means very much the same thing as the ENTIRE world of plants.

According to another meaning, vegetables are FOODS that we obtain from the leaves, flowers, or ROOTS of plants.

Vegetables are usually eaten without first being PROCESSED or milled as CEREAL grains such as wheat and OATS are.

Vegetables are also considered different from FRUITS. Fruits generally may be eaten RAW just as they COME from the PLANTS, while vegetables are more often COOKED. But even this rule is not absolute.

IX. Health and Medicine

155.

- | | | | | | |
|-------------|------------|-----------|------------|----------|----------|
| 1. hair | 3. eyebrow | 5. eyelid | 7. nostril | 9. lip | 11. jaw |
| 2. forehead | 4. eyelash | 6. cheek | 8. mouth | 10. chin | 12. neck |

156.

- | | | | |
|----------------|-----------|-------------|----------|
| 1 abdomen | 7 bottom | 13 forearm | 19 heel |
| 2 Adam's apple | 8 palm | 14 biceps | 20 ankle |
| 3 throat | 9 wrist | 15 shoulder | 21 thigh |
| 4 breast | 10 thumb | 16 toe | 22 groin |
| 5 nipple | 11 armpit | 17 knee | 23 navel |
| 6 waist | 12 elbow | 18 calf | 24 hip |

* 157.

- | | | | | |
|------|------|------|------|-------|
| 1. c | 3. a | 5. c | 7. a | 9. a |
| 2. b | 4. a | 6. b | 8. d | 10. b |

158.

- | | | |
|----------|------------|------------|
| 1. heart | 3. lungs | 5. stomach |
| 2. liver | 4. kidneys | 6. bladder |

** 159.

- | | | | | |
|------|------|------|------|-------|
| 1. f | 3. j | 5. c | 7. d | 9. g |
| 2. e | 4. a | 6. i | 8. b | 10. h |

160.

- | | | | | | |
|------|------|------|------|-------|-------|
| 1. f | 3. h | 5. a | 7. k | 9. e | 11. g |
| 2. i | 4. l | 6. b | 8. c | 10. d | 12. j |

161.

- | | | | | |
|------|------|------|------|-------|
| 1. c | 3. c | 5. d | 7. c | 9. c |
| 2. d | 4. a | 6. c | 8. c | 10. c |

* 162.

- | | | | | |
|------------------|------------|----------|-----------|-------------|
| 1. fingers, toes | 3. stomach | 5. wrist | 7. tongue | 9. forehead |
| 2. blood | 4. gum | 6. ribs | 8. brain | 10. foot |

163.

B R E A S T A N E
 L O A R T E R Y
 A B D O M E N M R E
 D V
 D E N T A L C H E S T
 E A
 R I B P A L M L
 L V U F N I
 S O L E P O V
 O I R I S S E
 L I D N L E A R

* 164.

- | | |
|-----------------------------------|--------------|
| 1. eyes | 6. tongue |
| 2. teeth | 7. finger |
| 3. arms, legs, fingers, (oneself) | 8. shoulders |
| 4. arms | 9. fingers |
| 5. head | 10. feet |

165.

- | | | | | |
|------|------|------|-------|-------|
| 1. d | 4. d | 7. d | 10. a | 13. d |
| 2. d | 5. d | 8. b | 11. c | 14. d |
| 3. b | 6. d | 9. c | 12. c | 15. a |

* 166.

General Dental Practice

General dental PRACTICE includes mouth examination, diagnosis, treatment, and prevention of DISEASE. The DENTIST frequently uses X-rays and other EQUIPMENT to ensure correct diagnosis and TREATMENT.

Treatment may include filling CAVITIES, removing the NERVES of teeth, treating diseases of the GUMS, removing TEETH, and replacing LOST teeth with bridges and DENTURES. Anesthesia is often used in any treatment that might cause PAIN. Teeth may be FILLED with amalgam, or CEMENT.

Perhaps one of the most important parts of a dentist's work is PREVENTIVE dentistry. If a dentist EXAMINES patient's teeth at regular INTERVALS, he may find and TREAT a disease before it becomes serious.

167.

- | | | | | |
|------|------|------|------|-------|
| 1. d | 3. c | 5. b | 7. d | 9. d |
| 2. c | 4. c | 6. c | 8. a | 10. d |

* 168.

Special Diets

Certain groups of PEOPLE, such as young children or older people, have special DIETARY needs. Because CHILDREN grow RAPIDLY, they need food not only to replace worn-out tissues and provide ENERGY, but also to build new TISSUE.

A child's diet should INCLUDE milk PRODUCTS, eggs, LEAN meat, poultry, fish, fruits, vegetables, and cereals.

A WELL-BALANCED diet is important to the older PERSON as it is to the child. Older people need as many NUTRIENTS as young adults. But if their ACTIVITY is reduced, they will need fewer calories. Expectant or NURSING mothers and babies also need special diets.

* 169.

- | | | | |
|------|------|------|------|
| 1. b | 3. c | 5. b | 7. a |
| 2. a | 4. b | 6. b | 8. b |

** 170.

- | | |
|------------------------------------|----------------------|
| 1. zapalenie wyrostka robaczkowego | 7. zapalenie wątroby |
| 2. zapalenie oskrzeli | 8. grypa |
| 3. rak | 9. białaczka |
| 4. ospa wietrzna | 10. odra |
| 5. cukrzyca | 11. zapalenie płuc |
| 6. katar sienny | 12. gruźlica |

171.

- | | | | | |
|------|-------|-------|-------|-------|
| 1. c | 6. c | 11. d | 16. b | 21. c |
| 2. b | 7. d | 12. a | 17. c | 22. d |
| 3. a | 8. d | 13. b | 18. d | 23. a |
| 4. b | 9. c | 14. c | 19. a | 24. b |
| 5. a | 10. a | 15. d | 20. d | 25. a |

172.

- | | | | | | |
|-------------|----------------|---------------|--------------|------------|-------------|
| 1. suffers | 3. distinguish | 5. bad | 7. cases | 9. throat | 11. mild |
| 2. pregnant | 4. sneezing | 6. infectious | 8. diagnosed | 10. caught | 12. anxious |

** 173.

- | | | | | |
|------|------|------|------|-------|
| 1. c | 3. d | 5. j | 7. h | 9. g |
| 2. a | 4. i | 6. f | 8. e | 10. b |

** 174.

- | | | | | | |
|------|------|------|------|-------|-------|
| 1. c | 3. a | 5. a | 7. a | 9. c | 11. d |
| 2. a | 4. d | 6. b | 8. d | 10. a | 12. b |

175.

How the Body Fights Disease

The SKIN is often called "the body's first LINE of defence". It acts as armour, resisting many germs that might harm the more DELICATE parts of the BODY. Any BREAK in the skin, even a pin PRICK, provides an opening for DANGEROUS germs. Some GERMS/BACTERIA enter the body through the NOSE/MOUTH and MOUTH/NOSE and other natural openings. These areas provide warmth and MOISTURE, in which germs thrive. When the MEMBRANE of the nose and throat becomes irritated, we cough or SNEEZE, blowing out the unwanted substances.

Other body LIQUIDS also provide a defence against DISEASE. Tears, for example, wash BACTERIA/GERMS from the EYES. Tears also contain substances that fight bacteria. Acid in the STOMACH kills many germs before they can reach other PARTS of the body.

176.

1. Taken by mouth: capsules, gargle, lozenge, pill, tablet
2. Injected into the body: serum, vaccines
3. Applied to the body surface: cream, jelly, lotion, ointment, powder

177.

- | | | | | |
|------|------|-------|-------|-------|
| 1. a | 5. c | 9. c | 13. b | 17. c |
| 2. a | 6. a | 10. a | 14. d | 18. a |
| 3. d | 7. d | 11. d | 15. c | 19. a |
| 4. a | 8. d | 12. b | 16. d | 20. c |

* 178.

Treatment of a Minor Injury

CLEANSE the wound thoroughly and apply an ANTISEPTIC to counteract germs which spread DISEASE. Otherwise the wound may FESTER. Sticking PLASTER may be applied or the WOUND may be bandaged. OINTMENT may be smeared over the SKIN.

* 179.

- | | | | | | |
|------|------|------|------|-------|-------|
| 1. d | 3. d | 5. d | 7. b | 9. a | 11. c |
| 2. a | 4. c | 6. b | 8. a | 10. c | 12. b |

* 180.

Drugs That Prevent Disease

Doctors use two main types of drugs for the PREVENTION of disease:

1. Vaccines contain dead or HARMLESS germs. They cause the body to develop SUBSTANCES called ANTIBODIES that act to PREVENT disease. DOCTORS ADMINISTER VACCINES before a person has been exposed to such DISEASES as poliomyelitis or SMALLPOX. Vaccines are usually INJECTED but sometimes are given ORALLY.

2. Scrums contain antibodies that FIGHT off the germs of certain diseases, INCLUDING scarlet fever and lockjaw. These drugs are given AFTER a person has been exposed to the disease, or after SYMPTOMS of the disease have appeared. SERUMS are GENERALLY administered by injection.

181.

- | | | | | | |
|------|------|------|------|-------|-------|
| 1. b | 3. b | 5. b | 7. d | 9. b | 11. d |
| 2. c | 4. a | 6. c | 8. a | 10. c | 12. d |

** 182.

Pimafucort Presentations

The DIFFERENT presentations of Pimafucort are especially adapted to the NATURE of various skin CONDITIONS. For treatment of ACUTE and subacute skin disorders and in the treatment of DISORDERS of the hairy PARTS of the skin, and those localized in the skin FOLDS, Pimafucort LOTION/CREAM and Pimafucort CREAM/LOTION should be used, whereas in the TREATMENT of chronic disorders of the skin with desquamations, dry or fissured skin lesions, Pimafucort ointment will be APPLIED. For acute, very moist skin disorders it may be NECESSARY to use Pimafucort cream or Pimafucort lotion with a COMPRESS. In some CASES an "alternating treatment" may be indicated, e.g. in intertriginous eczema (in this instance Pimafucort OINTMENT softens the SKIN too much, whereas the cream and lotion dehydrate it too STRONGLY).

* 183.

- | | | | | | |
|------|------|------|------|-------|-------|
| 1. a | 3. a | 5. c | 7. b | 9. b | 11. d |
| 2. b | 4. c | 6. a | 8. d | 10. a | 12. d |

184.

- | | | | | | | |
|------|------|------|-------|-------|-------|-------|
| 1. d | 4. a | 7. d | 10. c | 13. c | 16. c | 19. d |
| 2. a | 5. d | 8. b | 11. a | 14. c | 17. c | 20. d |
| 3. c | 6. d | 9. c | 12. b | 15. c | 18. c | |

185.

- | | | | |
|------|------|------|------|
| 1. c | 3. d | 5. e | 7. a |
| 2. g | 4. h | 6. f | 8. b |

186.

- | | | | | |
|------|------|-------|-------|-------|
| 1. b | 5. a | 9. b | 13. a | 17. c |
| 2. a | 6. d | 10. c | 14. b | 18. d |
| 3. c | 7. c | 11. b | 15. b | 19. c |
| 4. c | 8. d | 12. d | 16. a | |

*** 187.**

- | | | | | | |
|------|------|------|------|-------|-------|
| 1. c | 3. d | 5. b | 7. d | 9. a | 11. a |
| 2. c | 4. b | 6. c | 8. b | 10. c | 12. a |

188.

My wife complained that something was wrong WITH her. She said she had a pain IN her back and that she suffered FROM bad headaches. As she was getting worse and worse I sent FOR a doctor. Immediately afterwards she was taken TO hospital. Yesterday she was operated ON. Now she feels much better.

189.

- | | | | |
|-------------|---------------|------------------|-----------------|
| 1. sneezing | 6. artificial | 11. balance | 16. temperature |
| 2. contains | 7. object | 12. prescription | 17. diet |
| 3. cure | 8. chart | 13. afterwards | 18. surgery |
| 4. cancel | 9. effect | 14. sick | 19. thermometer |
| 5. surgeon | 10. patients | 15. fee | 20. exercise |

*** 190.**

- | | | | | | | | | | |
|------|------|------|------|-------|-------|-------|-------|-------|-------|
| 1. a | 3. c | 5. c | 7. b | 9. d | 11. c | 13. c | 15. a | 17. d | 19. a |
| 2. a | 4. b | 6. b | 8. a | 10. a | 12. c | 14. b | 16. b | 18. a | 20. a |

191.

- | | | |
|---------------|-------------|---------------|
| 1. improving | 5. devote | 9. dressing |
| 2. bears | 6. rescued | 10. swollen |
| 3. remain | 7. drill | 11. ambulance |
| 4. spectacles | 8. lozenges | 12. cure |

*** 192.**

- | | | | | |
|------|------|------|------|------|
| 1. g | 3. c | 5. d | 7. h | 9. i |
| 2. b | 4. f | 6. a | 8. e | |

*** 193.**

- | | | | | |
|------|------|------|------|-------|
| 1. b | 3. b | 5. a | 7. a | 9. c |
| 2. c | 4. b | 6. b | 8. b | 10. a |

*** 194.**

		S	C	A	R	C			
		W				O			
	S	E	B			R			
	C	H	I	L	B	L	A	I	N
	R			L		I			
	A			I	S	P	O	T	
B	I	T	E	N	T				
	C			G	E				
	H			G	R	A	Z	E	

195.

- | | | | | |
|------|------|-------|-------|-------|
| 1. c | 5. a | 9. c | 13. d | 17. c |
| 2. c | 6. d | 10. a | 14. c | 18. d |
| 3. d | 7. b | 11. d | 15. d | 19. b |
| 4. d | 8. b | 12. d | 16. c | 20. d |

*** 196.**

1. c 3. d 5. d 7. b 9. b
2. a 4. a 6. c 8. d 10. c

197.

1. a 3. b 5. d 7. b 9. a 11. d
2. b 4. a 6. d 8. a 10. c 12. a

*** 198.**

1. a 3. c 5. d 7. c 9. d 11. c
2. b 4. b 6. a 8. b 10. c

199.

1. c 6. a 11. d 16. b 21. a
2. b 7. d 12. d 17. c 22. a
3. c 8. d 13. a 18. c 23. c
4. b 9. b 14. d 19. a 24. a
5. d 10. c 15. d 20. c 25. b

*** 200.**

1. c 3. a 5. d 7. b
2. c 4. a 6. d 8. b

*** 201.**

1. c 3. d 5. c 7. c 9. c 11. d
2. d 4. b 6. b 8. a 10. b 12. b

202.

1. c 4. d 7. b 10. d 13. a
2. d 5. c 8. c 11. a 14. c
3. c 6. c 9. d 12. a 15. b

203.

1. g 3. i 5. b 7. c 9. e
2. h 4. a 6. d 8. f

204.

1. general practitioner 3. in-patient 5. surgeon 7. midwife
2. nurse 4. out-patient 6. casualty 8. specialist

**** 205.**

1. b 4. a 7. b 10. b 13. b
2. b 5. c 8. c 11. a
3. a 6. b 9. c 12. c

**** 206.**

1. oculist 5. optometrist 9. geriatrician
2. pediatrician 6. dermatologist 10. orthopaedist
3. optician 7. psychiatrist 11. psychoanalyst
4. obstetrician 8. surgeon 12. gynaecologist

**** 207.**

Both of them deal with mental disorders. But the psychiatrist treats mental diseases in general, while the psychoanalyst bases his practice largely upon the method developed by Sigmund Freud. He specializes in analyzing the patient's dreams and in helping him to discover his unconscious memories and repressed desires in order to resolve his mental conflicts. The psychoanalyst, therefore, confines his practice to one branch of psychiatric treatment.

208.

1. f 2. c 3. c 4. d 5. b 6. i 7. g 8. a 9. h

**** 209.**

1. e 5. o 9. r 13. t 17. h
 2. n 6. d 10. f 14. j 18. g
 3. a 7. c 11. s 15. k 19. l
 4. p 8. b 12. u 16. i 20. m

**** 210.**

1. odbijanie się	6. zawroty głowy	11. czkawka	16. żółtaczk
2. kolka	7. omdlenie	12. niestrawność	17. mdłości
3. zaparcie	8. zmęczenie	13. zapalenie	18. nerwoból
4. skurcz	9. gorączka	14. bezsenność	19. ropa
5. biegunka	10. zgaga	15. świąd	20. wysypka

****211.**

1. feverish	3. dizzy	5. coughing	7. rash	9. sore
2. seedy	4. swollen	6. vomit	8. queasy	10. runny

*** 212.**

1. d	6. c	11. c	16. a	21. c
2. a	7. d	12. c	17. d	22. d
3. c	8. d	13. a	18. b	23. c
4. a	9. a	14. c	19. a	24. c
5. a	10. b	15. a	20. b	25. c

213.

1. c	3. a	5. a	7. b	9. d	11. b
2. c	4. d	6. d	8. a	10. a	12. b

214.

The clinical thermometer is used FOR measuring BODY temperature. It CONSISTS OF a tube made OF glass, which CONTAINS a certain AMOUNT of mercury. When the mercury is HEATED it EXPANDS and RISES up the tube, which is graduated in degrees Fahrenheit or Centigrade DEPENDING on the country of manufacture.

*** 215.**

1. b	5. b	9. b	13. a	17. b	21. a
2. b	6. c	10. b	14. a	18. c	22. b
3. b	7. d	11. d	15. b	19. c	
4. c	8. c	12. b	16. b	20. d	

X. History

216.

- | | | | | | | | |
|------|------|------|-------|-------|-------|-------|-------|
| 1. d | 4. b | 7. a | 10. c | 13. d | 16. b | 19. d | 22. c |
| 2. b | 5. b | 8. c | 11. a | 14. a | 17. b | 20. a | 23. a |
| 3. b | 6. d | 9. d | 12. b | 15. c | 18. b | 21. a | 24. c |

* 217.

- | | | |
|-----------------------------|----------------------------|--------------------|
| 1. excavating | 6. prehistoric | 11. historic |
| 2. invention | 7. manuscripts; chronicles | 12. origin; anthem |
| 3. civilizations | 8. posterity | 13. treasures |
| 4. orb/sceptre; sceptre/orb | 9. ancestors | 14. curator |
| 5. historical (/historic) | 10. remains | |

218.

Divisions of History

The SCIENCE of dividing time into PERIODS and of giving dates to historical EVENTS is called CHRONOLOGY. History is generally divided into three periods, ANCIENT, medieval, and MODERN.

Ancient history usually begins with the story of the EGYPTIANS, Summerians, Babylonians, and Assyrians. From there it moves on to a study of the Hebrews and Phoenicians, and the Persian EMPIRE. It then shifts its EMPHASIS to the west, and deals with Greece, Carthage, and Rome. For a long time, WESTERN historians tended to NEGLECT the Far East, but historians now place INCREASING emphasis on the histories of China, JAPAN, India and other countries of the FAR EAST.

No one exactly knows where ancient HISTORY ought to end. HISTORIANS/SCHOLARS used to agree on the DATE A.D. 476, which was supposed to MARK the fall of the Roman Empire. We now know that Rome did not suddenly "fall" and that life in 477 was not much DIFFERENT from life in 475. But the end is usually given as about 400 or 500 A.D. Some historians end the MEDIEVAL period with the FALL of the Byzantine Empire in 1453. Others run the date up to 1492, so that they can start the modern ERA with the DISCOVERY of America. Since there is really no sharp DIVIDING line, many SCHOLARS/HISTORIANS prefer to begin the modern period with the ROUND number 1500.

219.

- | | | | | | | | |
|------|------|------|---------|-------|-------|-------|-------|
| 1. c | 4. b | 7. a | 10. a/c | 13. d | 16. a | 19. c | 22. b |
| 2. c | 5. d | 8. c | 11. b | 14. b | 17. c | 20. d | 23. b |
| 3. c | 6. b | 9. c | 12. c | 15. a | 18. c | 21. a | 24. b |

220.

Events of the Renaissance

- c. 1300 The Renaissance began in Italy with Giotto's PAINTINGS and WRITINGS by Petrarch and Boccaccio
- 1334—1351 The Black DEATH swept across Europe, destroying about a quarter of the POPULATION
- 1337—1453 France and England FOUGHT the Hundred Years' WAR, a series of wars broken by truces and TREATIES. It began with the English INVASION of Normandy. The English won the battles of Crecy, Poitiers, and Agincourt, but the French DEFEATED them at Orleans, and finally drove them out of France
- 1378—1417 The Great SCHISM divided the Roman Catholic Church. Two popes, one Italian and one French, claimed control of the CHURCH.
- 1429 Joan of Arc led the French to VICTORY over the English in the Battle of Orleans. Later, the English burned her at the STAKE in Rouen

- c. 1440 Johannes Gutenberg, a German printer, INVENTED movable type for PRINTING
 c. 1485 England came under the INFLUENCE of the Renaissance after the Wars of the ROSES, which ended in 1485
 1517 Martin Luther, a German MONK, began the Protestant REFORMATION in Germany when he nailed his Ninety-Five THESES to the door of All Saints' Church in Wittenberg
 1519—22 Spanish SHIPS made the first VOYAGE around the world. Ferdinand Magellan, the Portuguese navigator and EXPLORER, commanded the voyage

221.

- | | | | | | |
|------|------|------|------|-------|-------|
| 1. d | 3. d | 5. b | 7. a | 9. c | 11. c |
| 2. c | 4. a | 6. a | 8. d | 10. a | 12. a |

* 222.

Royal Family: consort, king, prince, princess, queen

Royal Household: herald, jester, minstrel, lady-in-waiting, page

Peerage: baron, duke, earl, marquis

Knight (equipment): armour, gauntlet, lance, shield, sword

Castle: banqueting-hall, battlement, bedchamber, courtyard, drawbridge, dungeon, fortress, moat, tower, turret

223.

- | | | | | |
|------------|--------------|------------|-----------|-----------|
| 1 — armour | 2 — gauntlet | 3 — shield | 4 — sword | 5 — lance |
|------------|--------------|------------|-----------|-----------|

* 224.

- | | | | | | |
|------|------|------|------|-------|-------|
| 1. c | 3. d | 5. d | 7. c | 9. b | 11. d |
| 2. c | 4. b | 6. a | 8. d | 10. b | 12. d |

XI. Houses and Homes

225.

- | | | |
|-------------------------|----------------|---------------------|
| 1 — semi-detached house | 6 — mansion | 10 — terraced house |
| 2 — block of flats | 7 — lighthouse | 11 — palace |
| 3 — bungalow | 8 — houseboat | 12 — caravan |
| 4 — detached house | 9 — tent | 13 — windmill |
| 5 — cottage | | 14 — castle |

226.

- | | | | | |
|------|------|------|------|-------|
| 1. b | 3. a | 5. c | 7. c | 9. b |
| 2. d | 4. b | 6. c | 8. c | 10. a |

227.

- | | |
|---|--|
| 1. soldiers | 7. rich people in the country |
| 2. people on holidays; rich people; businessmen | 8. working-class people in an old district of town |
| 3. poor people | 9. homeless people on the edge of a big city |
| 4. Eskimos | 10. people on camping holidays |
| 5. people on a journey | 11. Red Indians |
| 6. students; people too poor to buy a flat of their own | |

228.

- | | | |
|----------------|-------------------|-------------|
| 1. castle | 5. cottage | 9. detached |
| 2. skyscrapers | 6. pigsty | 10. shed |
| 3. hostel | 7. prison | |
| 4. bungalow | 8. block of flats | |

229.

- | | |
|-------------|---------------|
| 1. unique | 4. suburbs |
| 2. designed | 5. move |
| 3. pavement | 6. surrounded |

230.

Kinds of Housing

About two-thirds of FAMILIES in the United States live in single-family HOMES. About a QUARTER of the families live in BUILDINGS that have two to four APARTMENTS, or in STORES or other commercial buildings that include apartments.

LARGE cities have more apartment housing than small COMMUNITIES because LAND is scarce and EXPENSIVE. Small towns and SUBURBAN areas, where land is LESS expensive than in city centres, have mostly SINGLE-FAMILY homes.

Philadelphia and other CITIES have many ROW houses. These are usually single-family houses, one or two FLOORS high, standing WALL to wall. A DUPLEX is a building with two apartments, either SIDE by side with a SINGLE wall BETWEEN them, or one ABOVE the other.

231.

- | | | |
|----------------|---------------------|----------------------|
| 1. tent | 4. monastery | 7. (log-)cabin |
| 2. guest house | 5. convent; nunnery | 8. old people's home |
| 3. palace | 6. ranch-house | 9. chalet |

232.

- | | | | | |
|------|------|------|------|-------|
| 1. d | 3. a | 5. c | 7. d | 9. d |
| 2. d | 4. a | 6. a | 8. b | 10. b |

233.

- | | | | |
|------|------|------|-------|
| 1. e | 4. g | 7. i | 10. c |
| 2. f | 5. a | 8. j | 11. h |
| 3. b | 6. d | 9. k | |

234.

- | | | | | |
|------|------|------|------|-------|
| 1. b | 3. c | 5. d | 7. a | 9. c |
| 2. a | 4. c | 6. d | 8. d | 10. a |

* 235.

Buying a House

When a BUYER/PURCHASER has chosen the house he wants, he has a LAWYER draw up a contract. This DOCUMENT states the LEGAL definition of the PROPERTY, gives the purchase PRICE, and demands PROOF OF OWNERSHIP from the present owner.

It also includes other important INFORMATION, such as the FIXTURES that are to remain in the house and the TIME when the PURCHASER/BUYER will take POSSESSION.

The buyer pays a DEPOSIT when he SIGNS the CONTRACT.

The deposit binds the SELLER to the TERMS of the contract.

* 236.

- | | | | | |
|------|------|------|------|-------|
| 1. b | 3. d | 5. c | 7. a | 9. a |
| 2. d | 4. a | 6. a | 8. d | 10. c |

** 237.

Modern detached house in immaculate condition. Freehold. 3 garages, 5 bedrooms, 3 reception rooms, 2 fully tiled bathrooms plus separate water closets; large fitted kitchen, 18 × 9 feet with a double sink; luxurious lounge. Gas central heating and centrally heated water; double glazed windows. Curtains and fitted carpets included. Landscaped garden, swimming pool. Few minutes from the train station, bus, amenities, seafront, \$ 150.000 or nearest offer.

238.

- | | | | | | |
|------|------|------|------|-------|-------|
| 1. b | 3. b | 5. b | 7. c | 9. d | 11. b |
| 2. b | 4. b | 6. d | 8. b | 10. c | |

239.

- | | | | | |
|------|------|-------|-------|-------|
| 1. b | 5. d | 9. d | 13. b | 17. d |
| 2. d | 6. b | 10. c | 14. b | 18. a |
| 3. b | 7. c | 11. d | 15. d | 19. d |
| 4. c | 8. b | 12. c | 16. d | 20. a |

** 240.

A luxurious self-contained single furnished flat with a garden. One room, kitchen and bathroom. Central heating. Carpets, colour television set, telephone, fridge, cooker, hot and cold water. Rent \$ 180 per month. References required. Available from middle of April. Telephone: 01-678-1234 in the evenings after 7 o'clock.

241.

- | | | | | |
|------|------|------|------|-------|
| 1. d | 3. b | 5. b | 7. d | 9. d |
| 2. b | 4. d | 6. a | 8. c | 10. c |

* 242.

- | | | | | |
|------|------|------|------|------|
| 1. d | 2. a | 3. d | 4. d | 5. c |
|------|------|------|------|------|

243.

1. immediately below the roof of a house; a room that may be lived in
2. below the ground floor, wholly or partly underground; may be lived in or be part of a shop
3. below the ground floor, wholly or partly underground; unlike a basement used for storing goods (wine, coal etc.)
4. usually attached to the kitchen; a storeroom for food
5. in or next to the bathroom; water closet
6. at the top of the building, under the roof; unlike an attic used for storage
7. on the main floor of the house; used for entertaining guests, watching TV, but not usually for eating
8. probably on the main living floor; used for reading, studying

* 244.

- | | | | | |
|------|------|------|-------|-------|
| 1. c | 4. m | 7. h | 10. f | 13. o |
| 2. k | 5. e | 8. j | 11. i | 14. g |
| 3. l | 6. a | 9. b | 12. n | 15. d |

*** 245.**

- | | | | |
|------------|-------------|--------------------|---------------|
| 1 — attic | 3 — porch | 5 — French windows | 7 — guttering |
| 2 — alcove | 4 — chimney | 6 — cellar | 8 — skylight |

246.

- | | | | | |
|------|------|-------|-------|-------|
| 1. c | 5. a | 9. c | 13. a | 17. c |
| 2. a | 6. c | 10. d | 14. a | 18. b |
| 3. c | 7. c | 11. b | 15. b | 19. a |
| 4. a | 8. d | 12. b | 16. d | 20. a |

247.

- | | | | |
|--------------------|-------------------|---------------|------------------|
| 1. a studio | 4. a greenhouse | 7. a darkroom | 10. a mess |
| 2. a mortuary | 5. a study | 8. a cockpit | 11. a canteen |
| 3. a changing room | 6. a waiting room | 9. a cell | 12. a staff-room |

*** 248.**

- | | | | | |
|------|------|------|------|-------|
| 1. a | 3. c | 5. c | 7. a | 9. c |
| 2. c | 4. d | 6. a | 8. c | 10. d |

249.

- | | | |
|-------------------|-------------|-------------------|
| 1. rent | 6. deeds | 11. mess |
| 2. hall | 7. breathe | 12. mortgage |
| 3. entrance; back | 8. unlocked | 13. separate |
| 4. decorated | 9. bath | 14. lounge |
| 5. bedroom | 10. knock | 15. advertisement |

250.

- | | | | | |
|------|------|------|-------|-------|
| 1. b | 4. c | 7. b | 10. b | 13. d |
| 2. a | 5. a | 8. c | 11. d | |
| 3. b | 6. d | 9. c | 12. c | |

251.

- | | |
|-------------|-----------|
| 1. darkness | 4. rent |
| 2. length | 5. suburb |
| 3. unload | |

*** 252.**

- | | | | | |
|------|------|------|------|-------|
| 1. d | 3. d | 5. d | 7. c | 9. a |
| 2. d | 4. d | 6. b | 8. d | 10. a |

253.

- | | | | | | |
|------|------|------|-------|-------|-------|
| 1. a | 4. c | 7. d | 10. d | 13. d | 16. d |
| 2. c | 5. d | 8. a | 11. b | 14. d | 17. d |
| 3. d | 6. d | 9. d | 12. b | 15. b | 18. a |

254.

- | | | |
|--------------|---------------|------------------|
| 1 — radiator | 4 — armchair | 7 — lampshade |
| 2 — curtains | 5 — settee | 8 — coffee table |
| 3 — carpet | 6 — fireplace | 9 — clock |

255.

- | | | | | | |
|------|------|------|------|-------|-------|
| 1. d | 3. d | 5. d | 7. a | 9. c | 11. c |
| 2. c | 4. a | 6. b | 8. b | 10. b | 12. d |

*** 256.**

- | | | | | | |
|------|------|------|------|-------|-------|
| 1. a | 3. c | 5. d | 7. b | 9. b | 11. a |
| 2. b | 4. d | 6. c | 8. b | 10. c | 12. b |

257.

- | | |
|------------------|----------------------|
| 5 — wardrobe | 7 — bedside-table |
| 10 — pillow | 4 — dressing-table |
| 11 — pillow-case | 6 — stool |
| 9 — sheet | 3 — mirror |
| 12 — bedspread | 2 — chest-of-drawers |
| 8 — mattress | 1 — rug |

258.

1. A bureau: writing paper, documents
2. A chest of drawers: easily folded clothes such as underwear, socks, stocking
3. A linen chest: bedding, sheets, pillow cases
4. A safe: items of value, such as money, jewels, important documents
5. A sideboard: plates, glasses, etc.
6. A wardrobe: suits, dresses, etc.

259.

- | | | |
|----------------------|----------------|-----------------|
| 1 — bath | 5 — lavatory | 2 — tap |
| 13 — bathmat | 10 — nailbrush | 6 — toilet-roll |
| 7 — bathroom cabinet | 4 — plug-hole | 9 — tooth-mug |
| 12 — bathroom scales | 3 — shower | 11 — towel rail |
| 15 — laundry basket | 14 — sponge | 8 — wash-basin |

260.

- | FURNITURE | HOUSEHOLD APPLIANCES | SOFT FURNISHINGS |
|-------------|----------------------|------------------|
| beds | cooker | bedding |
| bookshelves | dishwasher | carpets |
| chairs | freezer | curtains |
| sideboard | refrigerator | cushions |
| tables | telephone | rugs |
| wardrobes | television | tablecloths |
| | vacuum cleaner | |

*** 261.**

- | | | | | | |
|------|------|------|------|-------|-------|
| 1. c | 3. b | 5. c | 7. c | 9. d | 11. b |
| 2. d | 4. b | 6. b | 8. d | 10. b | 12. b |

262.

- | | | |
|--------------------|-------------------|-------------------|
| 1. wardrobe | 6. artificial | 11. radiator |
| 2. plates; candles | 7. aerial | 12. revolving |
| 3. fireplace | 8. length | 13. accommodation |
| 4. homely/heated | 9. enough, settee | 14. cupboards |
| 5. armchair; pipe | 10. drawers | 15. hinges |

263.

- | | | | | |
|------|------|------|-------|-------|
| 1. b | 4. d | 7. c | 10. d | 13. b |
| 2. a | 5. b | 8. d | 11. c | 14. b |
| 3. c | 6. d | 9. c | 12. c | 15. c |

* 264.

- | | | | | | | | | | |
|------|------|------|------|-------|-------|-------|-------|-------|-------|
| 1. c | 3. b | 5. c | 7. d | 9. d | 11. d | 13. a | 15. a | 17. a | 19. b |
| 2. c | 4. d | 6. a | 8. d | 10. d | 12. d | 14. d | 16. b | 18. a | 20. a |

265.

- | | |
|-----------------|----------------|
| 11 — thread | 7 — screw |
| 2 — chain | 4 — nut |
| 10 — string | 6 — safety pin |
| 8 — rope | 5 — pin |
| 9 — rubber band | 1 — bolt |
| 3 — nail | |

266.

- | | | | | | |
|----|---|---|---|---|---|
| 1 | S | C | R | E | W |
| 2 | R | O | P | E | |
| 3 | P | I | N | | |
| 4 | | N | A | I | L |
| 5 | T | H | R | E | A |
| 6 | | C | H | A | I |
| 7 | N | U | T | | |
| 8 | B | O | L | T | |
| 9 | D | R | A | W | I |
| 10 | | S | T | R | I |

267.

- | | | | |
|------------|------------------|--------------|-------------|
| 9 — axe | 1 — chisel | 12 — drill | 7 — file |
| 4 — hammer | 10 — screwdriver | 8 — penknife | 11 — plane |
| 2 — pliers | 6 — saw | 5 — scissors | 3 — spanner |

268.

- | | | | | |
|-------------|-----------|----------------|-----------|---------------|
| 1. axe | 3. hammer | 5. screwdriver | 7. saw | 9. pickaxe |
| 2. scissors | 4. jack | 6. spanner | 8. pliers | 10. corkscrew |

269.

- | | | | | |
|------|------|------|------|-------|
| 1. a | 3. d | 5. a | 7. c | 9. c |
| 2. b | 4. d | 6. d | 8. d | 10. b |

270.

- | | | | | |
|------|------|-------|-------|-------|
| 1. d | 5. a | 9. c | 13. d | 17. d |
| 2. a | 6. b | 10. a | 14. c | 18. d |
| 3. a | 7. d | 11. b | 15. d | 19. d |
| 4. c | 8. d | 12. d | 16. b | 20. c |

* 271.

- | | | | | |
|------|------|------|------|-------|
| 1. a | 3. c | 5. b | 7. d | 9. c |
| 2. b | 4. d | 6. b | 8. c | 10. a |

* 272.

- | | | | | |
|------|------|------|-------|-------|
| 1. b | 4. b | 7. a | 10. d | 13. c |
| 2. d | 5. c | 8. c | 11. c | 14. c |
| 3. a | 6. d | 9. c | 12. b | 15. b |

* 273.

- | | | | | |
|------|------|------|-------|-------|
| 1. c | 4. a | 7. c | 10. c | 13. c |
| 2. a | 5. a | 8. c | 11. b | 14. a |
| 3. d | 6. c | 9. b | 12. c | |

274.

- | | | | | |
|------|------|------|------|-------|
| 1. d | 3. c | 5. c | 7. d | 9. b |
| 2. a | 4. d | 6. c | 8. c | 10. d |

275.

- | | | | | |
|----------|-------------|------------|----------------|-----------|
| 1. major | 3. isolated | 5. map | 7. country | 9. soil |
| 2. rural | 4. bank | 6. suburbs | 8. countryside | 10. piece |

* 276.

- | | | | | | |
|------|------|------|------|------|------|
| 1. d | 2. a | 3. d | 4. b | 5. c | 6. b |
|------|------|------|------|------|------|

* 277.

- | | | | | |
|------|------|------|------|-------|
| 1. d | 3. b | 5. b | 7. a | 9. b |
| 2. c | 4. d | 6. c | 8. d | 10. c |

278.

1										
2										
3										
4										
5										
6										

H O M E
 C O U N T R Y
 S U R R O U N D I N G S
 S C E N E R Y
 N A T U R E
 C O U N T R Y S I D E

XII. Money and Banking

279.

- | | | | | |
|------|-------|-------|-------|-------|
| 1. d | 6. a | 11. c | 16. d | 21. d |
| 2. a | 7. d | 12. b | 17. a | 22. c |
| 3. d | 8. a | 13. b | 18. d | 23. a |
| 4. a | 9. a | 14. a | 19. a | 24. b |
| 5. c | 10. a | 15. c | 20. a | |

**** 280.**

- | | | | | |
|-----------|------------|-------------|---------------|------------|
| 1. salary | 4. cash | 7. duty | 10. a fee | 13. a fine |
| 2. a loan | 5. a wage | 8. a bill | 11. a grant | 14. taxes |
| 3. a debt | 6. alimony | 9. interest | 12. a pension | 15. a fare |

281.**Money**

Money is what people use to BUY things. People spend money on GOODS and services. Many people save part of their money by DEPOSITING it in a bank. People EARN money by performing services. They also earn money from INVESTMENTS, including government bonds, and from SAVINGS ACCOUNTS.

MONEY can be anything that people agree to accept in exchange for the things they SELL or the work they do. Ancient peoples used such varied things as BEADS/SHELLS, SHELLS/BEADS, and cattle as money. Today, most nations use metal coins and PAPER BILLS. Different countries' COINS and bills look different and have different names.

A person can CHANGE his money for the money of any country according to the EXCHANGE RATE. Usually, such rates are set by the central BANKS of a country. The VALUE of a country's CURRENCY may change, depending on the economic and political conditions in that country.

**** 282.**

- | | | | | |
|------|------|------|-------|-------|
| 1. e | 4. l | 7. h | 10. d | 13. c |
| 2. f | 5. i | 8. j | 11. a | |
| 3. m | 6. b | 9. g | 12. k | |

*** 283.**

- | | | | | |
|------|-------|-------|-------|-------|
| 1. c | 6. d | 11. d | 16. d | 21. d |
| 2. d | 7. a | 12. c | 17. d | 22. b |
| 3. d | 8. b | 13. d | 18. d | 23. a |
| 4. d | 9. d | 14. a | 19. c | 24. c |
| 5. a | 10. c | 15. b | 20. c | 25. d |

284.

- | | | |
|----------------------|-----------------------|----------------------|
| 1. fares | 5. investment | 9. saving; financial |
| 2. duty | 6. standard; per cent | 10. equal |
| 3. pension; interest | 7. mortgage | 11. cheque; credit |
| 4. well; salary | 8. obligation | 12. notes; wallet |

285.

- | | | | | | |
|------|------|-------|-------|-------|-------|
| 1. b | 5. c | 9. c | 13. d | 17. a | 21. b |
| 2. c | 6. c | 10. d | 14. d | 18. d | 22. d |
| 3. d | 7. a | 11. d | 15. a | 19. c | 23. c |
| 4. b | 8. c | 12. a | 16. b | 20. a | 24. a |

286.**Banks**

People SAVE money in banks for future use. A man may be PAID each week for his work. He probably will not want to SPEND all his pay the day he receives it. It may be risky for him to carry all his unspent money in his POCKET, or to HIDE it at home. So he may decide to put some of his money in a bank for SAFEKEEPING. The money he puts in the bank is called a DEPOSIT. This money is CREDITED, or added, to his ACCOUNT. An account is a RECORD of the money a depositor has in

the bank. When the depositor wants to WITHDRAW, or take out, part of his deposit, the BANK must be ready to pay him.

Banks use the money of DEPOSITORS for loans to those who need FUNDS. The bank that makes the loan is called a lender, or CREDITOR. The bank charges the borrower, or DEBTOR, interest for the use of the LOAN. Charging INTEREST for the use of money is the chief source of BANK INCOME.

* 287.

1. c 2. c 3. a 4. c 5. b 6. a

XII. Plants

** 288.

Kinds of Plants

SCIENTISTS know that there are more than 335,000 different SPECIES of plants. Actually, if we travelled all over the WORLD we could see more different kinds of plants than these, but some of these are merely VARIETIES, much as dogs are merely different BREEDS of one basic kind of animal.

The simplest plants found in the PLANT KINGDOM are one-called BACTERIA and algae, and FUNGI that are like the moulds often seen growing on bread and CHEESE.

The next group of relatively simple PLANTS includes the mosses and lichens that are found in FORESTS, on bare ROCKS, on rooftops, and elsewhere. Some of these plants have STEMS and leaves, but no roots. After that, the next group includes ferns and bracken. Finally, there is the group of SEED-BEARING plants. Such plants include our common GRASSES and vegetables, and most trees, SHRUBS, and flowers.

289.

- | | | | | |
|------|------|-------|-------|-------|
| 1. a | 5. c | 9. a | 13. c | 17. a |
| 2. d | 6. c | 10. d | 14. d | 18. b |
| 3. c | 7. d | 11. b | 15. d | 19. c |
| 4. a | 8. d | 12. c | 16. a | 20. c |

290.

The Appearance of Plants

Plants can be almost any colour IMAGINABLE. They may be ENORMOUS or so small that you cannot see them with the NAKED eye. A giant SEAWEED is just as much a plant as a PINE tree, YEAST plant, or a bacterium which is too SMALL to see.

Some plants flourish in HOT climates, while others live equally successfully on SNOW and ice. Some carry out their life processes in total DARKNESS, while others are at their best in BRIGHT sunlight.

A whole SCIENCE known as ecology has grown up to help us understand the relationship between the ENVIRONMENT and living things there. AGRICULTURE, forestry, and HORTICULTURE are the sciences of learning how to make living things do what we want them to do in a given place.

** 291.

- | | | |
|------------|--------------|-------------------|
| 1. jesion | 6. jodla | 11. dąb |
| 2. osika | 7. leszczyna | 12. sosna |
| 3. brzoza | 8. modrzew | 13. topola |
| 4. kasztan | 9. lipa | 14. orzech włoski |
| 5. wiąz | 10. klon | 15. wierzba |

**** 292.**

Deciduous trees are: ash, aspen, birch, chestnut, elm, hazel, larch, linden, maple, oak, poplar,
walnut, willow

Coniferous trees are: fir, larch, pine

Evergreens are: fir and pine

*** 293.**

Stems

Stems are parts of plants that may be organs of food STORAGE or of REPRODUCTION. They may be useful in moving LIQUIDS from one part of the plant to another, or they may merely hold certain parts high in the AIR. The TISSUE of stems may be SOFT and weak or hard and woody. The different groups of WOODY PLANTS are vines, trees, and shrubs.

Vines are rarely ERECT. They CLIMB, wind or SPREAD over some support. Trees have a single trunk, with a BRANCHING HEAD and are, when mature, normally over three metres TALL. SHRUBS, on the other hand, do not have a TRUNK. They usually branch close to the GROUND and are not very tall.

**** 294.**

1. j	3. i	5. h	7. a	9. l	11. f
2. k	4. c	6. d	8. g	10. b	12. e

*** 295.**

1. d	3. b	5. c	7. b	9. d	11. c
2. b	4. c	6. d	8. d	10. c	12. a

**** 296.**

Herbs

Herb is a low-growing plant that has a FLESHY or juicy stem when it is young. The word 'herb' comes from Latin word 'herba', meaning 'grass' or BLADES. Some herbs are used in cooking. Although they have little food VALUE, they make food tasty and full of FLAVOUR. Other herbs give SCENT to perfumes. Others still are used for MEDICINES.

Herbs are frequently CLASSIFIED, as annuals, BIENNIALS, and perennials. An annual goes through its LIFE-CYCLE from seed to SEED in a year. A biennial requires two SEASONS to complete the cycle. A PERENNIAL may live many seasons; producing seeds YEAR after year once the plant had become MATURE.

*** 297.**

1. d	3. c	5. c	7. b	9. a
2. d	4. b	6. c	8. b	10. b

XIV. Post Office and Telephones

298.

1. c	5. c	9. b	13. a	17. d
2. a	6. c	10. c	14. a	18. a
3. b	7. b	11. a	15. b	19. c
4. b	8. c	12. c	16. a	20. b

299.

1		P	O	S	T	A	G	E			
2		O	R	D	I	N	A	R	Y		
3		S	T	A	M	P					
4	P	O	S	T	C	A	R	D			
5		M	A	I	L						
6		P	I	L	L	A	R	-	B	O	X
7		P	O	S	T	M	A	N			
8		R	E	G	I	S	T	E	R	E	D
9	A	D	D	R	E	S	S	E	E		
10	D	E	L	I	V	E	R				
11		P	R	I	N	T	E	D			
12		C	O	D	E						
13	P	A	R	C	E	L					

300.

Making a Telephone-call

When you make a telephone-call you **LIFT** the receiver. Then you **DIAL** the number. If you don't know the **NUMBER** you can look it up in the **TELEPHONE DIRECTORY**. If you can't find it there you can call **DIRECTORY ENQUIRIES**.

Making a call to a place far away is called a **LONG-DISTANCE** call. For most countries in Europe you can phone **DIRECT**; first dial the **INTERNATIONAL CODE-NUMBER**.

If you don't have enough money you can ask for a **PERSON-TO-PERSON** call and have the **CHARGES REVERSED**. This means that the **RECEIVER** of the call has to pay for it.

When there is a difficulty with the **CONNECTION** the **OPERATOR** may tell you to hold the line. If the person we want to call is already speaking to someone, the number is **ENGAGED**.

When you call a friend and somebody else answers the phone, you can leave a **MESSAGE**, or, it may mean that you have dialled a **WRONG NUMBER**.

301.

- | | | | | | |
|------|------|-------|-------|-------|-------|
| 1. b | 5. c | 9. c | 13. a | 17. b | 21. c |
| 2. d | 6. a | 10. c | 14. c | 18. c | 22. b |
| 3. a | 7. b | 11. a | 15. b | 19. a | 23. b |
| 4. c | 8. b | 12. b | 16. b | 20. a | 24. b |

302.

Telephone Etiquette

1. Know the right number before making a **CALL**. When in doubt consult a **DIRECTORY**, your personal number list, or the information **OPERATOR**.
2. Allow time to **ANSWER**. Give the person you are calling enough time to **REACH** his telephone. A little patience may **SAVE** you a second call.
3. Speak distinctly and in a normal **TONE** of voice. Your lips should be about an inch away from the **MOUTHPIECE**.
4. Answer promptly. Try to answer your telephone on the first **RING**. Otherwise the **CALLER** may hang up and you might miss an important message.
5. **IDENTIFY** yourself when you answer the **TELEPHONE**. Do not merely say "Hello." Give your name, your telephone **NUMBER**, or the name of your firm.
6. Take messages for people who are not there. Write down the name and telephone number of the person calling. Place the **MESSAGE** where it can be seen.
7. **HANG UP** gently. Slamming the **RECEIVER** down is discourteous. Be sure the receiver is always **REPLACED** properly. Otherwise no calls can **COME THROUGH** to you.

XV. Religion

303.

- | | | |
|-----------------|-------------|------------|
| 1 — aisle | 6 — chalice | 4 — pew |
| 5 — altar | 3 — font | 2 — pulpit |
| 7 — candlestick | | |

304.

- | | | |
|--|---------------------------|-----------------|
| 1. diocese | 5. worship | 10. paradise |
| 2. parish | 6. service; mass | 11. gospels |
| 3. heaven; saints/angels;
angels/saints | 7. prayers; sermon | 12. sins |
| 4. cardinals | 8. congregation; blessing | 13. Devil; hell |
| | 9. Creation | 14. convert |

* 305.

Christianity

Jesus Christ founded the Christian RELIGION. He began His teaching in Palestine, instructing and PREACHING to people about the Kingdom of HEAVEN. He travelled around the country with a group of FOLLOWERS called disciples. He chose 12 disciples called APOSTLES, to preach His doctrine. Like the Old Testament PROPHETS, Jesus insisted upon justice toward men and HUMILITY toward God. He also preached mercy and the BROTHERHOOD of men, and told of the love of GOD for all CREATURES.

The Jewish religious LEADERS of Jesus' time did not approve of His claim that he was the Messiah, or the promised DELIVERER of the Jews. They considered this action to be BLASPHEMY. The Roman authorities feared that He meant to lead an UPRISING against Roman rule in Palestine. As a result, He was tried, CONDEMNED to death, and CRUCIFIED.

After the death of Jesus, His DISCIPLES scattered in fear. However, they soon reassembled. One after another of them, beginning on the first EASTER morning, reported that they had met Jesus alive. This rising from the DEAD is called the Resurrection, and forms one of the basic DOCTRINES of the Christian faith. According to CHRISTIAN teaching, Jesus remained on earth for 40 days after His RESURRECTION, and then ASCENDED into Heaven.

** 306.

- | | | | | |
|---------|---------|---------|----------|----------|
| 1. a; h | 4. a | 7. b | 10. h; i | 13. e |
| 2. a; h | 5. a; h | 8. f; g | 11. d | 14. c |
| 3. c | 6. g | 9. d | 12. h | 15. a; h |

* 307.

The Clergymen of the Church of England

Here are Church of England, or ANGLICAN Church, CLERGYMEN arranged in order of importance: an archbishop, a BISHOP, a vicar, a curate. A VICAR is sometimes called a rector, and his house a vicarage, or a RECTORY. A dean is the clergyman in charge of a CATHEDRAL. A churchwarden is a LAYMAN (not a clergyman) who shares responsibility for church business matters. The organist plays the organ and the CHOIRMASTER trains the church choir.

** 308.

- | | |
|--------------------------------|----------------------|
| 1. Christianity; reincarnation | 4. Hinduism; church |
| 2. Islam; curate | 5. Buddhism; baptism |
| 3. Judaism; saints | |

309.

1. d 4. b 7. d 10. b 13. a
2. a 5. b 8. a 11. a 14. b
3. c 6. c 9. d 12. c 15. c

** 310.

temptation — sin sorrow for sin — determination to atone — confession — penance —
absolution — Holy Communion

* 311.

1. c 3. d 5. d 7. d 9. c
2. d 4. c 6. c 8. d 10. c

XVI. Sea Travel

312.

	river	canal	lake	sea	ocean	harbour	underwater
a barge	+	+					
a cargo boat				+			
a ferry	+		+	+			
a liner				+	+		
a rowing boat	+		+				
a submarine							+
an oil tanker				+			
a yacht			+	+		+	

313.

1. c 4. a 7. a 10. a 13. c
2. d 5. d 8. c 11. b
3. c 6. d 9. c 12. c

314.

The listed ships and boats are usually used for:

1. carrying cargo
2. carrying cargo
3. carrying passengers and cargo from one side of a lake /river/ short sea crossing to the other
4. carrying passengers
5. may be used for pleasure
6. a warship
7. carrying petrol or crude oil
8. a pleasure boat used for sailing

**** 315.**

	funnels	guns	masts	oars	passengers
a barge					
a cargo boat	+		+		
a ferry boat	(+)				+
a liner	+		+	+	+
a rowing boat					+
a submarine		+			
an oil tanker	+		+		
a yacht			+		+

316.

1. a 3. c 5. b 7. c 9. b 11. a
2. b 4. a 6. b 8. c 10. b 12. c

**** 317.**

- 1 — bow 3 — anchor 5 — stern 7 — rudder
2 — funnel 4 — mast 6 — propeller

*** 318.**

1. a 4. a 7. b 10. c 13. b 16. d 19. d 22. b 25. c
2. b 5. d 8. a 11. d 14. a 17. b 20. d 23. c
3. d 6. a 9. c 12. b 15. a 18. c 21. b 24. a

319.

1. Kinds of ships: freighters, liner, warships
2. Parts of a ship: bow, cabins, galley, gang-way, hold, rudder, stern
3. Things found on a ship: bunks, compass, deck-chairs, life-jacket, rope
4. People found on a ship: captain, crew, mate, navigator, scamen, stewards

*** 320.**

Ships and Sea Travel

When a ship goes out to sea it leaves the **HARBOUR**, or port. The speed of a ship is measured in **KNOTS**. The foremost part of the ship is the **BOW**. The name of the ship is often painted on the back. This part of a ship is called the **STERN**. A **RUDDER** is used to steer the ship. The goods are stored in the **HOLD**.

The man in command on board is the **CAPTAIN**. The first **MATE** is responsible for navigation. To **NAVIGATE** a ship the sailors need maps, a **COMPASS** and other instruments. Sea-maps are called **CHARTS**. A **NAVIGATOR** knows where they are at sea by finding the longitude and **LATITUDE**.

All the people who work on board are **SEAMEN**. Together they are called the **CREW** of the ship. The crew sleep in **BUNKS**, or berths.

A holiday-trip by ship is a **CRUISE**. When passengers go on to a ship we say that they **EMBARK**, or board the ship. When you want to leave or **BOARD** the ship you have to use the gang-plank, or **GANG-WAY**.

Holidaymakers on board can sit in **DECK-CHAIRS**. They sleep in **CABINS**. Passengers are served food by the **STEWARDS**. The food is prepared in the **GALLEY**.

Sometimes the **VOYAGE** can be dangerous, especially when the coast consists of steep rocks called **CLIFFS**. Along the more dangerous parts of the **COAST** there are usually **LIGHTHOUSES** used for warning ships at sea.

If a ship runs into rocks it becomes a **WRECK**. If your ship is wrecked you have to jump **OVERBOARD**. Then you should wear a **LIFE-JACKET**.

When it's STORMY weather the surface of the water begins to move. These movements of the water are called WAVES. When the waves are very high many people suffer from SEASICKNESS.

Ships are LOADED and repaired in DOCKS. They are loaded and unloaded by CRANES. Ships which carry cargoes are called FREIGHTERS and those which are used for war purposes are WARSHIPS. A ship which is part of a commercial FLEET is called a LINER. A general term for ships and boats is VESSELS. After a ship has sailed into the harbour it is MOORED. This is mostly done with a ROPE or cable.

XVII. Shopping

321.

- | | | | | | |
|------|------|------|------|-------|-------|
| 1. c | 3. b | 5. d | 7. b | 9. b | 11. d |
| 2. d | 4. d | 6. d | 8. c | 10. b | |

322.

Department Store

A department store is a STORE which sells many DIFFERENT kinds of goods, each in a separate DEPARTMENT. Modern department stores serve the NEEDS of entire FAMILIES. People enjoy SHOPPING in such stores because they can make all their PURCHASES under one ROOF.

The TYPICAL department store OCCUPIES one large building, with separate departments LOCATED on a number of FLOORS. A number provide special SERVICES, such as a TRAVEL AGENCY or OPTICIAN'S.

Department stores EMPLOY hundreds of people for different JOBS. Employess buy, PRICE, and sell the GOODS/MERCHANDISE. The SALES PROMOTION manager and his STAFF promote the sale of MERCHANDISE/GOODS through ADVERTISING and other techniques. The comptroller heads the SECTION that keeps RECORDS and manages the store's FINANCIAL affairs. The PERSONNEL staff hire employees and HANDLES other employment problems.

* 323.

- | | | | | | |
|------|------|------|------|------|------|
| 1. c | 2. c | 3. d | 4. d | 5. b | 6. b |
|------|------|------|------|------|------|

324.

- | | | | | | |
|------|------|------|------|-------|-------|
| 1. c | 3. i | 5. h | 7. k | 9. f | 11. c |
| 2. g | 4. a | 6. l | 8. j | 10. d | 12. b |

325.

- | | | | |
|------------------|-----------------|-----------------|-----------------|
| a) greengrocer's | c) pct shop | i) stationer's | l) grocer's |
| b) chemist's | f) ironmonger's | j) florist's | m) antique shop |
| c) baker's | g) butcher's | k) fishmonger's | n) off-licence |
| d) tobacconist's | h) newsagent's | | |

326.

- | | | | | | |
|------|------|------|------|------|------|
| 1. d | 2. b | 3. c | 4. b | 5. a | 6. d |
|------|------|------|------|------|------|

* 327.

- | | |
|---|--|
| 1. BAKER'S: buns, cakes, fruit pies, rolls | 6. GROCER'S: biscuits, flour |
| 2. BUTCHER'S: chops, lamb, mince, sausages | 7. IRONMONGER'S: bolts, buckets, pliers, rakes |
| 3. GREENGROCER'S: grapes, leeks, lettuces, peaches | 8. MUSIC SHOP: cassettes, organs, records, violins |
| 4. CHEMIST'S: medicines, shampoo, soaps, vitamins | 9. SPORTS SHOP: balls, bats, rackets, shorts |
| 5. ELECTRICAL SHOP: batteries, light bulbs, hairdryers, plugs | 10. SHOE SHOP: boots, slippers, sandals, shoes |

328.

Advertising

Advertising is a form of SELLING. Advertising SEEKS to make people AWARE of things they need and to make them want these THINGS. It tells what PRODUCTS or services are on the MARKET, and how they can be OBTAINED.

It ANNOUNCES/DESCRIBES new products, and DESCRIBES/ANNOUNCES new uses and IMPROVED features of FAMILIAR ones.

Advertising SUGGESTS that we might enjoy more nourishing FOODS, more attractive CLOTHES, and more COMFORTABLE homes. In doing all these things, ADVERTISING helps us to improve our way of LIVING. It also shapes our TASTES, habits and CUSTOMS.

Advertising MESSAGES are carried to large AUDIENCES by newspapers. MAGAZINES, television, RADIO, and other means of MASS COMMUNICATION.

329.

- | | | | |
|------|------|------|-------|
| 1. a | 4. d | 7. c | 10. a |
| 2. b | 5. c | 8. c | 11. d |
| 3. d | 6. b | 9. a | 12. d |

330.

- | | | | | |
|------|------|------|-------|-------|
| 1. d | 4. a | 7. a | 10. a | 13. a |
| 2. a | 5. c | 8. d | 11. d | 14. d |
| 3. d | 6. a | 9. b | 12. c | 15. d |

* 331.

- | | | | |
|------|------|------|-------|
| 1. b | 4. c | 7. c | 10. c |
| 2. d | 5. b | 8. c | 11. d |
| 3. b | 6. a | 9. b | 12. d |

* 332.

- | | | |
|---------------------|--------------------|------------------------|
| 1. cash | 6. try | 11. looking |
| 2. brand | 7. deal; reduce | 12. discount |
| 3. fishmonger's | 8. contain | 13. customers; counter |
| 4. check-out; queue | 9. chemist's | 14. carry; deliver |
| 5. examined | 10. notice; closed | 15. department stores |

* 333.

- | | | | |
|------|------|------|-------|
| 1. d | 4. d | 7. d | 10. a |
| 2. d | 5. b | 8. a | 11. b |
| 3. d | 6. b | 9. b | 12. b |

334.

- | | | | | |
|------|------|-------|-------|-------|
| 1. d | 5. b | 9. b | 13. b | 17. b |
| 2. a | 6. c | 10. a | 14. d | 18. a |
| 3. c | 7. a | 11. c | 15. d | 19. d |
| 4. d | 8. c | 12. d | 16. c | 20. d |

335.

- | | | |
|--------------|------------------|-------------------------|
| 1. hardware | 6. shopkeeper | 11. delicatessen |
| 2. purchased | 7. guarantee | 12. shopkeeper; deposit |
| 3. buy; sale | 8. receipt | 13. shoplifting |
| 4. worth | 9. hire purchase | 14. auction |
| 5. check-out | 10. discount | 15. wide |

* 336.

- | | | | | |
|------|------|------|------|-------|
| 1. d | 3. c | 5. b | 7. c | 9. b |
| 2. b | 4. b | 6. b | 8. b | 10. c |

337.

- | | | | | |
|------|------|------|------|-------|
| 1. a | 3. d | 5. c | 7. b | 9. c |
| 2. c | 4. d | 6. a | 8. d | 10. c |

338.

- | | | | | | | | |
|------|------|------|------|-------|-------|-------|----------|
| 1. d | 3. a | 5. b | 7. a | 9. d | 11. a | 13. d | 15. a, b |
| 2. b | 4. b | 6. d | 8. c | 10. a | 12. b | 14. c | |

339.

- | | | | | |
|------|------|-------|-------|-------|
| 1. c | 5. d | 9. d | 13. d | 17. c |
| 2. d | 6. a | 10. c | 14. b | 18. d |
| 3. d | 7. c | 11. c | 15. b | 19. b |
| 4. b | 8. b | 12. d | 16. d | 20. d |

340.

- | | | | |
|------------|------------|---------------|-----------|
| 1 — barrel | 3 — basket | 9 — briefcase | 2 — cage |
| 8 — carton | 6 — crate | 4 — dustbin | 7 — purse |
| 10 — sack | 5 — trunk | | |

341.

- | | | | | | |
|------|------|------|-------|-------|-------|
| 1. b | 4. l | 7. j | 10. h | 13. f | 16. i |
| 2. n | 5. d | 8. r | 11. e | 14. q | 17. a |
| 3. p | 6. k | 9. c | 12. m | 15. g | 18. o |

342.

- | | | | |
|----------|-----------|-----------|-----------|
| 1. bunch | 4. fleet | 7. heap | 10. plate |
| 2. row | 5. bundle | 8. flight | 11. pint |
| 3. pile | 6. string | 9. deck | 12. lump |

343.

- | | | | |
|---------|---------|---------------|-------------|
| 1. tube | 5. jar | 9. set | 13. chest |
| 2. pair | 6. loaf | 10. box | 14. tin/can |
| 3. pint | 7. roll | 11. deck/pack | 15. bar |
| 4. can | 8. ball | 12. bunch | |

344.

- | | | | | |
|------|------|------|------|-------|
| 1. b | 3. c | 5. a | 7. b | 9. c |
| 2. c | 4. c | 6. c | 8. c | 10. a |

345.

- | | | |
|----------|------------|-----------|
| 1. sheet | 3. rashers | 5. volume |
| 2. roll | 4. beans | |

346.

C O I N S S
 O C E
 A S S I S T A N T
 G A T A L
 L O A F L E
 O O E X P E N S I V E
 R D I A C
 D I S C O U N T S H
 E O T Q U E U E
 R T U B E Q
 N W T I N U
 C U S T O M E R P E
 A E I S T O R E
 N E A R G I
 D H L A C E
 E

XVIII. Socializing and Pastimes

* 347.

- | | |
|----------------|-------------------------|
| 1. amused | 5. socialize |
| 2. entertain | 6. socialize |
| 3. entertained | 7. amuse/entertain |
| 4. enjoy | 8. entertained; enjoyed |

348.

- | | | | | | |
|------|------|------|------|-------|-------|
| 1. d | 3. d | 5. d | 7. a | 9. b | 11. a |
| 2. d | 4. a | 6. c | 8. c | 10. a | 12. b |

* 349.

- | | | | | |
|------|------|------|------|-------|
| 1. d | 3. d | 5. c | 7. d | 9. c |
| 2. c | 4. c | 6. d | 8. b | 10. d |

* 350.

- | | | | | |
|------|------|------|-------|-------|
| 1. e | 4. h | 7. f | 10. k | 13. c |
| 2. g | 5. i | 8. d | 11. l | |
| 3. m | 6. j | 9. b | 12. a | |

*** 351.**

- | | | |
|---------------------|------------------|--------------|
| 1. jotted/scribbled | 3. autograph | 5. print |
| 2. scrawled | 4. spelt/spelled | 6. inscribed |

352.

- | | | | | | |
|------|------|------|------|-------|-------|
| 1. d | 3. g | 5. b | 7. h | 9. a | 11. f |
| 2. k | 4. j | 6. e | 8. i | 10. c | |

353.

- | | | | | |
|------|------|-------|-------|-------|
| 1. b | 5. c | 9. a | 13. b | 17. c |
| 2. c | 6. c | 10. a | 14. b | 18. b |
| 3. b | 7. d | 11. b | 15. d | 19. b |
| 4. d | 8. b | 12. c | 16. b | |

*** 354.**

1. Printed matter: atlas, brochure, catalogue, dictionary, directory, encyclopedia, **hardback**, leaflet, lexicon, limerick, pamphlet, paperback, thesaurus
2. Handwritten matter: draft, manuscript, scroll
3. Reference books: atlas, catalogue, dictionary, directory, encyclopedia, lexicon, **thesaurus**
4. Kinds of poems: ballad, couplet, elegy, limerick, lyric, nursery rhyme, ode, sonnet

*** 355.**

- | | | | | |
|------|------|------|-------|-------|
| 1. i | 4. b | 7. l | 10. k | 13. e |
| 2. j | 5. f | 8. m | 11. g | |
| 3. a | 6. h | 9. d | 12. c | |

*** 356.**

- | | |
|----------------------------|---------------------|
| 1. bound | 4. instalment |
| 2. contents, page, chapter | 5. bibliography |
| 3. preface | 6. cross-references |

*** 357.**

- | | | | | |
|------|------|------|-------|-------|
| 1. c | 4. b | 7. d | 10. c | 13. c |
| 2. c | 5. c | 8. d | 11. d | 14. b |
| 3. c | 6. b | 9. d | 12. a | 15. d |

358.

- | | | | | |
|------|------|------|-------|-------|
| 1. a | 4. d | 7. a | 10. b | 13. b |
| 2. a | 5. d | 8. a | 11. c | 14. b |
| 3. c | 6. d | 9. a | 12. d | 15. c |

*** 359.**

- | | | | | |
|------|------|------|------|-------|
| 1. c | 3. c | 5. c | 7. d | 9. c |
| 2. a | 4. c | 6. d | 8. d | 10. a |

360.

- | | |
|--------------------------------------|----------|
| 1. articles for sale | — 48- 66 |
| 2. clothes | 16 |
| 3. the editor's comments on the news | — 1 |

- 4. films being shown locally — 22
- 5. houses for sale — 46-7
- 6. news from abroad — 10, 11
- 7. people who have died recently — 19
- 8. recently published books — 20
- 9. second-hand cars — 48-66
- 10. duties performed by the queen yesterday — 18

*** 361.**

- | | | |
|-------------|----------------|------------|
| 6 — aisle | 9 — footlights | 8 — stage |
| 4 — box | 1 — gallery | 5 — stalls |
| 3 — curtain | 7 — spotlight | 2 — wings |

362.

- | | | | | | |
|------|------|------|------|-------|-------|
| 1. a | 3. c | 5. c | 7. c | 9. a | 11. c |
| 2. d | 4. b | 6. b | 8. b | 10. d | 12. d |

363.

- | | | | | | |
|------|------|------|------|-------|-------|
| 1. c | 3. g | 5. a | 7. b | 9. f | 11. k |
| 2. l | 4. j | 6. h | 8. i | 10. d | 12. e |

**** 364.**

- | | | | | | |
|------|------|------|------|-------|-------|
| 1. b | 3. h | 5. f | 7. k | 9. j | 11. c |
| 2. e | 4. d | 6. i | 8. a | 10. l | 12. g |

365.

- | | | | | |
|------|------|------|-------|-------|
| 1. a | 4. b | 7. d | 10. d | 13. c |
| 2. a | 5. c | 8. a | 11. d | 14. c |
| 3. a | 6. b | 9. d | 12. b | 15. b |

366.

- | | | | | |
|------|------|------|------|-------|
| 1. b | 3. d | 5. g | 7. i | 9. f |
| 2. j | 4. h | 6. e | 8. c | 10. a |

367.

- a) In a circus: audience, clown, fire-eater, midget, ringmaster, sword-swallower, tightrope walker
- b) In a theatre: audience, dancer, leading lady, understudy, usher
- c) In a night club: comedian, compere, dancer, stripper

368.

- | | | | | | |
|------|------|------|------|-------|-------|
| 1. c | 3. b | 5. a | 7. b | 9. d | 11. b |
| 2. c | 4. b | 6. c | 8. c | 10. c | 12. d |

369.

- | | | | | | | | | | | |
|---|---|---|---|---|---|----------|----------|----------|---|---|
| 1 | | | | A | C | T | | | | |
| 2 | | | | R | E | H | E | A | R | S |
| 3 | | | | A | U | D | I | E | N | C |
| 4 | | | | A | P | P | L | A | U | S |
| 5 | P | L | A | Y | W | R | I | G | H | T |
| 6 | | | | P | E | R | F | O | R | M |
| 7 | | | | U | S | H | E | R | M | A |

370.

- | | | |
|------------|-----------|--------------|
| 1. violin | 3. drums | 5. xylophone |
| 2. trumpet | 4. guitar | 6. bagpipes |

** 371.

- a) string instruments: banjo, double-bass, guitar, harp, piano, violin
b) brass instruments: bugle, horn, trumpet
c) wood-wind instruments: clarinet, flute, oboe, saxophone
d) percussion instruments: cymbals, drums, tambourine, xylophone

** 372.

- | | | | |
|------|------|------|------|
| 1. b | 3. d | 5. d | 7. d |
| 2. a | 4. d | 6. d | 8. a |

* 373.

- | | | | | | |
|------|------|-------|-------|-------|-------|
| 1. c | 5. d | 9. d | 13. c | 17. d | 21. c |
| 2. b | 6. c | 10. d | 14. c | 18. b | 22. b |
| 3. b | 7. d | 11. b | 15. b | 19. b | 23. c |
| 4. c | 8. a | 12. c | 16. a | 20. c | 24. c |

374.

1	C	O	N	D	U	C	T	O	R
2		B	A	T	O	N			
3	S	Y	M	P	H	O	N	Y	
4			R	E	C	I	T	A	L
5	C	O	M	P	O	S	E	R	
6		O	P	E	R	A			
7		N	O	T	E				

** 375.

- | | | |
|---------------|-------------------|--------------------|
| 3 — bar line | 4 — key signature | 1 — staff |
| 2 — clef sign | 5 — leger line | 6 — time signature |

** 376.

- A flat* — bemol (obniżony o pół tonu)
A sharp — A z krzyżykiem (ais; podwyższony o pół tonu)
clef — klucz wiolinowy
major key — w tonacji dur
minor key — w tonacji moll
score — partytura
staff (or stave) — pięciolinia

377.

- | | | | |
|------------------|-------------|----------|-----------|
| 1. disc-jockey | 4. sleeves | 7. beat | 10. tempo |
| 2. single | 5. album | 8. lyric | 11. hit |
| 3. LP (or album) | 6. juke-box | 9. tune | |

378.

- | | | | | |
|------|------|------|-------|-------|
| 1. b | 4. a | 7. d | 10. c | 13. b |
| 2. d | 5. b | 8. c | 11. c | 14. a |
| 3. a | 6. d | 9. c | 12. a | 15. a |

379.

- | | | | |
|------|------|------|------|
| 1. b | 3. d | 5. a | 7. a |
| 2. c | 4. b | 6. b | 8. b |

* 380.

The Parts of a Camera

A camera is a box with an aperture, or small OPENING, at one end. The APERTURE lets light into the camera just as a window lets LIGHT into a room. A shutter over the opening works like a Venetian blind. When you take a PICTURE, you press the SHUTTER RELEASE BUTTON. The SHUTTER opens, lets light into the camera, and quickly closes.

Light passes through a glass LENS when it enters the camera. The lens bends the LIGHT RAYS so that they form a sharp image on a section of the film. The IMAGE appears on the film only after the film has gone through a complicated chemical process called DEVELOPING.

Before TAKING a picture, you look through the VIEWFINDER of the camera to make sure that all of your subject will appear in the picture. After taking the picture, you WIND the FILM on to get the camera set for the next picture. Most cameras are equipped with a HOLDER for flashbulbs. The use of FLASHBULBS adds extra light to a scene, especially INDOORS.

381.

- | | | | | |
|------|------|------|-------|-------|
| 1. a | 4. d | 7. c | 10. b | 13. b |
| 2. d | 5. b | 8. b | 11. a | 14. a |
| 3. c | 6. d | 9. b | 12. d | |

382.

1				C	A	R	T	O	O	N			
2			S	U	B	T	I	T	L	E	S		
3			D	U	B	B	I	N	G				
4		T	H	R	I	L	L	E	R				
5			D	O	C	U	M	E	N	T	A	R	Y
6	S	C	R	E	E	N	P	L	A	Y			

383.

- | | | |
|-----------|------------|------------|
| 1. TV set | 3. switch | 5. speaker |
| 2. screen | 4. cabinet | 6. aerial |

* 384.

- | | | | | |
|------|------|------|-------|-------|
| 1. a | 4. d | 7. b | 10. c | 13. b |
| 2. b | 5. a | 8. c | 11. b | 14. c |
| 3. b | 6. c | 9. d | 12. a | 15. b |

385.

- | | | | | | |
|------|------|-------|-------|-------|-------|
| 1. b | 5. a | 9. c | 13. c | 17. b | 21. b |
| 2. a | 6. d | 10. c | 14. c | 18. c | 22. d |
| 3. b | 7. c | 11. b | 15. c | 19. c | 23. a |
| 4. d | 8. a | 12. c | 16. b | 20. c | 24. b |

386.

- | | | |
|--------------|-------------|---------------|
| 1. landscape | 2. portrait | 3. still life |
|--------------|-------------|---------------|

* 387.

1. palette 2. canvas 3. easel 4. brush

** 388.

1. j 3. k 5. a 7. c 9. l 11. d
 2. i 4. b 6. g 8. e 10. f 12. h

389.

1. square 3. circular 5. oval
 2. rectangular 4. triangular

* 390.

1									S	C	U	L	P	T	U	R	E			
2															R	E	L	E	F	
3			I	M	P	R	E	S	S	I	O	N	I	S	M					
4																B	R	U	S	H
5									E	N	G	R	A	V	E					
6											M	A	R	B	L	E				
7										C	A	N	V	A	S					
8									L	A	N	D	S	C	A	P	E			
9											S	T	O	N	E					

391.

1. spades 2. hearts 3. clubs 4. diamonds

392.

1. king of spades 3. queen of diamonds
 2. jack (or knave) of hearts 4. ace of clubs

* 393.

1. picture card 4. a pack of cards 7. dice
 2. joker 5. dealing 8. casino
 3. trump 6. shuffle 9. blackjack or pontoon

394.

1. b 3. d 5. d 7. b 9. d
 2. c 4. d 6. b 8. a 10. c

* 395.

1. queen 3. castle or rook 5. knight
 2. king 4. bishop 6. pawn

XIX. Sports

396.

- | | | |
|-----------------------|----------------|--------------|
| 1. football or soccer | 5. sailing | 9. high jump |
| 2. rugby | 6. swimming | 10. skating |
| 3. basketball | 7. volley-ball | |
| 4. hockey | 8. gymnastics | |

397.

- | | |
|----------------|----------------|
| 5 — rowing | 1 — fencing |
| 3 — javelin | 4 — relay race |
| 6 — pole vault | 7 — wrestling |
| 2 — hurdles | |

*** 398.**

- | | | |
|-------------------------------|---------------|----------------------------|
| 1. soccer | 6. goal | 11. referee |
| 2. coach | 7. kick-off | 12. fair |
| 3. footballer | 8. score | 13. fouls |
| 4. football ground (or pitch) | 9. draw | 14. free (or penalty) kick |
| 5. captain | 10. opponents | 15. league |

399.

SPORTS	TEAM	INDIVIDUAL	COMBATIVE	INDOOR	OUTDOOR
rugby	+				+
relay racing	+			+	+
jumping		+		+	+
golf		+			+
fencing		+	+	+	
skiing		+			+
boxing		+	+	+	
cricket	+				+
riding		+			+
soccer	+				+

*** 400.**

- | | | |
|----------------|----------------|---------------------|
| 1. goal keeper | 3. centre back | 5. midfield players |
| 2. right back | 4. left back | 6. strikers |

*** 401.**

- | | | | | |
|------|-------|-------|-------|-------|
| 1. a | 6. c | 11. a | 16. b | 21. d |
| 2. b | 7. c | 12. c | 17. a | 22. b |
| 3. a | 8. c | 13. c | 18. a | 23. a |
| 4. d | 9. d | 14. c | 19. c | 24. d |
| 5. a | 10. d | 15. a | 20. c | 25. d |

* 402.

1. e 3. c 5. h 7. b 9. b
 2. a 4. h 6. f 8. d 10. g

403.

	GAME	MATCH	TOURNAMENT	COMPETITION	RACE	CONTEST
football	+	+				
skiing				+	+	
chess	+		+			
tennis	+	+	+			
shooting						+
horse					+	
boxing		+				
motor					+	
fencing						+

404.

1. breast stroke 2. back stroke 3. crawl 4. butterfly

* 405.

- 6 — bridle 5 — harness 2 — reins 1 — riding crop
 3 — saddle 4 — stirrup

* 406.

	ball	bat	bow	club	gloves	oar	racket	rod	stick
angling								+	
archery			+						
baseball	+	+			+				
boxing					+				
cricket	+	+			+				
golf	+			+					
hockey									+
ping pong	+	+							
rowing						+			
squash	+						+		

* 407.

1. d 6. d 11. b 16. b 21. c
 2. b 7. a 12. b 17. a 22. a
 3. a 8. c 13. b 18. b 23. c
 4. c 9. c 14. c 19. d 24. d
 5. b 10. b 15. b 20. a 25. a

INDEX

A

- accessories (clothes), 60
- activities (military), * 25
- acting and actors, 265, 366, 367
- advertising, 328
- aircraft, kinds of, 1
- aircraft, parts of, ** 4
- AIR TRAVEL**, 1—5
 - aircraft, kinds of, 1
 - aircraft, parts of, ** 4
 - air travel, 2, 3, 5
- alcoholic drinks, ** 125
- ANIMALS**, 6—22
 - animals, ** 6, ** 9, 11, * 13, 19, 22
 - birds, ** 8
 - coats of, 15
 - collective nouns, ** 16
 - gender, ** 7
 - habitat, ** 12
 - insects, ** 20
 - pets, 17, * 18
 - protection, 21
 - sounds, * 14
 - young, ** 10
- ARMY**, 23 32
 - army, 23, 24, 25, 26, * 27, ** 28, * 30, 32
 - military activities, * 25
 - military commands, 31
 - weapons, 29
- art, 379, * 380, 385, 386, * 387, ** 388, 389, * 390

B

- banks, See **MONEY AND BANKING**
- birds, ** 8
- bits and pieces (education), 113, 114, 115
- boats, kinds of, 312, 314
- boats, parts of, ** 315, ** 317
- body, parts of, 155, 156, * 157, 158, ** 159, 160, 161, * 162, 163, * 164
- books, 352, 353, * 354, * 355, * 356, * 357
 - kinds of, 352, * 354
 - parts of, * 355
- building a house, 232, 234
- buying, See **SHOPPING**
- buying (clothes), 53, 54
- buying (a house/flat), * 235, * 236, ** 237, 238

C

cereals, ** 121, ** 123

Catholicism, * 305, ** 310

church, 303, ** 308; See RELIGION

CLOTHING, 33—70

accessories, 60

buying clothes, 53, 54

clothing, 44, * 55, 56

colours, 69, 70

elegance, 38, 57

fabric care, 45, 46, 47, 48

fasteners, 49, 50

footwear, 61, * 62, 63, 64, 65

hair and headgear, 66, 67, * 68

items of clothing, 33, 34, 35, 36, 37, 39

jewellery and ornaments, 58, 59

kinds of material, 40, 41, 42, 43

sewing, 51, 52

coats (of animals), 15

collective nouns (animals), ** 16

colours, 69, 70

commands (military), 31

complaints (shopping), 338

connectors, 265, 266

containers, 340, 341

cooking, See FOOD, COOKING, AND RESTAURANTS

court, 78, 79, 80

CRIME AND PUNISHMENT, 71 85

crime, * 71

crime and punishment, * 84, 85

law breakers, 72, 73, * 74, * 75, 76

police, 77

punishment, * 81, 82, * 83

trial, 78, 79, 80

criminals, 72, 73, * 74, * 75, 76

D

decorating, * 272, * 273

dental care, 165, * 166

diet, 167, * 168, * 169

disciplines (sports), 396, 397, 398

discases, ** 170, 171, 172, ** 173, ** 174, 175

drugs, 176, 177, * 178, * 179, * 180, 181, * 182, * 183

E

EDUCATION, 86—116

bits and pieces, 113, 114, 115

education, 116

enrolment, 87, * 88, * 89

examinations, 103, 104, 105, * 106

homework, 92, * 93

language learning, 107, * 108, 109

lectures, 90, * 91

punctuation marks, ** 110
pupils, 86
scholarship, 111, * 112
students, 94, 95, * 96, 97
subjects, 101, * 102
teachers, 97, 98, 99, * 100, ** 101, ** 102
elegance, 38, 57
engagements, kinds of sports, 403
enrolment, 87, * 88, * 89
entertaining, * 347, 348, * 349
equipment (sports), * 402, * 406
examinations, 103, 104, 105, * 106
expressions, musical, 375, 376

F

fabric care, 45, 46, 47, 48
fasteners, 49, 50
film, 381, 382
fish (food), ** 123, ** 125
flats. See HOMES AND HOUSES
flowers, 150, 151, 152

FOOD, COOKING, AND RESTAURANTS, 117—145

alcoholic drinks, ** 125
cereals, ** 121, ** 123
cooking, 133, 134, 135, * 136, ** 137, * 138, 139, 145
fish, ** 123, ** 125
food, 117, 118, 119, 120, ** 121, * 122, ** 123, 144, 145
game, ** 125
herbs, ** 123, ** 125
meals, ** 125, 126
menu, * 142
methods of cooking, 134, 144
pasta, ** 125
pots and pans, * 128, 129, 130, 131, * 132
restaurants, 140, 141, * 142, * 143, 144, 145
shellfish, ** 125
spices, ** 125
taste, 124, * 127
kinds of wine, ** 125
football, * 399, ** 400, * 401
footwear, 61, * 62, 63, 64, 65
furniture, 253, 254, 255, * 256, 257, 258, 259, 260, * 261, 262

G

gambling, 391, 392, * 393, 394, * 395
game (food), ** 125
garden tools, 148
GARDENING, 146—154
flowers, 150, 151, 152
garden tools, 148
gardening, 146, * 147, 149
vegetables, 153, 154
gender (of animals), ** 7

H

- habitat (of animals), ** 12
- hair and headgear, 66, 67, * 68
- health, 184, 185, 186, * 187, 188, 189, * 190, 191
- HEALTH AND MEDICINE, 155 215**
 - body, 155, 156, * 157, 158, ** 159, 160, 161, * 162, 163, * 164
 - dental care, 165, * 166
 - diet, 167, * 168, * 169
 - diseases, ** 170, 171, 172, ** 173, ** 174, 175
 - drugs, 176, 177, * 178, * 179, * 180, 181, * 182, * 183
 - health, 184, 185, 186, * 187, 188, 189, * 190, 191
 - injuries, * 192, * 193, * 194, 195, * 196
 - mental health, 197, * 198
 - patients, 199, * 200, * 201
 - smoking, 202
 - specialists, 203, 204, ** 205, ** 206, ** 207
 - symptoms, 208, ** 209, ** 210, ** 211, * 212, 213, 214, * 215
- herbs (food) ** 123, ** 125, (plants) ** 296
- HISTORY, 216, * 217, 218, 219, 220, 221, * 222, * 223, * 224**
- hobbies, See **SOCIALIZING AND PASTIMES**
- home, See **HOUSES AND HOMES**
- homework (education), 92, * 93
- horse riding, * 405
- household appliances, 263, * 264
- household chores, 270, * 271
- houses, 249, 250, 251, * 252
- HOUSES AND HOMES, 225--278**
 - building a house, 232, 234
 - buying a house/flat, * 235, * 236, ** 237, 238
 - connectors, 265, 266
 - decorating, * 272, * 273
 - furniture and fittings, 253, 254, 255, * 256, 257, 258, 259, 260, * 261, 262
 - household appliances, 263, * 264
 - household chores, 270, * 271
 - parts of a house/flat, 243, * 244, 245, 246, 247, * 248
 - places to live, 225, 226, 227, 228, 229, 230, 231
 - renting a flat/house, 239, ** 240, 241, * 242
 - tools, 267, 268, 269
 - towns and villages, 274, 275, * 276, * 277, 278

I

- illness, See **diseases**
- injuries, * 192, * 193, * 194, 195, * 196
- insects, ** 20
- instruments (musical) ** 371, ** 372
- items of clothing, 33, 34, 35, 36, 37, 39

J

- jewellery, 58, 59
- journeys, * 320
- justice, See **CRIME AND PUNISHMENT**

L

language learning, 107, * 108, 109
law, See CRIME AND PUNISHMENT
law breakers, 72, 73, * 74, * 75, 76
lectures, 90, * 91
life-cycle (of plants), ** 294, ** 296

M

magazines, 358, * 359, 360
material (cloth), kinds of, 40, 41, 42, 43
meals, ** 125, 126
medicine, See HEALTH AND MEDICINE
mental health, 197, * 198
menu, * 142
methods of cooking, 134, 144
MONEY AND BANKING, 279 -287
 banks, 285, 286, * 287
 money, 279, 281, ** 283
 money expressions, ** 280, ** 282, 284
movies, See film
music, 370, ** 371, ** 372, * 373, 374, ** 375, ** 376, 377, 378
musical expressions, ** 375, ** 376
musical instruments, ** 371, ** 372

N

newspapers, 358, * 359, 360

O

ornaments (clothing), 58, 59

P

painting, 386, * 387, ** 388, 389, * 390
parts of house/flat, 243, * 244, * 245, 246, 247, * 248
pasta (food), ** 125
pastimes, See SOCIALIZING AND PASTIMES
patients, 199, * 200, * 201
pets, 17, * 18
photography, 379, * 380
places to live, 225, 226, 227, 228, 229, 230, 231
PLANTS, 288 -298
 herbs, ** 296
 life cycle, ** 294, ** 296
 plants, ** 288, 289, 290, * 295, * 297
 trees, ** 291, ** 292, * 293
police, 77
pop-music 377, 378
POST OFFICE AND TELEPHONES, 298
 post office, 298, 299, 300
 telephones, 301, 302
 telephone etiquette, 302
pots and pans, * 128, 129, 130, 131, * 132
prices (shopping), 334, * 336, 337

priests, ** 306, * 307
protection (of animals), 21
punctuation, ** 110
punishment (law), * 81, 82, * 83
pupils (education), 86

Q

quantities (shopping), 342, 343, 344, 345

R

reading, See books

RELIGION, 303—311

Catholicism, * 305, ** 310
churches, 303, ** 308
priests, ** 306, * 307
religion, 304, * 305, ** 306, 309, * 311
renting a flat/house, 239, ** 240, 241, * 242
restaurants, See FOOD, COOKING AND RESTAURANTS

S

salesmen, * 333
scholarships, 111, * 112
SEA TRAVEL, 312—320
journeys, * 320
kinds of boats/ships, 312, 313, 314, * 319
parts of boats/ships, ** 315, ** 317, * 319
sea travel, * 318, * 320

set, parts of a tv, 383

sewing, 51, 52

shellfish (food), ** 125

shoes, See footwear

school, See EDUCATION

ships, kinds of, 312, 314, * 319

ships, parts of, ** 315, ** 317, * 319

SHOPPING, 321—346

advertising, 328
complaints, 338
containers, 340, 341
doing shopping, 329, 330, * 331, * 332
goods, 339
price and value, 334, * 336, 337
quantities, 342, 343, 344, 345
salesman, * 333
shops, 321, 322, * 323, 324, 325, 326, * 327, 346
shopping (clothes), 53, 54
shops, kinds of, 322, * 323, 324, 325, 326, * 327
smoking, 202
soccer, See football
SOCIALIZING AND PASTIMES, 347—391
art, 379, * 380, 385, 386, * 387, ** 388, 389, * 390
painting, 386, * 387, ** 388, 389, * 390
photography, 379, * 380

books, 352, 353, * 354, * 355, * 356, * 357
 kind of, 352, 354
 parts of, * 355, * 356
 entertaining, * 347, 348, * 349
 film, 381, 382
 gambling, 391, 392, * 393, 394, * 395
 magazines, 358, * 359, 360
 music, 370, ** 371, ** 372, * 373, 374, ** 375, ** 376, 377, 378
 musical expressions ** 375, ** 376
 instruments, ** 371, ** 372
 pop-music, 377, 378
 newspapers, 358, * 359, 360
 painting, 386, * 387, ** 388, 389, * 390
 photography, 379, * 380
 socializing, * 347, 348, * 349
 television, 381, 383, * 384
 parts of a tv set, 383
 theatre, * 361, 362, 363, ** 364, 365, 366, 367, 268, 369
 acting and actors, 365, 366, 367
 parts of, * 361, 362, 363, ** 364
 writing, ways of, * 350, * 351
 sounds (of animals), * 14
 specialists (in medicine), 203, 204, ** 205, ** 206, ** 207
 spiccs, ** 125
SPORTS, 396—407
 disciplines, 396, 397, 399
 engagements, kinds of, 403
 equipment, * 402, * 406
 football, * 398, * 400, * 401
 horse-riding, * 405
 soccer, See football
 swimming, 404
 students, 94, 95, * 96, 97
 subjects (school), 101, * 102
 swimming, 404
 symptoms, 208, ** 209, ** 210, ** 211, * 212, 213, 214, * 215

T

taste (clothes), 38, 57
 taste (food), 124, * 127
 teachers, 97, 98, 99, * 100, ** 101, ** 102
 telephone, 301, 302
 television, 381, 383, * 384
 theatre, * 361, 362, 363, ** 364, 365, 366, 367, 368, 369
 parts of, * 361, 362, 363, ** 364
 tools, 267, 268, 269
 tools (garden), 148
 towns and villages, 274, 275, * 276, * 277, 278
 travel, See AIR TRAVEL, SEA TRAVEL
 trees, ** 291, ** 292, *293
 trial (legal), 78, 79, 80

U

university, See EDUCATION

V

vegetables, 153, 154

W

washing (clothes) 45, 46; See fabric care

weapons, 29

wine (kinds of), ** 125

writing, ways of, * 350, * 351

Y

young (of animals), ** 10

Tests in English jest zbiorem testów słownikowych na poziomie średnio-zaawansowanym i zaawansowanym.

Zbiór zawiera trzy rodzaje testów.

Największą grupę stanowią testy pozwalające sprawdzić znajomość słownictwa najczęściej stosowanego przez przeciętnych użytkowników języka angielskiego w Wielkiej Brytanii czy USA, tzn. około 10 tysięcy wyrazów (dla porównania np. *Oxford English Dictionary* zawiera prawie pół miliona wyrazów).

Grupa druga to testy oznaczone gwiazdką (*) zawierające wyrazy subiektywnie określone jako mniej przydatne. Większość uczących się może je pominąć, powinna jednak wiedzieć, że znajomość użytego tam słownictwa i posługiwanie się nim świadczy o erudycji danej osoby. Z pewnością testy takie będą wykorzystywane przez „zbierających” wyrazy hobbystów lub przygotowujących się do zdawania Cambridge Proficiency in English Examination.

Inna niewielka grupa testów oznaczonych dwiema gwiazdkami (**) to testy z wyrazami specjalistycznymi. Do ich rozwiązania potrzebna jest dokładniejsza wiedza szczegółowa z zakresu danej dyscypliny (choć nigdy na poziomie wyższym niż zakłada to program liceum ogólnokształcącego). W przypadku takich testów nieprawidłowa odpowiedź może świadczyć bądź o nieznajomości wyrazu, bądź o nieznajomości przedmiotu.

Na przykład w zdaniu:

Which of these is not a reptile?

a) alligator b) frog c) lizard d) turtle

student może znać wszystkie wyrazy, ale nie potrafi odróżnić gada od płaza. Najwięcej takich przykładów znajduje się w rozdziałach II, III, V, IX, XII i XVIII. Uważając, że studium chce poznać i przećwiczyć słownictwo z różnych dziedzin, zdecydowano się włączyć do zbioru i takie testy.

1997 r. — Cena zł 14,00



SLB1985i)